

AXIS C8033 Network Audio Bridge

User Manual

AXIS C8033 Network Audio Bridge

Safety information

Safety information

Hazard levels

▲DANGER

Indicates a hazardous situation which, if not avoided, will result in death or serious injury.

▲WARNING

Indicates a hazardous situation which, if not avoided, could result in death or serious injury.

▲CAUTION

Indicates a hazardous situation which, if not avoided, could result in minor or moderate injury.

NOTICE

Indicates a situation which, if not avoided, could result in damage to property.

Other message levels

Important

Indicates significant information which is essential for the product to function correctly.

Note

Indicates useful information which helps in getting the most out of the product.

AXIS C8033 Network Audio Bridge

Table of Contents

Safety information	2
Hazard levels	2
Other message levels	2
Product overview	4
Connectors and Buttons	4
LED Indicators	4
How to access the product	6
How to access the product from a browser	6
How to access the product from the internet	6
How to set the root password	6
How to set up the product	7
How to perform a basic setup	7
Audio	8
Overview	8
System settings	9
Device settings	9
Clips	10
Detectors	12
Audio Alarm Level	12
Activity	12
Voice over IP (VoIP)	13
VoIP Overview Page	13
Configure the SIP Settings	13
The Account Settings Page	15
About applications	19
About application licenses	19
How to upload and start an application	19
Application Considerations	19
AXIS Audio Player	20
About events	21
How to set up action rules	21
How to add recipients	22
How to create schedules	23
How to set up recurrences	24
About languages	25
About system options	26
Security	26
Date & Time	27
Network	28
Storage	32
Ports & Devices	32
Maintenance	33
Support	33
Advanced	34
How to reset to factory default settings	34
Troubleshooting	35
How to check the current firmware	35
How to upgrade the firmware	35
Symptoms, possible causes and remedial actions	35
Specifications	37

AXIS C8033 Network Audio Bridge

Product overview

Product overview

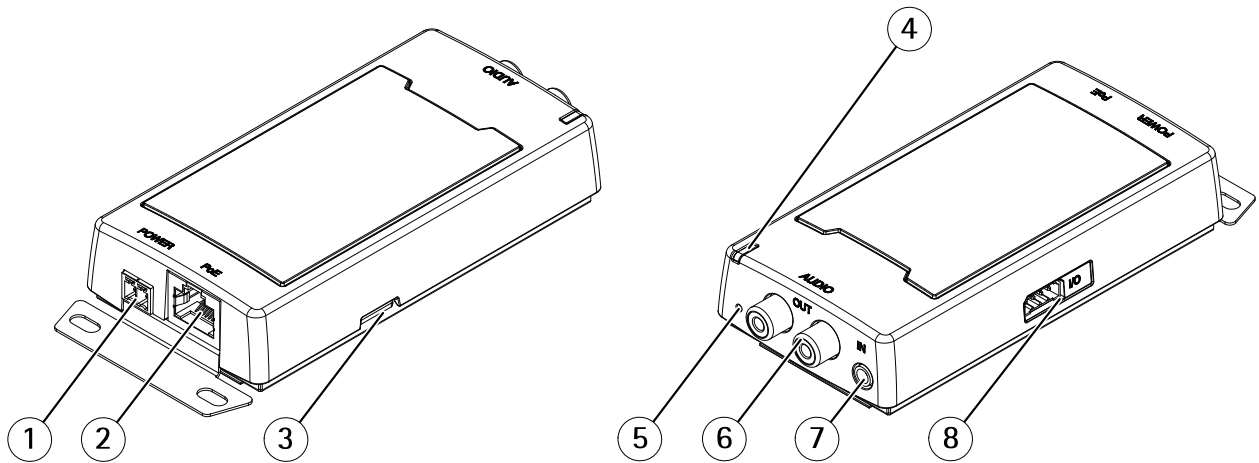

- 1 Power connector (DC)
- 2 Network connector
- 3 SD memory card slot
- 4 Status LED indicator
- 5 Control button
- 6 RCA connector
- 7 Audio-in connector
- 8 I/O connector

Connectors and Buttons

Network connector

NOTICE

The product shall be connected using a shielded network cable (STP). All cables connecting the product to the network shall be intended for their specific use. Make sure that the network devices are installed in accordance with the manufacturer's instructions. For information about regulatory requirements, see the Installation Guide at www.axis.com.

Control button

For location of the control button, see *Product overview on page 4*.

The control button is used for:

- Resetting the product to factory default settings. See *page 34*.
- Connecting to an AXIS Video Hosting System service. See *page 29*. To connect, press and hold the button for about 3 seconds until the Status LED flashes green.
- Connecting to AXIS Internet Dynamic DNS Service. See *page 29*. To connect, press and hold the button for about 3 seconds.

LED Indicators

Status LED	Indication
Unlit	Unlit for normal operation.

AXIS C8033 Network Audio Bridge

Product overview

Green	Steady green for normal operation.
Amber	Steady during startup and when restoring settings.
Red	Slow flash for failed upgrade.
Red/Green	Flashes fast between red/green when identifying an audio device is selected.

AXIS C8033 Network Audio Bridge

How to access the product

How to access the product

To install the Axis product, see the Installation Guide supplied with the product.

How to access the product from a browser

1. Start a web browser.
2. Enter the IP address or host name of the Axis product in the browser's address field.

To access the product from a Mac computer (OS X), go to Safari, click on Bonjour and select the product from the drop-down list.

Note

To show Bonjour as a browser bookmark, go to **Safari > Preferences**.

3. Enter your username and password. If this is the first time the product is accessed, the root password must first be configured.

How to access the product from the internet

Once connected, you can access the product on your local network (LAN).

To access the product from the internet you must configure your network router to allow incoming data traffic to the product. To do this, enable the NAT-traversal feature, which will attempt to automatically configure the router to allow access to the product. This is enabled from .

For more information, see *NAT traversal (port mapping) for IPv4 on page 30*.

For Technical notes on this and other topics, visit the Axis Support web at www.axis.com/support

See also AXIS Internet Dynamic DNS Service at www.axiscam.net

How to set the root password

To access the Axis product, you must set the password for the default administrator user **root**. This is done in the **Configure Root Password** dialog, which opens when the product is accessed for the first time.

To prevent network eavesdropping, the root password can be set via an encrypted HTTPS connection, which requires an HTTPS certificate. HTTPS (Hypertext Transfer Protocol over SSL) is a protocol used to encrypt traffic between web browsers and servers. The HTTPS certificate ensures encrypted exchange of information. See *HTTPS on page 26*.

The default administrator user name **root** is permanent and cannot be deleted. If the password for root is lost, the product must be reset to the factory default settings. See *How to reset to factory default settings on page 34*.

To set the password via a standard HTTP connection, enter it directly in the dialog.

To set the password via an encrypted HTTPS connection, follow these steps:

1. Click **Use HTTPS**.
A temporary certificate (valid for one year) is created, enabling encryption of all traffic to and from the product, and the password can now be set securely.
2. Enter a password and then re-enter it to confirm the spelling.
3. Click **OK**. The password has now been configured.

AXIS C8033 Network Audio Bridge

How to set up the product

How to set up the product

The Axis product can be configured by users with administrator rights. Go to **Setup > Basic Setup > 1 Users** to administer users.

- Administrators have unrestricted access to all settings.

See also the online help .

How to perform a basic setup

Basic Setup provides shortcuts to the settings that should be made before using the Axis product:

1. Users. See *page 26*.
2. TCP/IP. See *page 28*.
3. Date & Time. See *page 27*.
4. VoIP Settings. See *page 13*.

AXIS C8033 Network Audio Bridge

Audio

Audio

The audio settings can be used to adjust audio quality. You can configure the following:

- Overview. See *Overview*.
- System settings. See *page 9*.
- Device settings. See *Device settings*.
- Clips. See *Clips*.

Overview

This page provides an overview of the leader audio device and the audio devices added to the zone.

Connect several audio devices into a zone, and manage music playlists, streams, announcements, scheduling and volume settings from a single audio device.

Log in to the audio device that you want to set as the leader in the zone, and connect all the other audio devices as followers.

About announcements

In the schedule it is possible to overlap your playlist with pre-recorded announcements. It is also possible to do live announcements when playing a playlist, see *Voice over IP (VoIP)*.

In both cases the music will mute during the announcement.

About standalone mode

These settings are available in standalone mode (no audio devices are added into the zone).

Use the slider to increase or decrease the volume.

To identify the audio bridge, click on the tone and the LED on the audio bridge will flash fast between green and red.

How to set the volume for audio devices in a zone

Go to **Audio > Overview**.

These settings are available when the audio device is connected to at least one more audio device.

1. Use the slider **System** under **Volume** to set system volume for max announcement sound level
2. Set volume in Axis Audio Player for the background music sound level.
3. If needed use the sliders beside the followers to adjust the balance between speakers by decreasing the individual volume for the louder speakers and repeat step 1 and 2.

How to identify audio devices in a zone

Go to **Audio > Audio Overview**.

Identify all audio devices in the zone – Click the upper tone and all speakers that are connected to the system will play a sound in a sequence. All type of audio devices will also flash its LED repeatedly in green and red.

Identify a single audio device in the zone – Click the tone beside a follower. A speaker will make a sound. All type of audio devices will also flash its LED repeatedly in green and red.

AXIS C8033 Network Audio Bridge

Audio

System settings

This page provides options to setup a network audio device system.

How to set up an audio device system (zone)

1. Log in to the audio device that you want to set as the leader in the zone.
2. Go to **Audio > System Settings**.
3. Rename your leader audio device:
 - To edit the leader audio device, click the pencil
 - Set audio device name and enter username and password.
 - If the systems includes more than 50 audio devices, change to **Multicast**.
 - Select **Enable broadcast of analog audio input** to enable the audio from a connected analog audio source to be played.
 - Click **Apply**
4. Add audio devices to the zone:
 - Under **Available audio devices**, click the plus sign to add a audio device to the zone. If your device is not listed, click **Add device manually** to add the device.
 - For each audio device: Set audio device name and enter username and password.
 - Click **Apply**.

Device settings

To set up the Axis product, go to **Audio > Device Settings**.

Audio Modes

The Axis product supports the following audio modes:

- **Full duplex** – Simultaneous two-way audio allowing the Axis product to transmit and receive audio at the same time. There is no echo cancellation; if feedback loops appear, try moving the microphone or the speaker.
- **Half-duplex** –Audio can be transmitted to and from the Axis product but only in one direction at a time.
- **Simplex – Speaker only** – Audio is transmitted from a client to the Axis product. This is the default audio mode.
- **Simplex – Microphone only** – Audio captured by the product microphone is transmitted from the Axis product to one or more clients.

To set the audio mode, go to **Audio > Device Settings** and select the desired mode from the **Audio mode** drop-down list.

Audio Input

Configure the audio input settings under **Audio> Device Settings**.

Source: Select **Microphone** to use an external microphone or **Line** to use a Line in device, e.g. an audio mixer for multiple microphones or a microphone with a built-in amplifier, as audio source.

Use the **Input gain** to control the volume (dB Full Scale) of the audio input. If the sound is too low, choose a higher dB, to amplify the sound. If the sound is too high, choose a lower dB. The **Level bar** gives a visual representation of the audio signal level in dB relative to the full-scale input level.

AXIS C8033 Network Audio Bridge

Audio

- Green – the signal is at a good level.
- Yellow – the signal is becoming distorted.
- Red – the signal is distorted.

Use the **Encoding** option to select digital audio encoding format.

- **AAC** is used for encoding only in the Axis product. For decoding, no license is included in the Axis product.
- **G711** is an unlicensed standard codec that is useful when integrating audio into a VoIP system
- **G726** is an unlicensed speech codec that is most commonly used within the security industry.

The **Sample rate** defines the number of times per second the sound is sampled. A higher sample rate will provide better audio quality, but also requires a greater bandwidth.

Set the required **Bit rate** depending on the selected encoding. A higher bit rate will give better audio quality. A lower bit rate may have latency or delay, but will require less bandwidth.

For more information about these settings, please see the online help .

Audio Output

Configure the audio output settings under **Audio > Device Settings**.

Output gain – Move the slider to adjust the volume of the audio output. To mute the sound, move the slider to the left end of the slider.

Clips

Audio Clip List

Audio clips can be played when an event occurs. Audio clips are created by uploading a sound file to the Axis product. To add, play, download, modify or remove audio clips, go to **Audio > Audio Clips**. For more information see the online help .

- **Add** – To add an audio clip, click **Add**, select the **Upload** radio button and click **Browse**. Navigate to the desired file and click **Upload** to upload the audio clip.
 - The following audio formats are supported: .au G.711 u-law, 8-bit, mono (8, 16 kHz) , .wav PCM, 16-bit, mono (8, 16, 32 kHz) and MP3.
 - The typical file size is 10MB.
- **Play** – To play an audio clip, select an audio clip in the **Audio Clip List** and click **Play**. Audio clips can only be played if the audio device is not streaming audio or playing another clip.
- **Stop** – To stop an audio clip, select it and click **Stop**.
- **Download** – To download a recording to a hard drive or network disk, select it and click **Download**.
- **Modify** – To change the name of the audio clip, select it and click **Modify**.
- **Remove** – To remove an audio clip, select it and click **Remove**.

To configure the Axis product to play audio clips when an event occurs, an action rule must be set up. For more information, see *About events on page 21*.

Configure Audio Clip Link

To create a link to a configured audio clip:

AXIS C8033 Network Audio Bridge

Audio

1. Select an audio clip from the list.
2. If you want to play several clips with similar file names in an random order, replace parts of the file name in the audio clip field with an asterisk. For example: to play the audio clips `sound01.mp3` and `sound02.mp3` write `sound*` in the audio clip field.
3. Set the audio clip configurations.
4. Select the copy icon to copy the link.

AXIS C8033 Network Audio Bridge

Detectors

Detectors

Audio Alarm Level

Event types in the Axis product can be set to use this level as a trigger. Each individual event type can be configured to trigger if the sound level rises above, falls below or passes the set value.

The alarm level can be set in the range 0-100, where 0 is the most sensitive and 100 the least sensitive.

When setting the alarm level use the Activity indicator as a guide. For best detection, place the level so that there is green below the bar with a small amount of red above the bar.

Activity

Detected audio is indicated by colored peaks in the Activity indicator. An event is triggered when detected audio rises above, falls below or passes the Audio Alarm Level specified, which is represented by the bar.

Note

Audio detection level must be set before creating an Action Rule that triggers on audio detection.

AXIS C8033 Network Audio Bridge

Voice over IP (VoIP)

Voice over IP (VoIP)

Voice over IP (VoIP) is a group of technologies that enables voice communication and multimedia sessions over IP networks. In the Axis product, VoIP is enabled through the Session Initiation Protocol (SIP) and Dual-Tone Multi-Frequency (DTMF) signaling.

To open the product's VoIP pages, go to **Setup > VoIP**.

The VoIP settings include the following pages:

- **VoIP Overview.** See *VoIP Overview Page* on page 13.
- **SIP Settings.** See *Configure the SIP Settings* on page 13.
- **Account Settings.** See *Create or Edit Accounts* on page 15.

The VoIP settings can be configured by users with administrator rights.

VoIP Overview Page

The VoIP Overview page shows basic information about the SIP, VoIP action rules, and Account Settings.

- **SIP Settings** – Shows the basic Session Initiation Protocol (SIP) settings, and indicates whether SIP is enabled and allows incoming calls or not.

To change the settings, click **Configure** or go to **VoIP > SIP Settings**. For more information, see *Configure the SIP Settings* on page 13.

- **Account Settings** – Shows an overview of the SIP account settings. See also *The Account Settings Page* on page 15.

To create a new account, test an account, or change the account settings, click **Configure** or go to **VoIP > Account Settings**. For more information, see *Create or Edit Accounts*.

Configure the SIP Settings

Session Initiation Protocol (SIP) is a text-based protocol, similar to HTTP and SMTP, for interactive communication sessions between users. The sessions can include voice and video elements. See *About SIP Addresses* on page 18.

Before the Axis product can be used to make and receive calls, you need to configure the SIP settings. This includes enabling SIP, configuring the ports, and setting the rules for Network Address Translation (NAT) traversal.

To configure the SIP settings:

1. Go to **Setup > VoIP > SIP Settings**.
2. Click **Start** to start the SIP Setup Assistant. For more information, see *SIP Setup Assistant* on page 14.

Or:

1. Go to **Setup > VoIP > SIP Settings**.
2. Select **Enable SIP**.
3. To allow the Axis product to receive calls, select **Allow incoming SIP calls**.
4. Enter the **SIP port number** and the **SIP TLS port number**. For more information, see *Port Settings* on page 14.
5. Select the protocols you want to enable for NAT traversal. See *Network Address Translation (NAT) Traversal (port forwarding)* on page 14.
6. Configure the value for **Registration interval** and **Max call duration** if needed.

AXIS C8033 Network Audio Bridge

Voice over IP (VoIP)

7. Click Save.

NOTICE

Allowing incoming calls enables the AXIS product to accept calls from any device connected to the network. It is recommended to disable incoming calls for products that are accessible from public networks or the Internet.

Note

Even if you choose to not enable SIP, you can configure the SIP settings. But remember that when SIP is disabled, you cannot make or receive calls.

SIP Setup Assistant

The SIP Setup Assistant helps you with the SIP configuration. After completing all the steps in the setup assistant, the product is ready to perform basic VoIP actions, such as receiving a call. Each time you finish the SIP setup assistant, new action rules and DTMF rules will be created.

Port Settings

- **SIP port** – Enter the port used for SIP sessions. The signalling traffic through this port will be non-encrypted. The default port number is 5060.
- **SIP TLS port** – Enter the port used for SIPS sessions and TLS-secured SIP sessions. The signalling traffic through this port will be encrypted using Transport Layer Security (TLS). The default port number is 5061.
- **RTP start port** – Enter the port used for the first RTP media stream in a SIP call. The default start port for media transport is 4000. Some firewalls might block RTP traffic on certain port numbers. A port number must be between 1024 and 65535.

Note

If the PBX changes the port used for SIP messages, it is possible to receive a notification regarding this. Go to **VoIP > Account Settings** and click **Modify**. Select the **Network**-tab and select **Allow port update messages through MWI**.

Network Address Translation (NAT) Traversal (port forwarding)

Use NAT traversal when the Axis product is connected to the network behind a NAT router or firewall device.

Without SIP-specific port forwarding, users of clients within the same private network would be able to talk to each other but users of clients in different networks would not.

The following NAT traversal settings are available:

- **STUN** – Session Traversal Utilities for NAT (STUN).
- **TURN** – Traversal Using Relays around NAT (TURN).
- **ICE** – Interactive Connectivity Establishment (ICE).

Each NAT traversal protocol can be used separately or in different combinations depending on the network environment.

Note

For more information about the product's general NAT traversal settings, see *NAT traversal (port mapping) for IPv4 on page 30*.

Interactive Connectivity Establishment (ICE)

Interactive Connectivity Establishment (ICE) enables the product to send a request that includes multiple addresses to the receiving device. In its response, the receiving device also includes multiple addresses. Through a process of connectivity checks, also called handshakes, the channel for communication is established.

ICE increases the chances of finding the most efficient path to successful communication between peer devices. If you also enable STUN and TURN, you improve the ICE protocol's chances of finding the most efficient path to successful communication.

AXIS C8033 Network Audio Bridge

Voice over IP (VoIP)

Session Traversal Utilities for NAT (STUN)

Session Traversal Utilities for NAT (STUN) is a client-server network protocol that enables the product to ask a STUN server on the Internet for a mapped public IP address. The STUN server response includes this IP address and port so that the client can use them in its SIP messages to other hosts and clients.

Like TURN, STUN can be used in full-cone, address-restricted cone, and port-restricted cone NAT setups. STUN is fast because it is lightweight. However, STUN does not allow incoming messages from symmetric NATs, and it cannot communicate with a peer behind the same NAT device.

Traversal Using Relays around NAT (TURN)

Traversal Using Relays around NAT (TURN) is a client-server network protocol that enables the product to ask a TURN server for a relayed IP address. The TURN server responds with its IP address and port so that the client can use them in its SIP messages.

TURN is primarily used in symmetric NAT setups. Like STUN, TURN can also be used in full-cone, address-restricted cone, and port-restricted cone NAT setups. But because the IP address and port provided by the TURN server are those of the TURN server itself, it works like a relay that forwards information to and from the client. This means that while TURN servers are reliable, they sometimes cause a bit of latency.

The Account Settings Page





The Account Settings page allows you to set up and manage SIP accounts. See *Create or Edit Accounts on page 15*. The SIP accounts can be verified by using *Test SIP Call*. See *Make Test Calls on page 17*.

The Account Settings page also includes an account list that shows an overview of the SIP account settings, including:

- Name. See also *Account Information on page 16*.
- SIP address. See also *About SIP Addresses on page 18*.
- Transport mode. See also *Transport Settings on page 17*.
- Default. See also *Account Information on page 16*.
- Registration status. See *Registration Status on page 15*.

Registration Status

The account status is indicated with dots in different colors. For more detailed information about an account's status, hover the mouse pointer over the status dot or select the account in the account list and click **Modify**.

-  SIP disabled – SIP is disabled.
Account not registered – The SIP account is not registered with a PBX, or the SIP account is a peer-to-peer account which does not register itself.
-  Provisional – The product is trying to register the account.
Redirection – The account or address needs to be redirected.
-  Successful – The account has successfully registered with the SIP registrar.
-  Failure – There is a problem with the account, such as the account credentials are wrong.

Create or Edit Accounts

To set up a SIP account:

1. Go to **Setup > VoIP > Account Settings**.
2. Click **Add**.

AXIS C8033 Network Audio Bridge

Voice over IP (VoIP)

3. Enter the account details.

Under the **General** tab:

- See *Account Information* on page 16.
- See *Account Credentials* on page 16.
- See *SIP Server Settings* on page 16.

Under the **Network** tab:

- See *Transport Settings* on page 17.
- See *Proxy Settings* on page 17.

4. Click **OK**.

To edit an account, select the account in the account list and click **Modify**.

To remove an account, select the account in the account list and click **Remove**.

Account Information

- **Name** – Enter a descriptive name. This can for example be a first and last name, a role, or a location. The name is used as an alias and is especially useful when several accounts have the same user ID.
- **Default account** – Select to make this the default account. Only one account can be the default account.

At startup, the first time the product is accessed or after a reset, a peer account is created automatically and set to be the default account. This peer account can only be removed if at least one more account has been added to the list.

The default account will be used when making a VAPIX® Application Programming Interface (API) call without specifying which SIP account to call from. For more information, visit www.axis.com/developer.

Account Credentials

- **User ID** – User ID is typically the extension or phone number assigned to the Axis product at the SIP server. It is also possible to use a SIP URI as a User ID if required by the SIP server.
- **Authentication ID** – Enter the Authenticaion ID used for authenticating against the SIP server. This is typically the same as the User ID.
- **Password** – Enter the password associated with the SIP account for authenticating against the SIP server.
- **Caller ID** – The name that is presented to the recipient of calls from this Axis product.

To create an account that is registered with a PBX or a service provider, enter the user ID, password, and the registrar address or domain name. See SIP Server Settings below. If you only enter a user ID, the account will be used as a peer-to-peer account.

Note

Unless the devices are connected to NATs with SIP-specific port forwarding such as STUN or TURN, the account will only be able to communicate with devices that are connected to the same private network. For more information, see *Network Address Translation (NAT) Traversal (port forwarding)* on page 14.

SIP Server Settings

- **Domain name** – If available, enter the public domain name. The domain name will be shown as part of the SIP address when calling other accounts. For more information, see *About SIP Addresses* on page 18.
- **Registrar address** – Enter the SIP server's registrar address. This is to point out the SIP registrar with which the account should register itself. The SIP registrar is the part of the PBX that keeps track of all the extensions.

AXIS C8033 Network Audio Bridge

Voice over IP (VoIP)

- **Secondary SIP Server** – The Axis product will try to register on the secondary SIP server if registration on the primary SIP server fails.

Transport Settings

- **Enable SIPS** – Select to use Secure Session Initiation Protocol (SIPS). SIPS uses the TLS transport mode to encrypt traffic. If you enable SIPS, you cannot select any other transport mode than TLS.
- **Transport mode** – Select the SIP transport mode for the account: UDP, TCP, or TLS. By default, TLS is used when media encryption is activated.
- **Media encryption** – Encrypts media (audio and video) in SIP calls.
 - **SRTP Best Effort** – Supports both encrypted and unencrypted media. Encryption is always used if available. Supported crypto suites are AES_CM_128_HMAC_SHA1_80 and AES_CM_128_HMAC_SHA1_32.
 - **SRTP Mandatory** – Supports only encrypted media, that is, SIP calls are only set up if the remote party offers SRTP media encryption. Supported crypto suites are AES_CM_128_HMAC_SHA1_80 and AES_CM_128_HMAC_SHA1_32.

Note

If more than one TLS peer-to-peer account is created and they are using different media encryption, the strictest value is applied to all of them. Registered accounts are not affected.

- **Allow port update messages through MWI** – Message waiting indicator (MWI) notifies the user of changes in the port settings.

The difference between SIPS (**Enable SIPS**) and SIP over TLS (**Transport mode – TLS**) is that SIPS ensures that each message transfer is encrypted, while TLS only ensures encryption of the SIP traffic to the next node in the network.

SIP over UDP Transport mode – UDP is generally faster as the message will be sent without the handshakes that SIPS, SIP over TLS, and **SIP over TCP Transport mode – TCP** offer.

Proxy Settings

A SIP proxy manages registration and routing requests from calling devices. The SIP proxy communicates with the private branch exchange (PBX) in order to find a route that a call has to take to reach a device that is set in a different location or site.

Address – Enter the SIP proxy server's address.

Username – Enter a user name for the SIP proxy server if required.

Password – Enter a password for the SIP proxy server if required.

Make Test Calls

To make sure that calls can be made from the Axis product, you can make a test call:

1. Go to **VoIP > Account Settings**.
2. From the list on the Account Settings page, select the account to make the test call from.
3. In the test call field, enter a valid SIP address to the other device. Use the format `sip:<extension>@<domain>` or `sips:<extension>@<domain>`. For more information and examples, see *About SIP Addresses on page 18*.
4. Click **Test call**. For more information, see *Transport Settings on page 17*.

The call status is displayed. For more information, see *Call Status on page 18*.
5. To end the call, click **End call**.

AXIS C8033 Network Audio Bridge

Voice over IP (VoIP)

About SIP Addresses

SIP addresses are used to identify users within a network just like you would use a phone number or an email address to contact a friend or colleague.

Like email addresses, SIP addresses are a type of uniform resource identifier (URI) that include two user-specific parts, a user ID or extension and a domain or IP address. Together with a prefix and the @ symbol, they make up a unique address. For example, if Caesar of ancient Rome had both an email address and a SIP address, they would be `mailto:caesar@ancientrome.it` and `sip:caesar@ancientrome.it` respectively. For local peer-to-peer calls only the IP address is required. For more examples and descriptions, see below.

SIP addresses are also known as SIP URIs or, in some cases, SIP numbers. For more information, see the PBX's and service provider's instructions.

Example

```
sip:192.168.0.90
sip:3468@172.25.33.142
sip:3468@voipprovider.com
```

Description

<code>sip:</code>	Prefix that tells the system that a SIP session is being started.
<code>sips:</code>	Prefix that tells the system that a SIPS session is being started.
<code><extension></code>	The user ID or extension of the recipient of the call. Or, if it is a peer-to-peer call, the IP address of the receiving device.
<code>@<domain></code>	The domain name or registrar address (IPv4 address) of the receiving device.

Important





The Axis product's VoIP functionality does not include support for IPv6.

For more information about SIP, SIPS, and TLS, see *Port Settings on page 14* and *Transport Settings on page 17*.

For more information about registrar addresses and domains, see *Account Credentials on page 16*.

Call Status

The call status is indicated with dots in different colors. More information about the call status is shown next to the status dot.

-  **Idle** – No active calls.
-  **Terminated** – The call was denied or ended, there was no answer, or the connection failed.
-  **Calling** – Calling and waiting for an answer.
-  **Active** – The call has been answered and is ongoing.

AXIS C8033 Network Audio Bridge

About applications

About applications

AXIS Camera Application Platform (ACAP) is an open platform that enables third parties to develop analytics and other applications for Axis products. To find out more about available applications, downloads, trials and licenses, go to axis.com/applications

To find the user manuals for Axis applications, go to axis.com

Note

- It is recommended to run one application at a time.

About application licenses

Some applications need a license to run. Licenses can be installed in two ways:

- Automatic installation – requires access to the Internet
- Manual installation – obtain the license key from the application vendor and upload the key to the Axis product

To request a license, the Axis product serial number (S/N) is required. The serial number can be found on the product label and under **System Options > Support > System Overview**.

How to upload and start an application

To upload and start an application:

1. Under **Upload Application**, click **Browse**. Locate the application file and click **Upload Package**.
2. Install the license (if applicable). For instructions, see the documentation provided by the application vendor.
3. Start the application. Go to **Applications**, select the application in the list of installed applications and click **Start**.
4. Configure the application. For instructions, see the documentation provided by the application vendor.

Note

- Applications can be uploaded by product administrators.
- Applications and licenses can be installed on multiple products at the same time using AXIS Camera Management, version 3.10 and later.

To generate a log file for the application, go to **Applications**. Select the application and click **Log**.

Application Considerations

If an application is upgraded, application settings, including the license, will be removed. The license must be reinstalled and the application reconfigured.

If the Axis product's firmware is upgraded, uploaded applications and their settings will remain unchanged, although this is not guaranteed by Axis Communications. Note that the application must be supported by the new firmware. For information about firmware upgrades, see *How to upgrade the firmware on page 35*.

If the Axis product is restarted, running applications will restart automatically.

If the Axis product is restored or reset to factory default, uploaded applications and their settings are removed. For information about restoring the Axis product, see *Maintenance on page 33*. For information about factory default, see *How to reset to factory default settings on page 34*.

AXIS C8033 Network Audio Bridge

About applications

AXIS Audio Player

The application AXIS Audio Player is included in this product. Use AXIS Audio Player to add, manage and schedule music playlists, streams and prerecorded announcements.

How to add music and announcements in the library

Drag and drop or browse to add music in the library. The audio files will be stored on a SD card.

You can either play directly from the library or create playlists.

How to create playlists in AXIS Audio Player

1. Click on the plus sign next to **Playlists** to add a new playlist.
2. Enter a name and click **Save**.

You can now drag and drop music files and announcements from the library to your playlist.

NOTICE

When deleting a file from the playlist it will still be in the library, but if you delete a file in the library it will be deleted both in the library and the playlist.



How to add streams to AXIS Audio Player

1. Click on the plus sign next to **Streams**.
2. Write the name of the stream and the URL to your MP3 stream.
3. Click **Save**.

How to create a schedule in AXIS Audio Player

1. Go to the **Schedule** tab.
2. Click and drag to create a box over the time slot you want to play a playlist or stream. The time and date settings on the local device are used for all scheduled activities.
3. In **New Event**:
 - Choose to play either directly from the library or to play a playlist or stream.
 - Click on the time for start or end if you want to change the time.
4. Click **Save**.

How to schedule announcements

1. Go to the **Schedule** tab.
2. Click .
3. Choose which announcement to play and the time to play it.
4. The announcement will be marked in the schedule with .

AXIS C8033 Network Audio Bridge

About events

About events

The event pages allow you to configure the product to perform actions when different events occur. For example, the product can play an audio clip according to a schedule or when a call is received. The set of conditions that defines how and when the action is triggered is called an action rule.

How to set up action rules

An action rule defines the conditions that must be met for the product to perform an action, for example play an audio clip or send a notification message. If multiple conditions are defined, all of them must be met to trigger the action.

For more information about available triggers and actions, see *About triggers on page 21* and *About actions on page 22*.

The following example describes how to set up an action rule to play an audio file when the Axis product receives an input signal from a video management system.

1. Go to **Events > Action Rules** and click **Add**.
2. Select **Enable** rule and enter a descriptive name for the rule.
3. Select **Input Signal** from the **Trigger** drop-down list.
4. Select **Virtual Inputs** from the second drop-down list.
5. Select **1** from the third drop-down list.
6. Select **Yes** in the **Active** list.
7. Optionally, select a **Schedule** and **Additional conditions**. See below.
8. Under **Actions**, select **Play Audio Clip** from the **Type** drop-down list.
9. Select the desired audio file from the **Play** drop-down list.
10. Click **OK**.

To use more than one trigger for the action rule, select **Additional conditions** and click **Add** to add additional triggers. When using additional conditions, all conditions must be met to trigger the action.

To prevent an action from being triggered repeatedly, a **Wait at least** time can be set. Enter the time in hours, minutes and seconds, during which the trigger should be ignored before the action rule can be activated again.

For more information, see the online help .

About triggers

Available action rule **triggers** and **conditions** include:

- **Applications** – Use installed applications to trigger the rule. See *About applications on page 19*.
- **Detectors**
- **Call**
 - **State** – Triggers an action rule when a call service state changes to active, calling, idle or ringing. This trigger can, for example, be used to play a dial tone when a call is connecting.
 - **State Change** – Triggers an action rule when a call state changes. This trigger can for example, be used to play a busy tone when a call is busy.
- **Hardware**

AXIS C8033 Network Audio Bridge

About events

- **Network** – Triggers an action rule when the network connection is lost. Select **Yes** to trigger the action rule when the network connection is lost. Select **No** to trigger the action rule when the network connection is restored.
- **Input Signal**
 - **Digital Input Port** – Triggers an action rule when an I/O port receives a signal from a connected device. See .
 - **Manual Trigger** – Triggers the action rule when the manual trigger is activated.
 - **Virtual Inputs** – Triggers an action rule when one of the virtual inputs changes states. It can be used by a client such as an access management system, through the VAPIX® application programming interface, to trigger actions. Virtual inputs can, for example, be connected to buttons in the management system's user interface.
- **System**
 - **System Ready** – Triggers an action rule when the system is in state ready. For example, the Axis product can detect the system state and send a notification when the system has started.

Select **Yes** to trigger the action rule when the product is in state ready. Note that the rule will only trigger when all necessary services, such as the event system, has started.
- **Time**
 - **Recurrence** – Triggers an action rule by monitoring the recurrences that you have created. You can use this trigger to initiate recurring actions such as sending notifications every hour. Select a recurrence pattern or create a new one. For more information about setting up a recurrence pattern, see *How to set up recurrences on page 24*.
 - **Use Schedule** – Triggers an action rule according to the selected schedule. See *How to create schedules on page 23*.

About actions

You can configure several actions:

- **Make Call** – Make a call to a specified SIP or Video Management System (VMS) recipient.
- **Answer Call** – Answer an incoming call.
- **Output Port** – Activate an I/O port to control an external device.
- **Play Audio Clip** – Play an audio clip when the action rule is triggered. From the **Play** drop-down list, select an audio clip to play when the action rule is triggered. To add new audio clips go to **Audio > Audio Clips**.
- **Send Notification** – Send a notification message to a recipient.
- **Send SNMP Trap** – Send an SNMP trap message to the operator. Make sure that SNMP is enabled and configured under **System Options > Network > SNMP**.
- **Status LED** – The status LED can be set to flash for the duration of the action rule or for a set number of seconds. The status LED can be used during installation and configuration to visually validate if the trigger settings work correctly. To set the status LED flash color, select a **LED Color** from the drop-down list.
- **Stop Audio Clip** – Stop playing a recorded audio clip when the Action rule is triggered.

How to add recipients

The product can send messages to notify recipients about events and alarms. But before the product can send notification messages, you must define one or more recipients. For information about available options, see *About recipient types on page 23*.

To add a recipient:

1. Go to **Events > Recipients** and click **Add**.

AXIS C8033 Network Audio Bridge

About events

2. Enter a descriptive name.
3. Select a recipient **Type**.
4. Enter the information needed for the recipient type.
5. Click **Test** to test the connection to the recipient.
6. Click **OK**.

About recipient types

The following recipient types are available:

- HTTP
- HTTPS
- Email
- TCP
- SIP

How to set up email recipients

Email recipients can be configured by selecting one of the listed email providers, or by specifying the SMTP server, port and authentication used by, for example, a corporate email server.

Note

Some email providers have security filters that prevent users from receiving or viewing large attachments, from receiving scheduled emails and similar. Check the email provider's security policy to avoid delivery problems and locked email accounts.

To set up an email recipient using one of the listed providers:

1. Go to **Events > Recipients** and click **Add**.
2. Enter a **Name** and select **Email** from the **Type** list.
3. Enter the email addresses to send emails to in the **To** field. Use commas to separate multiple addresses.
4. Select the email provider from the **Provider** list.
5. Enter the user ID and password for the email account.
6. Click **Test** to send a test email.

To set up an email recipient using for example a corporate email server, follow the instructions above but select **User defined as Provider**. Enter the email address to appear as sender in the **From** field. Select **Advanced settings** and specify the SMTP server address, port and authentication method. Optionally, select **Use encryption** to send emails over an encrypted connection. The server certificate can be validated using the certificates available in the Axis product. For information on how to upload certificates, see *About certificates on page 27*.

How to create schedules

To create a new schedule:

To use the schedule in an action rule, select the schedule from the **Schedule** drop-down list in the Action Rule Setup page.

AXIS C8033 Network Audio Bridge

About events

How to set up recurrences

Recurrences are used to trigger action rules repeatedly, for example every 5 minutes or every hour.

To set up a recurrence:

1. Go to **Events > Recurrences** and click **Add**.
2. Enter a descriptive name and recurrence pattern.
3. Click **OK**.

To use the recurrence in an action rule, first select **Time** from the **Trigger** drop-down list in the Action Rule Setup page and then select the recurrence from the second drop-down list.

To modify or remove recurrences, select the recurrence in the **Recurrences List** and click **Modify** or **Remove**.

AXIS C8033 Network Audio Bridge

About languages

About languages

Multiple languages can be installed in the Axis product. All web pages including the online help will be displayed in the selected language. To switch languages, go to **Setup > Languages** and first upload the new language file. Browse and locate the file and click the **Upload Language** button. Select the new language from the list and click **Save**.

Note

- Resetting the product to factory default settings will erase any uploaded language files and reset the product language to English.
- Clicking the **Restore** button on the Maintenance page will not affect the language.
- A firmware upgrade will not affect the language used. However if you have uploaded a new language to the product and later upgrade the firmware, it may happen that the translation no longer matches the product's web pages. In this case, upload an updated language file.
- A language already installed in the product will be replaced when a current or a later version of the language file is uploaded.

AXIS C8033 Network Audio Bridge

About system options

About system options

Security

Users

The user list displays authorized users and user groups (access levels):

- **Administrators** have unrestricted access to all settings. The administrator can add, modify and remove other users.

Note

Note that when the option **Encrypted & unencrypted** is selected, the webserver will encrypt the password. This is the default option for a new unit or a unit reset to factory default settings.

Under **HTTP/RTSP Password Settings**, select the type of password to allow. You may need to allow unencrypted passwords if there are viewing clients that do not support encryption, or if you upgraded the firmware and existing clients support encryption but need to log in again and be configured to use this functionality.

Deselect the **Enable Basic Setup** option to hide the Basic Setup menu. Basic Setup provides quick access to settings that should be made before using the Axis product.

IP Address Filter

IP address filtering is enabled on the page. Once enabled, the listed IP address are allowed or denied access to the Axis product. Select **Allow** or **Deny** from the list and click **Apply** to enable IP address filtering.

The administrator can add up to 256 IP address entries to the list (a single entry can contain multiple IP addresses).

HTTPS

HTTPS (HyperText Transfer Protocol over Secure Socket Layer, or HTTP over SSL) is a web protocol providing encrypted browsing. HTTPS can also be used by users and clients to verify that the correct device is being accessed. The security level provided by HTTPS is considered adequate for most commercial exchanges.

To use HTTPS, an HTTPS certificate must first be installed. Go to **System Options > Security > Certificates** to install and manage certificates. See *About certificates on page 27*.

To enable HTTPS on the Axis product:

1. Go to **System Options > Security > HTTPS**
2. Select an HTTPS certificate from the list of installed certificates.
3. Optionally, click **Ciphers** and select the encryption algorithms to use for SSL.
4. Set the **HTTPS Connection Policy** for the different user groups.
5. Click **Save** to enable the settings.

To access the Axis product via the desired protocol, in the address field in a browser, enter `https://` for the HTTPS protocol and `http://` for the HTTP protocol.

The HTTPS port can be changed on the **System Options > Network > TCP/IP > Advanced** page.

IEEE 802.1X

IEEE 802.1X is a standard for port-based Network Admission Control providing secure authentication of wired and wireless network devices. IEEE 802.1X is based on EAP (Extensible Authentication Protocol).

AXIS C8033 Network Audio Bridge

About system options

To access a network protected by IEEE 802.1X, devices must be authenticated. The authentication is performed by an authentication server, typically a **RADIUS** server, examples of which are FreeRADIUS and Microsoft Internet Authentication Service.

In Axis implementation, the Axis product and the authentication server identify themselves with digital certificates using EAP-TLS (Extensible Authentication Protocol – Transport Layer Security). The certificates are provided by a **Certification Authority (CA)**. You need:

- a CA certificate to authenticate the authentication server.
- a CA-signed client certificate to authenticate the Axis product.

To create and install certificates, go to **System Options > Security > Certificates**. See *About certificates on page 27*.

To allow the product to access a network protected by IEEE 802.1X:

1. Go to **System Options > Security > IEEE 802.1X**.
2. Select a **CA Certificate** and a **Client Certificate** from the lists of installed certificates.
3. Under **Settings**, select the EAPOL version and provide the EAP identity associated with the client certificate.
4. Check the box to enable IEEE 802.1X and click **Save**.

Note

For authentication to work properly, the date and time settings in the Axis product should be synchronized with an NTP server. See *Date & Time on page 27*.

About certificates

Note

- If the product is reset to factory default, all certificates, except preinstalled CA certificates, will be deleted.
- If the product is reset to factory default, all preinstalled CA certificates that have been deleted will be reinstalled.

How to create a self-signed certificate

1. Go to **Setup > System Options > Security > Certificates**.
2. Click **Create self-signed certificate** and provide the requested information.

How to create and install a CA-signed certificate

1. Create a self-signed certificate, see *How to create a self-signed certificate on page 27*.
2. Go to **Setup > System Options > Security > Certificates**.
3. Click **Create certificate signing request** and provide the requested information.
4. Copy the PEM-formatted request and send to the CA of your choice.
5. When the signed certificate is returned, click **Install certificate** and upload the certificate.

How to install additional CA certificates

1. Go to **Setup > System Options > Security > Certificates**.
2. Click **Install certificate** and upload the certificate.

Date & Time

The Axis product's date and time settings are configured under **System Options > Date & Time**.

AXIS C8033 Network Audio Bridge

About system options

To change the date and time settings, select the preferred **Time mode** under **New Server Time**:

- **Synchronize with computer time** – Sets date and time according to the computer's clock. With this option, date and time are set once and will not be updated automatically.
- **Synchronize with NTP Server** – Obtains date and time from an NTP server. With this option, date and time settings are updated continuously. For information on NTP settings, see *NTP Configuration on page 30*.
If using a host name for the NTP server, a DNS server must be configured. See *DNS Configuration on page 29*.
- **Set manually** – Allows you to manually set date and time.

If using an NTP server, select your **Time zone** from the drop-down list. If required, check **Automatically adjust for daylight saving time changes**.

Network

Basic TCP/IP Settings

IPv4 Address Configuration

By default, the Axis product is set to use IPv4 (IP version 4) and to obtain the IP address automatically via DHCP. The IPv4 settings are configured under **System Options > Network > TCP/IP > Basic**.

DHCP (Dynamic Host Configuration Protocol) allows network administrators to centrally manage and automate the assignment of IP addresses. DHCP should only be enabled if using dynamic IP address notification, or if the DHCP can update a DNS server. It is then possible to access the Axis product by name (host name).

If DHCP is enabled and the product cannot be accessed, run **AXIS IP Utility** to search the network for connected Axis products, or reset the product to the factory default settings (see *page 34*) and then perform the installation again.

To use a static IP address, check **Use the following IP address** and specify the IP address, subnet mask and default router.

IPv6 Address Configuration

If IPv6 (IP version 6) is enabled, the Axis product will receive an IP address according to the configuration in the network router.

To enable IPv6, go to **System Options > Network > TCP/IP > Basic**. Other settings for IPv6 should be configured in the network router.

ARP/Ping

The product's IP address can be assigned using ARP and Ping. For instructions, see *Assign IP Address Using ARP/Ping on page 28*.

The ARP/Ping service is enabled by default but is automatically disabled two minutes after the product is started, or as soon as an IP address is assigned. To re-assign IP address using ARP/Ping, the product must be restarted to enable ARP/Ping for an additional two minutes.

To disable the service, go to and clear the option **Enable ARP/Ping setting of IP address**.

Pinging the product is still possible when the service is disabled.

Assign IP Address Using ARP/Ping

The product's IP address can be assigned using ARP/Ping. The command must be issued within 2 minutes of connecting power.

1. Acquire a free static IP address on the same network segment as the computer.
2. Locate the serial number (S/N) on the product label.
3. Open a command prompt and enter the following commands:

AXIS C8033 Network Audio Bridge

About system options

Linux/Unix syntax

```
arp -s <IP address> <serial number> temp  
ping -s 408 <IP address>
```

Linux/Unix example

```
arp -s 192.168.0.125 00:40:8c:18:10:00 temp  
ping -s 408 192.168.0.125
```

Windows syntax (this may require that you run the command prompt as an administrator)

```
arp -s <IP address> <serial number>  
ping -l 408 -t <IP address>
```

Windows example (this may require that you run the command prompt as an administrator)

```
arp -s 192.168.0.125 00-40-8c-18-10-00  
ping -l 408 -t 192.168.0.125
```

4. Close the command prompt when the product responds with `Reply from 192.168.0.125:...` or similar.
5. Open a browser and type `http://<IP address>` in the Location/Address field.

Note

- To open a command prompt in Windows, open the **Start menu** and type `cmd` in the **Run/Search** field.
- To use the ARP command in Windows 8/Windows 7/Windows Vista, right-click the command prompt icon and select **Run as administrator**.
- To open a command prompt in Mac OS X, open the **Terminal utility** from **Application > Utilities**.

AXIS Video Hosting System (AVHS)

The AVHS settings are configured under **System Options > Network > TCP/IP > Basic**. The possibility to connect to an AVHS service is enabled by default. To disable, clear the **Enable AVHS** box.

Always – The Axis product will constantly attempt to connect to the AVHS service over the Internet. Once registered, the product will stay connected to the service. This option can be used when the product is already installed and it is not convenient or possible to use the one-click installation.

AXIS Internet Dynamic DNS Service

AXIS Internet Dynamic DNS Service assigns a host name for easy access to the product. For more information, see www.axiscam.net

To register the Axis product with AXIS Internet Dynamic DNS Service, go to **System Options > Network > TCP/IP > Basic**. Under **Services**, click the **AXIS Internet Dynamic DNS Service Settings** button (requires access to the Internet). The domain name currently registered at AXIS Internet Dynamic DNS service for the product can at any time be removed.

Note

AXIS Internet Dynamic DNS Service requires IPv4.

Advanced TCP/IP Settings

DNS Configuration

DNS (Domain Name Service) provides the translation of host names to IP addresses. The DNS settings are configured under **System Options > Network > TCP/IP > Advanced**.

Select **Obtain DNS server address via DHCP** to use the DNS settings provided by the DHCP server.

To make manual settings, select **Use the following DNS server address** and specify the following:

AXIS C8033 Network Audio Bridge

About system options

Domain name – Enter the domain(s) to search for the host name used by the Axis product. Multiple domains can be separated by semicolons. The host name is always the first part of a fully qualified domain name, for example, `myserver` is the host name in the fully qualified domain name `myserver.mycompany.com` where `mycompany.com` is the domain name.

Primary/Secondary DNS server – Enter the IP addresses of the primary and secondary DNS servers. The secondary DNS server is optional and will be used if the primary is unavailable.

NTP Configuration

NTP (Network Time Protocol) is used to synchronize the clock times of devices in a network. The NTP settings are configured under **System Options > Network > TCP/IP > Advanced**.

Select **Obtain NTP server address via DHCP** to use the NTP settings provided by the DHCP server.

To make manual settings, select **Use the following NTP server address** and enter the host name or IP address of the NTP server.

Host Name Configuration

The Axis product can be accessed using a host name instead of an IP address. The host name is usually the same as the assigned DNS name. The host name is configured under **System Options > Network > TCP/IP > Advanced**.

Select **Obtain host name via IPv4 DHCP** to use host name provided by the DHCP server running on IPv4.

Select **Use the host name** to set the host name manually.

Select **Enable dynamic DNS updates** to dynamically update local DNS servers whenever the Axis product's IP address changes.

For more information, see the online help .

Link-Local IPv4 Address

Link-Local Address is enabled by default and assigns the Axis product an additional IP address which can be used to access the product from other hosts on the same segment on the local network. The product can have a Link-Local IP and a static or DHCP-supplied IP address at the same time.

This function can be disabled under **System Options > Network > TCP/IP > Advanced**.

HTTP

The HTTP port used by the Axis product can be changed under **System Options > Network > TCP/IP > Advanced**. In addition to the default setting, which is 80, any port in the range 1024–65535 can be used.

HTTPS

NAT traversal (port mapping) for IPv4

A network router allows devices on a private network (LAN) to share a single connection to the Internet. This is done by forwarding network traffic from the private network to the "outside", that is, the Internet. Security on the private network (LAN) is increased since most routers are pre-configured to stop attempts to access the private network (LAN) from the public network (Internet).

Use **NAT traversal** when the Axis product is located on an intranet (LAN) and you wish to make it available from the other (WAN) side of a NAT router. With NAT traversal properly configured, all HTTP traffic to an external HTTP port in the NAT router is forwarded to the product.

NAT traversal is configured under **System Options > Network > TCP/IP > Advanced**.

Note

- For NAT traversal to work, this must be supported by the router. The router must also support UPnP®.
- In this context, router refers to any network routing device such as a NAT router, Network router, Internet Gateway, Broadband router, Broadband sharing device, or a software such as a firewall.

AXIS C8033 Network Audio Bridge

About system options

Enable/Disable – When enabled, the Axis product attempts to configure port mapping in a NAT router on your network, using UPnP. Note that UPnP must be enabled in the product (see).

Use manually selected NAT router – Select this option to manually select a NAT router and enter the IP address for the router in the field. If no router is specified, the product automatically searches for NAT routers on your network. If more than one router is found, the default router is selected.

Alternative HTTP port – Select this option to manually define an external HTTP port. Enter a port in the range 1024–65535. If the port field is empty or contains the default setting, which is 0, a port number is automatically selected when enabling NAT traversal.

Note

- An alternative HTTP port can be used or be active even if NAT traversal is disabled. This is useful if your NAT router does not support UPnP and you need to manually configure port forwarding in the NAT router.
- If you attempt to manually enter a port that is already in use, another available port is automatically selected.
- When the port is selected automatically it is displayed in this field. To change this, enter a new port number and click **Save**.

FTP

The FTP server running in the Axis product enables upload of new firmware, user applications, etc. The FTP server can be disabled under **System Options > Network > TCP/IP > Advanced**.

RTSP

The RTSP server running in the Axis product allows a connecting client to start an audio stream from the Axis product. The RTSP port number can be changed under **System Options > Network > TCP/IP > Advanced**. The default port is 554.

Note

Audio streams will not be available if the RTSP server is disabled.

SOCKS

SOCKS is a networking proxy protocol. The Axis product can be configured to use a SOCKS server to reach networks on the other side of a firewall or proxy server. This functionality is useful if the Axis product is located on a local network behind a firewall, and notifications, uploads, alarms, etc need to be sent to a destination outside the local network (for example the Internet).

SOCKS is configured under **System Options > Network > SOCKS**. For more information, see the online help .

QoS (Quality of Service)

QoS (Quality of Service) guarantees a certain level of a specified resource to selected traffic on a network. A QoS-aware network prioritizes network traffic and provides a greater network reliability by controlling the amount of bandwidth an application may use.

SNMP

The Simple Network Management Protocol (SNMP) allows remote management of network devices. An SNMP community is the group of devices and management station running SNMP. Community names are used to identify groups.

To enable and configure SNMP in the Axis product, go to the **System Options > Network > SNMP** page.

Depending on the level of security required, select the version on SNMP to use.

Traps are used by the Axis product to send messages to a management system on important events and status changes. Check **Enable traps** and enter the IP address where the trap message should be sent and the **Trap community** that should receive the message.

Note

If HTTPS is enabled, SNMP v1 and SNMP v2c should be disabled.

AXIS C8033 Network Audio Bridge

About system options

Traps for SNMP v1/v2 are used by the Axis product to send messages to a management system on important events and status changes. Check **Enable traps** and enter the IP address where the trap message should be sent and the **Trap community** that should receive the message.

The following traps are available:

- Cold start
- Warm start
- Link up
- Authentication failed

SNMP v3 provides encryption and secure passwords. To use traps with SNMP v3, an SNMP v3 management application is required.

To use SNMP v3, HTTPS must be enabled, see *HTTPS on page 26*. To enable SNMP v3, check the box and provide the initial user password.

Note

The initial password can only be set once. If the password is lost, the Axis product must be reset to factory default, see *How to reset to factory default settings on page 34*.

UPnP

The Axis product includes support for UPnP®. UPnP is enabled by default and the product is automatically detected by operating systems and clients that support this protocol.

UPnP can be disabled under **System Options > Network > UPnP**.

Bonjour

The Axis product includes support for Bonjour. Bonjour is enabled by default and the product is automatically detected by operating systems and clients that support this protocol.

Bonjour can be disabled under **System Options > Network > Bonjour**.

Storage

You can record and store your videos either on a network storage, such as a NAS (network-attached storage) or on an onboard storage.

Ports & Devices

I/O Ports

The Axis product provides two configurable input and output ports for connection of external devices.

To configure the I/O ports, go to **System Options > Ports & Devices > I/O Ports**. Each port can function as input or output:

- Input as Open circuit – The input becomes active when the circuit is grounded by. It remains inactive as long as its normal state equals its current status.
- Input as Grounded circuit – The input becomes active when the circuit is opened.
- Output as Open circuit – The output port is in a non-conductive state when its current status is open circuit. The current status of an output port can be changed by, for example, an action rule.
- Output as Grounded circuit – The output port is in a conductive state when its current status is grounded circuit.

AXIS C8033 Network Audio Bridge

About system options

LED Settings

The Status LED can be configured to be unlit during normal operation. To configure, go to **Setup > System Options > Ports & Devices > LED**.

The available options for the Status Indicator LED are:

- **Normal:** The status LED shows steady green during normal operation. This is the default setting.
- **Off:** The status LED is off during normal operation. This can be useful in making the Axis product less noticeable.

Port Status

Maintenance

The Axis product provides several maintenance functions. These are available under **System Options > Maintenance**.

Click **Restart** to perform a correct restart if the Axis product is not behaving as expected. This will not affect any of the current settings.

Note

A restart clears all entries in the Server Report.

Click **Restore** to reset most settings to the factory default values. The following settings are not affected:

- the boot protocol (DHCP or static)
- the static IP address
- the default router
- the subnet mask
- the system time

Click **Default** to reset all settings, including the IP address, to the factory default values. This button should be used with caution. The Axis product can also be reset to factory default using the control button, see *How to reset to factory default settings on page 34*.

For information about firmware upgrade, see *How to upgrade the firmware on page 35*.

Support

Support Overview

The page provides information on troubleshooting and contact information, should you require technical assistance.

See also *Troubleshooting on page 35*.

System Overview

Logs & Reports

The page generates logs and reports useful for system analysis and troubleshooting. If contacting Axis Support, please provide a server report with your query.

System Log – Provides information about system events.

Access Log – Lists all failed attempts to access the product. The access log can also be configured to list all connections to the product (see below).

AXIS C8033 Network Audio Bridge

About system options

View Server Report – Provides information about the product status in a pop-up window. The access log is automatically included in the server report.

Download Server Report – Creates a .zip file that contains a complete server report text file in UTF-8 format. Select the **Include snapshot from Live View** option to include a snapshot of the product's Live View. The .zip file should always be included when contacting support.

Parameter List – Shows the product's parameters and their current settings. This may prove useful when troubleshooting or when contacting Axis Support.

Connection List – Lists all clients that are currently accessing media streams.

Crash Report – Generates an archive with debugging information. The report takes several minutes to generate.

Advanced

Scripting

Scripting allows experienced users to customize and use their own scripts.

NOTICE

Improper use may cause unexpected behavior and loss of contact with the Axis product.

Axis strongly recommends that you do not use this function unless you understand the consequences. Axis Support does not provide assistance for problems with customized scripts.

To open the Script Editor, go to **System Options > Advanced > Scripting**. If a script causes problems, reset the product to its factory default settings, see [page 34](#).

For more information, see www.axis.com/developer

Plain Config

Plain Config is for advanced users with experience of Axis product configuration. Most parameters can be set and modified from this page.

To open Plain Config, go to **System Options > Advanced > Plain Config**. Axis Support does not provide assistance with this feature.

How to reset to factory default settings

Important

Reset to factory default should be used with caution. A reset to factory default resets all settings, including the IP address, to the factory default values.

To reset the product to the factory default settings:

1. Disconnect power from the product.
2. Press and hold the control button while reconnecting power. See *Product overview*.
3. Keep the control button pressed for 10 seconds until the status LED indicator turns amber for the second time.
4. Release the control button. The process is complete when the status LED indicator turns green. The product has been reset to the factory default settings. If no DHCP server is available on the network, the default IP address is 192.168.0.90
5. Use the installation and management software tools, assign an IP address, set the password, and access the product.

AXIS C8033 Network Audio Bridge

Troubleshooting

Troubleshooting

How to check the current firmware

Firmware is software that determines the functionality of network devices. One of your first actions when troubleshooting a problem should be to check the current firmware version. The latest version may contain a correction that fixes your particular problem. The current firmware version in the Axis product is displayed in the page **Setup > Basic Setup** and in **Setup > About**.

How to upgrade the firmware

Important

- Your dealer reserves the right to charge for any repair attributable to faulty upgrade by the user.
- Preconfigured and customized settings are saved when the firmware is upgraded (providing the features are available in the new firmware) although this is not guaranteed by Axis Communications AB.

Note

- When you upgrade the Axis product with the latest firmware, the product receives the latest functionality available. Always read the upgrade instructions and release notes available with each new release before upgrading the firmware.

Symptoms, possible causes and remedial actions

Problems upgrading the firmware

Firmware upgrade failure	If the firmware upgrade fails, the product reloads the previous firmware. Check the firmware file and try again.
--------------------------	--

Problems setting the IP address

When using ARP/Ping

The product is located on a different subnet	If the IP address intended for the product and the IP address of the computer used to access the product are located on different subnets, you will not be able to set the IP address. Contact your network administrator to obtain an IP address.
--	--

The IP address is being used by another device	Disconnect the Axis product from the network. Run the Ping command (in a Command/DOS window, type <code>ping</code> and the IP address of the product): <ul style="list-style-type: none">• If you receive: <code>Reply from <IP address>: bytes=32; time=10...</code> this means that the IP address may already be in use by another device on the network. Obtain a new IP address from the network administrator and reinstall the product.• If you receive: <code>Request timed out</code>, this means that the IP address is available for use with the Axis product. Check all cabling and reinstall the product.
--	---

Possible IP address conflict with another device on the same subnet	The static IP address in the Axis product is used before the DHCP server sets a dynamic address. This means that if the same default static IP address is also used by another device, there may be problems accessing the product.
---	---

The product cannot be accessed from a browser

Cannot log in	When HTTPS is enabled, ensure that the correct protocol (HTTP or HTTPS) is used when attempting to log in. You may need to manually type <code>http</code> or <code>https</code> in the browser's address field.
---------------	--

If the password for the user `root` is lost, the product must be reset to the factory default settings. See *How to reset to factory default settings on page 34*.

The IP address has been changed by DHCP	
---	--

AXIS C8033 Network Audio Bridge

Troubleshooting

The product is accessible locally but not externally

Router configuration	To configure your router to allow incoming data traffic to the Axis product, enable the NAT-traversal feature which will attempt to automatically configure the router to allow access to the Axis product, see <i>NAT traversal (port mapping) for IPv4 on page 30</i> . The router must support UPnP®.
Firewall protection	Check the Internet firewall with your network administrator.
Default routers required	

AXIS C8033 Network Audio Bridge

Specifications

Specifications

To find the latest version of the product's datasheet, go to the product page on *axis.com* and locate **Support & Documentation**.

