

Before Reading the Operation Guide

Notice on New Functions and Changes

This notice describes new functions and specification change with the latest firmware, and the latest information such as changes to the "Operation Guide" on P. ii to P. xvii.

For those already using this product

For the latest information of the firmware update, please read P. ii to P. xvii.

For those using this product for the first time

Please read P. ii to P. xvii in conjunction with P. 1 and onwards of the "Operation Guide".

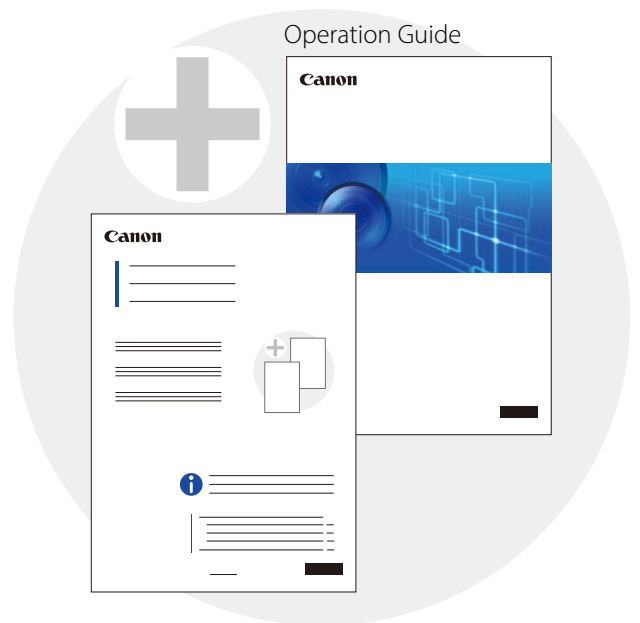

Updating to the latest firmware enables new functions and specification changes. For information on checking the firmware version and updating the firmware, see the next page.

"Before Reading the Operation Guide"	
Checking and Updating the Firmware Version	P. ii
New Functions and Specification Changes	P. iii
Information on Other Changes	P. xiii
"Operation Guide"	P. 1

Checking and Updating the Firmware Version

Use the Camera Management Tool to check and update the firmware version of the camera.
 Download the latest firmware from the Canon website and update the firmware of the camera, as required.
 For details on using the Camera Management Tool, please refer to "Camera Management Tool User Manual".

Latest Firmware Versions

Camera Model	Firmware Version
VB-H45, VB-H45B ^{*1} , VB-M44, VB-M44B ^{*1}	1.1.x
VB-H730F Mk II	
VB-S30D Mk II, VB-S31D Mk II	
VB-S800D Mk II, VB-S900F Mk II	
VB-S805D Mk II, VB-S905F Mk II	
VB-S30VE, VB-S800VE, VB-S910F	1.1.x
VB-R13VE (H2) ^{*2} , VB-R13VE, VB-R13, VB-R11VE (H2) ^{*2} , VB-R11VE, VB-R11	1.2.x
VB-R12VE (H2) ^{*2} , VB-R12VE, VB-R10VE (H2) ^{*2} , VB-R10VE	
VB-M50B	
VB-H652LVE, VB-H651VE, VB-H651V	
VB-M641VE, VB-M641V, VB-M640VE, VB-M640V	
VB-H761LVE (H2) ^{*2} , VB-H761LVE-H, VB-H761LVE, VB-H760VE (H2) ^{*2} , VB-H760VE	
VB-H751LE (H2) ^{*2} , VB-H751LE-H, VB-H751LE	
VB-M741LE (H2) ^{*2} , VB-M741LE-H, VB-M741LE, VB-M740E (H2) ^{*2} , VB-M740E	

*1 The difference between VB-H45 and VB-H45B, as well as VB-M44 and VB-M44B is the external color only.

*2 The only difference between VB-H761LVE (H2), VB-H760VE (H2), VB-H751LE (H2), VB-M741LE (H2), VB-M740E (H2), VB-R13VE (H2), VB-R12VE (H2), VB-R11VE (H2), VB-R10VE (H2) and VB-H761LVE, VB-H760VE, VB-H751LE, VB-M741LE, VB-M740E, VB-R13VE, VB-R12VE, VB-R11VE, VB-R10VE is with/without hydrophilic coating.

The "Operation Guide" is written for firmware versions earlier than those indicated in the above table.
 Please read the following pages for information on the new functions and specification changes of the latest firmware version.

New Functions and Specification Changes

Target Models

The new functions and specification changes of the new firmware are indicated below.

Screenshots on this notice may differ from the actual screens, depending on the model you are using.

●: Supported with the latest firmware ○: Already supported

New Functions and Specification Changes	Target Models			
	VB-H45, VB-M44 VB-H730F Mk II VB-S30D Mk II VB-S31D Mk II VB-S800D Mk II VB-S900F Mk II VB-S805D Mk II VB-S905F Mk II	VB-S30VE VB-S800VE VB-S910F	VB-R13VE (H2), VB-R13VE VB-R13, VB-R11VE (H2) VB-R11VE, VB-R11 VB-R12VE (H2), VB-R12VE VB-R10VE (H2), VB-R10VE VB-M50B, VB-H652LVE VB-H651VE, VB-H651V VB-M641VE, VB-M641V VB-M640VE, VB-M640V VB-H761LVE (H2) VB-H761LVE-H, VB-H761LVE VB-H760VE (H2), VB-H760VE VB-H751LE (H2) VB-H751LE-H, VB-H751LE VB-M741LE (H2) VB-M741LE-H, VB-M741LE VB-M740E (H2), VB-M740E	
Operating Environment: Updating the PC environment/mobile device information	●	●	●	P. v
Configuring Initial Camera Settings: Administrator account registration added	○	○	●*4	P. vi
Camera Viewer: [One-shot AF] button added*1	●	●	●	P. vii
Camera Viewer: Snapshot saving format changed	●	●	●	P. vii
Setting Page: Entering the confirmation password for the authorized user	○	●	●	P. viii
Setting Page: [Simple Camera Settings] recommended values changed and performance improved	○	○	●	P. viii
Setting Page: Preset selection added to the [ADSR] and [Privacy Mask] settings*2	○	●	○	P. ix
Setting Page: Number of input characters for [On-screen display] changed	○	●	○	P. x
Setting Page: Items added to [General Audio]*3	○	○	●	P. x

New Functions and Specification Changes	Target Models			
	VB-H45, VB-M44 VB-H730F Mk II VB-S30D Mk II VB-S31D Mk II VB-S800D Mk II VB-S900F Mk II VB-S805D Mk II VB-S905F Mk II	VB-S30VE VB-S800VE VB-S910F	VB-R13VE (H2), VB-R13VE VB-R13, VB-R11VE (H2) VB-R11VE, VB-R11 VB-R12VE (H2), VB-R12VE VB-R10VE (H2), VB-R10VE VB-M50B, VB-H652LVE VB-H651VE, VB-H651V VB-M641VE, VB-M641V VB-M640VE, VB-M640V VB-H761LVE (H2) VB-H761LVE-H, VB-H761LVE VB-H760VE (H2), VB-H760VE VB-H751LE (H2) VB-H751LE-H, VB-H751LE VB-M741LE (H2) VB-M741LE-H, VB-M741LE VB-M740E (H2), VB-M740E	
Setting Page: Changed the saving items when initializing	○	●	●	P. xi
Factory Default Settings: Setting values changed (IPv4, Administrator Account, Focus)	○	○	●*5	P. xii
Factory Default Settings: Setting values changed (DNS, Camera Name, Day/Night, Memory Card Operations)	○	●	●	P. xii
Factory Default Settings: Setting values changed (User Authority)	●	●	●	P. xii
Setting Name: Displaying of bit rate control	○	●	●	P. xii

*1 Only for models with the auto focus function

*2 Only for models with optical zoom

*3 Only for models with the audio transmission/reception function

*4 Only for VB-R11VE (H2), VB-R11VE, VB-R11, VB-R10VE (H2), VB-R10VE, VB-M641VE, VB-M641V, VB-M640VE, VB-M640V, VB-M741LE (H2), VB-M741LE-H, VB-M741LE, VB-M740E (H2), and VB-M740E

*5 IPv4, Administrator Account:

Only for VB-R11VE (H2), VB-R11VE, VB-R11, VB-R10VE (H2), VB-R10VE, VB-M641VE, VB-M641V, VB-M640VE, VB-M640V, VB-M741LE (H2), VB-M741LE-H, VB-M741LE, VB-M740E (H2), and VB-M740E

Focus:

Only for VB-H651VE, VB-H651V, VB-M641VE, VB-M641V, VB-M640VE, and VB-M640V

Operating Environment

The operating environment for the latest firmware is described below.

■ PC Environment Details

CPU (Recommended)	Intel Core i7-2600 or higher	
Graphics Board (Recommended)	Not specified	
Memory (Recommended)	2 GB or higher	
Viewer Display (Recommended)	1920 x 1080 or higher	
OS and Compatible Web Browser	Windows 7 Ultimate/Windows 7 Professional/Windows 7 Enterprise/Windows 7 Home Premium SP1 32/64-bit	Internet Explorer 11 32/64-bit, Chrome 65* ²
	Windows 8.1/Windows 8.1 Pro/Windows 8.1 Enterprise 32/64-bit* ¹	Internet Explorer 11 32/64-bit, Chrome 65* ²
	Windows 10 Pro/Windows 10 Enterprise/Windows 10 Education/Windows 10 Home 32/64-bit	Internet Explorer 11 32/64-bit, Microsoft Edge* ² , Chrome 65* ²
	Windows Server 2008 Standard SP2 32/64-bit	Internet Explorer 9 32-bit
	Windows Server 2008 R2 Standard SP1 64-bit	Internet Explorer 11 32/64-bit, Chrome 65* ²
	Windows Server 2012 Standard 64-bit* ¹	Internet Explorer 10 32/64-bit, Chrome 65* ²
	Windows Server 2012 R2 Standard 64-bit* ¹	Internet Explorer 11 32/64-bit, Chrome 65* ²
Windows Server 2016 Standard 64-bit	Internet Explorer 11 64-bit, Chrome 65* ²	
	<ul style="list-style-type: none"> – Must be configured to allow use of JavaScript, IFRAME (html tag), and web storage – For Camera Viewer only, cookies must be enabled 	
Operating System Language	Setting Page, Camera Viewer, Mobile Camera Viewer: German/English/Spanish/French/Italian/Polish/Russian/Turkish/Thai/Korean/ Chinese (Simplified) /Japanese	

*1 Cannot be started from the Windows start screen

*2 Does not support playback of Video (H.264) or audio transmission/reception

■ Verified Mobile Devices (Setting Page, Camera Viewer, Mobile Camera Viewer)

– As of April 2018

Mobile Devices	OS	Compatible Web Browser
Surface 3	Windows 10 Home 64-bit	Internet Explorer 11, Microsoft Edge* ¹
	<ul style="list-style-type: none"> – Must be configured to allow use of JavaScript, and web storage – For Camera Viewer only, cookies must be enabled 	
iPad Pro 12.9-inch iPad Pro 10.5-inch iPhone 7* ² iPhone 8 Plus* ² iPhone X* ²	iOS 10.3.3	Safari* ¹
	iOS 11.3	
<ul style="list-style-type: none"> – Must be configured to allow use of JavaScript, and web storage – For Camera Viewer only, cookies must be enabled 		
Nexus 9	Android 7.1.1	Chrome 65* ¹
Galaxy Tab S 8.4	Android 4.4.2	Chrome 65* ¹
Nexus 6P* ²	Android 8.1	Chrome 65* ¹
Galaxy S8* ²	Android 8.0	Chrome 65* ¹

*1 Does not support playback of Video (H.264) or audio transmission/reception

*2 Setting Page and Camera Viewer are not supported

Configuring Initial Camera Settings

The fields for [Administrator Account] are now blank as a default. When restoring the factory default settings after updating the firmware, it is necessary to set [Administrator Name] and [Password] to access the camera for the first time. This change has been made in firmware version 1.1.8 or later.

The default screen displayed when accessing from the web browser for the first time

When using the Camera Management Tool to configure the initial settings, see "Camera Management Tool User Manual".

■ Adjusting Video > Focusing

One-shot AF operations are now also possible in the Camera Viewer.

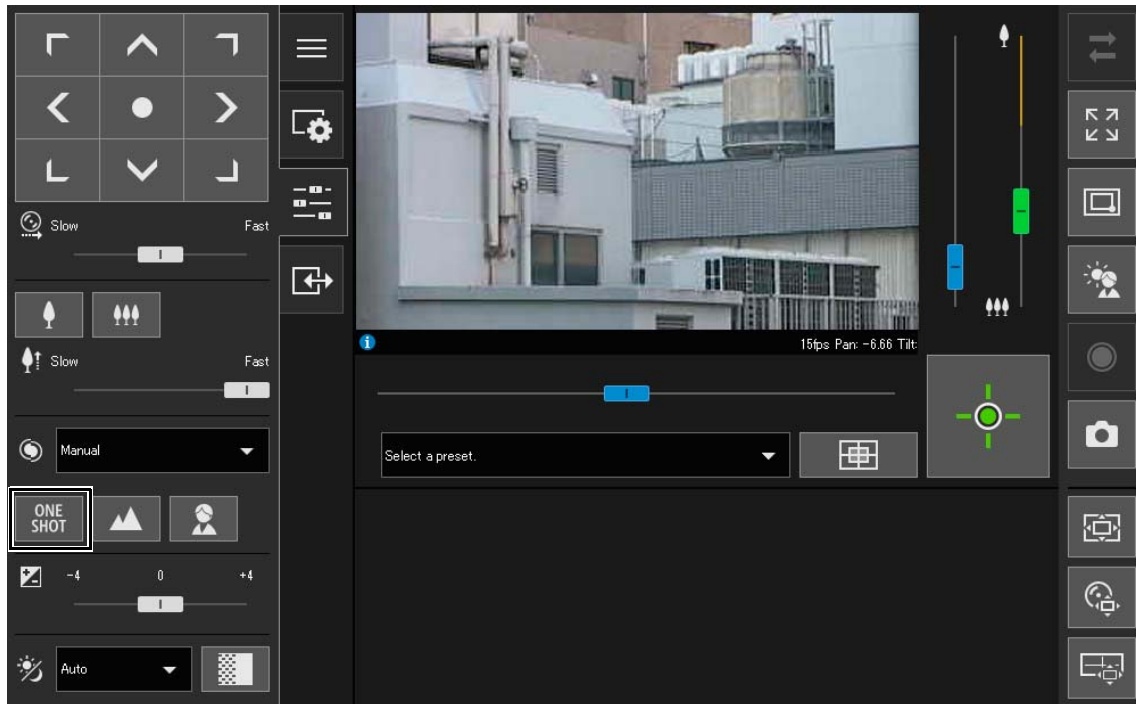

ONE SHOT [One-shot AF] button

Use when [Focus] is set to [Manual]. When you click **ONE SHOT**, the camera will focus once using autofocus and then switch to manual.

Important

For precautions on focusing and the focus range, please refer to "Operation Guide".

■ Saving Snapshots

The following "Note" has been changed.

Before Change

- The snapshot is saved as a JPEG file.

After Change

- The saving format of the snapshot depends on the web browser being used.

Setting Page

■ [Basic] > [User Management]

It is now necessary to enter a confirmation password when setting the password for an authorized user.

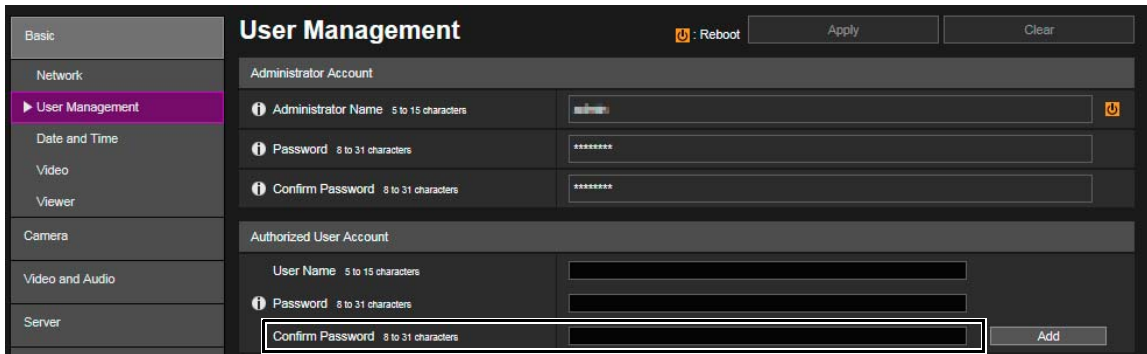

[Confirm Password]

Enter the same password as above for confirmation.

■ [Camera] > [Initial Settings]

Recommended values have been changed for [Exposure], [Shutter Speed Limit (Lower)], [Shutter Speed Limit (Upper)], and [Shutter Speed], which are displayed when [Motion Priority] in [Simple Camera Settings] is selected. The notes regarding [Motion Priority] and [Depth Priority] in [Simple Camera Settings] have been changed according to the improved performance.

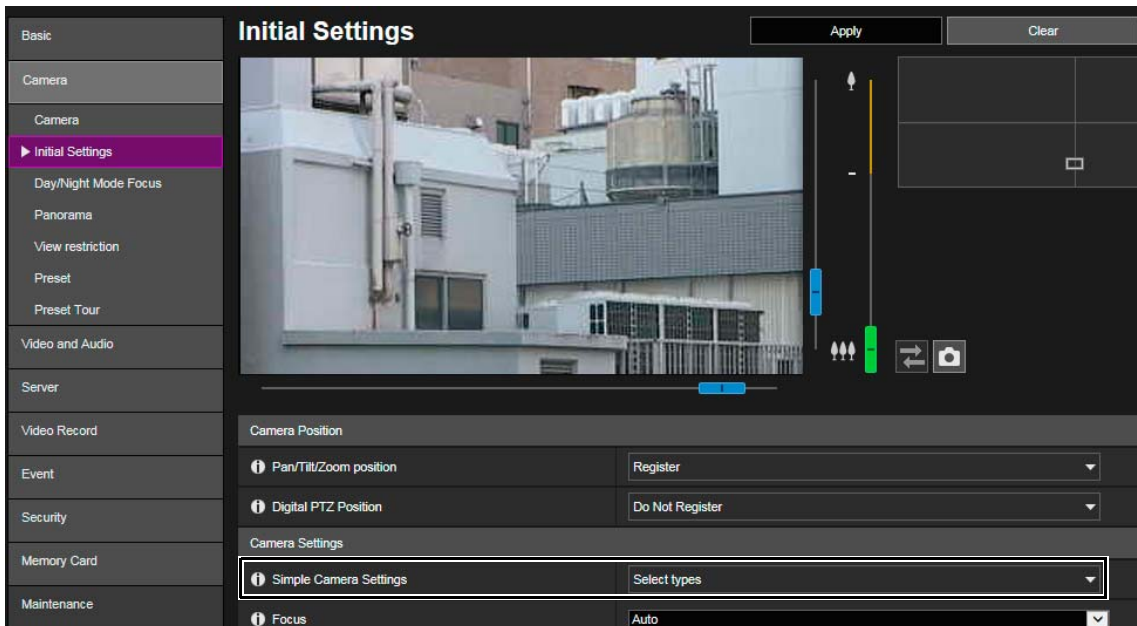

[Simple Camera Settings]

Type	Motion Priority
[Exposure]	Auto
[Shutter Speed Limit (Lower)]	1/1000 (sec.)
[Shutter Speed Limit (Upper)]	1/16000 (sec.)
[Shutter Speed]	-

Important

Note the following regarding [Simple Camera Settings].

[Motion Priority]

- Flickering may occur due to fluorescent lighting, etc.
- In low-light conditions, video may become comparatively darker than [Standard Settings], and noise may increase.

[Depth Priority]

- In low-light conditions, video may become comparatively darker than [Standard Settings], and noise may increase.

■ [Video and Audio] > [ADSR] / [Video and Audio] > [Privacy Mask]

When changing the camera angle in the settings for specifying the ADSR area and privacy mask area, presets can now be selected from a preset selection box in addition to slider operations.

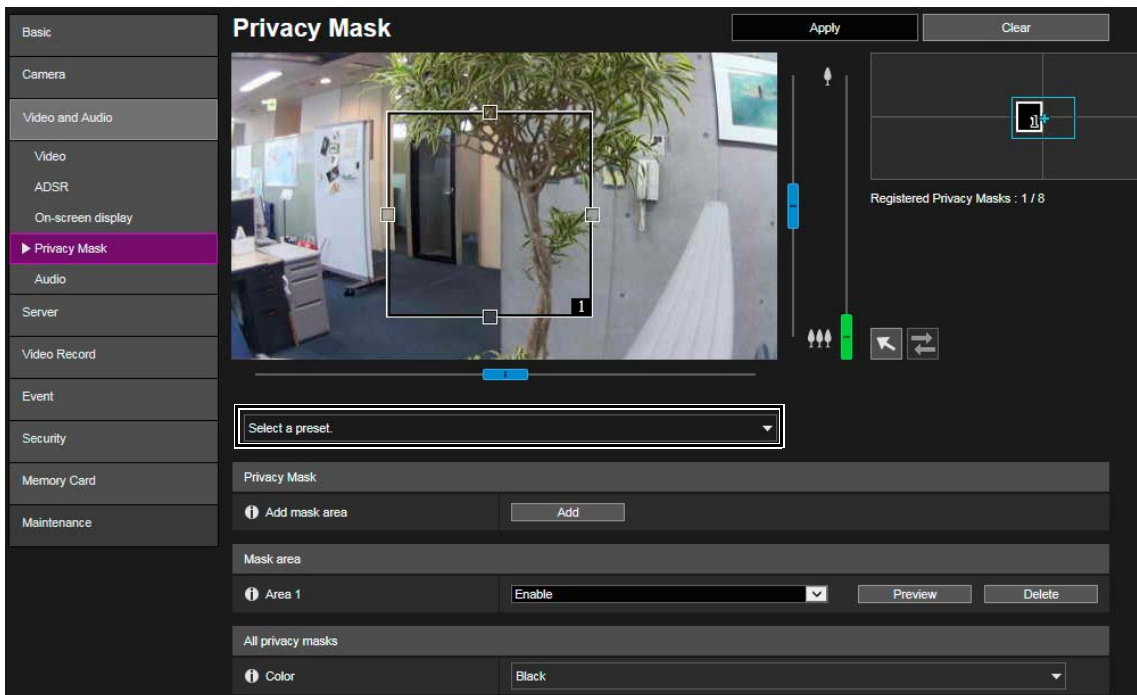

■ [Video and Audio] > [On-screen display]

The maximum number of characters that can be entered for [Text string display] has been increased to 40 when [Display designated string] is selected in [Text display].

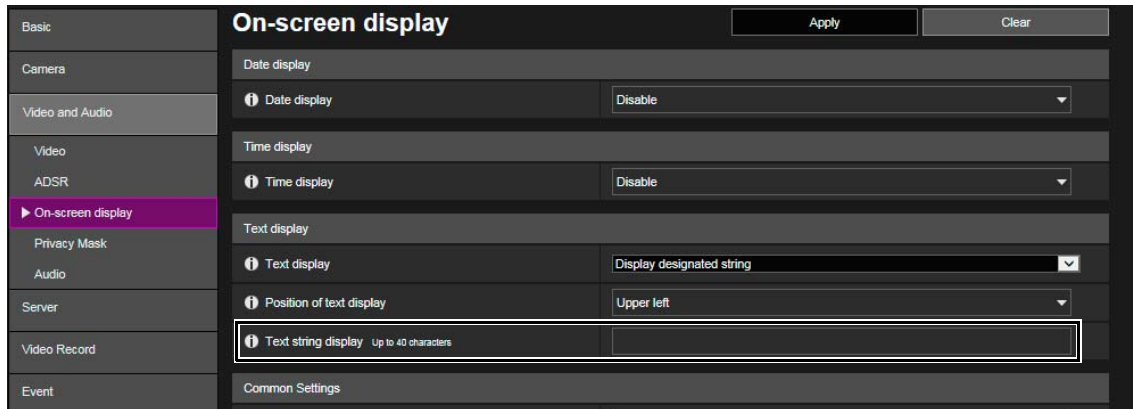

🗨️ Note

- Setting the [Text display], [Date display], and [Time display] to the same position may result in not displaying all of the information. In such case, items set with [Upper right] or [Lower right] for [Position of text display] are prioritized for display.
- All of the texts may not be displayed depending on the video size, text length, and text position. Check the display after changing the video size and on-screen display settings.

■ [Video and Audio] > [Audio]

Whether to use [Audio Input], and [Audio Communication Method] can now be selected. [Current Volume Level] can become displayed for audio input.

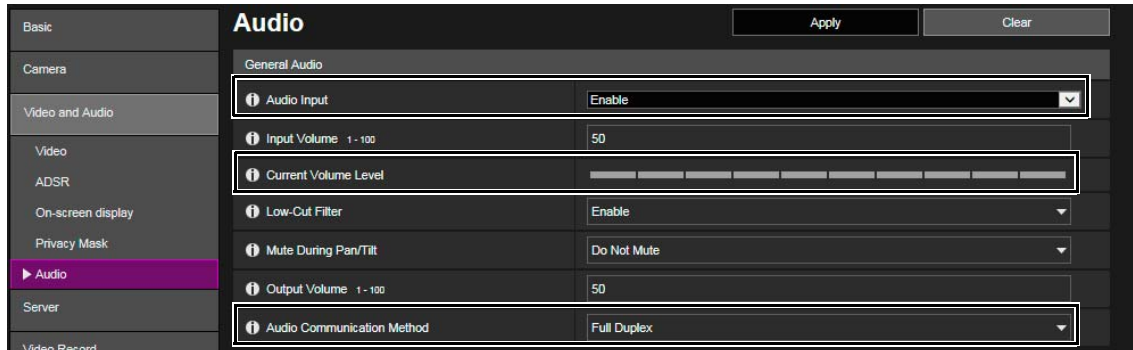

[Audio Input]

Select whether to use audio input from the microphone. If you select [Enable], you can use functions related to audio input such as [Audio Server] > [Audio Transmission from the Camera] or [Event] > [Audio Detection] > [Volume Detection Event].

If you select [Disable] and click [Apply], the following settings are locked and audio input functions are disabled.

- [Audio Server] > [Audio Transmission from the Camera] > [Disable]
- [Server] > [RTP Server] > [RTP Stream 1] - [RTP Stream 5] > [Audio Transmission] > [Disable]
- [Event] > [Audio Detection] > [Volume Detection] > [Volume Detection Event] > [Disable]
- [Event] > [Audio Detection] > [Scream Detection] > [Scream Detection Event] > [Disable]

[Current Volume Level]

When [Audio Input] is set to [Enable], the current volume level is displayed on the status bar.

[Audio Communication Method]

Select the audio transmission/reception method.

[Half Duplex]

You can prevent howling that occurs when the microphone and speaker are placed nearby. However, there is no sound sent from the camera to the viewer while the camera is receiving audio from the viewer or while an audio file is being played back. Therefore, even if the [Audio Reception] button of the viewer is active (purple), audio input from the microphone cannot be received.

[Full Duplex]

Audio can be transmitted from the camera to the viewer even while the camera is receiving audio from the viewer.

■ [Maintenance] > [General]

The underlined items are now saved when [Initialization] > [Network Settings] > [Save] is selected.

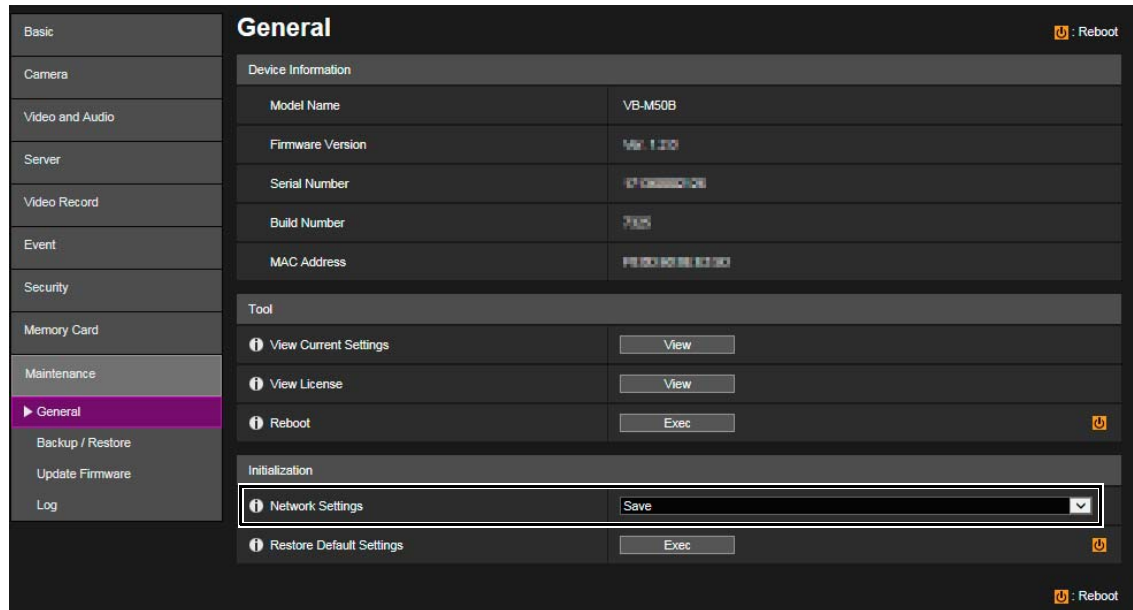

[Network Settings]

If you set this to [Save], the following settings are retained when initializing.

- Administrator Name
- Administrator Password
- Network Settings
- NTP Server
- HTTP Server
- Host Access Restrictions
- Time Zone
- Certificates
- Private Key
- IPsec

If you set this to [Do not save], the above settings are also initialized.

Since the administrator account is also initialized, you will become unable to connect to the camera. Use the Camera Management Tool to configure the initial settings.

■ [Maintenance] > [Update Firmware]

By selecting [Update Firmware] > [Restore Default Settings] > [Restore], the items saved have been updated to the same as the list above ([Initialization] > [Network Settings] > [Save]).

■ List of Factory Default Settings

The setting values for the factory default settings are changed as indicated below.

Item	Before Change	After Change
<ul style="list-style-type: none"> IPv4 IPv4 Address Settings Method 	Manual	Auto (DHCP)
<ul style="list-style-type: none"> DNS Set Name Server Address Automatically 	Disable	Use DHCP/DHCPv6
<ul style="list-style-type: none"> Administrator Account Administrator Name Password 	With setting values	Without setting values
<ul style="list-style-type: none"> User Authority Guest User Camera Control 	Video distribution and Camera control	No access privileges
<ul style="list-style-type: none"> User Authority Guest User Audio Distribution 	Yes	No
<ul style="list-style-type: none"> Camera Name Camera Name (alphanumeric characters) 	Camera	Model Name (Example) VB-M50B
<ul style="list-style-type: none"> Camera Settings Focus 	Manual	Auto
<ul style="list-style-type: none"> Camera Settings Day/Night 	Day Mode	Auto
<ul style="list-style-type: none"> Memory Card Operations Overwrite videos 	Disable	Enable



Note

Since cameras with the factory default settings are configured to obtain an IP address from the DHCP server, detect the camera by Camera Management Tool using a DHCP environment or an IPv6 environment. If you configure the settings using other environments, please refer to "Operation Guide" > "Setting up the network without a DHCP server".

■ Setting Name Changes



Note

Setting names other than the following may also have been changed, depending on the model you are using.

The setting name of [Bit Rate Control] has been changed in [Basic] > [Video] > [H.264(1)] and [H.264(2)].

- [Use bit rate control] changed to [Use bit rate control (constant bit rate)]
- [Do not use bit rate control] changed to [Do not use bit rate control (variable bit rate)]

Information on Other Changes

In addition to the changes due to the firmware update, the following changes have also been made to the descriptions in the "Operation Guide".

The target models for these changes are indicated below.

Changed Information	Target Models			
	VB-H45, VB-M44 VB-H730F Mk II VB-S30D Mk II VB-S31D Mk II VB-S800D Mk II VB-S900F Mk II VB-S805D Mk II VB-S905F Mk II	VB-S30VE VB-S800VE VB-S910F	VB-R13VE (H2), VB-R13VE VB-R13, VB-R11VE (H2) VB-R11VE, VB-R11 VB-R12VE (H2), VB-R12VE VB-R10VE (H2), VB-R10VE VB-M50B, VB-H652LVE VB-H651VE, VB-H651V VB-M641VE, VB-M641V VB-M640VE, VB-M640V VB-H761LVE (H2) VB-H761LVE-H, VB-H761LVE VB-H760VE (H2), VB-H760VE VB-H751LE (H2) VB-H751LE-H, VB-H751LE VB-M741LE (H2) VB-M741LE-H, VB-M741LE VB-M740E (H2), VB-M740E	
Discontinuation of the RM Series	●	●	●	P. xiv
Discontinuation of the Setup CD-ROM		●	●	P. xiv
Routine Maintenance (formerly: "Cleaning the Camera")	●	●	●	P. xiv
Revision to the Operation Guide: Privileges Required for Operating the Camera Viewer	●	●	●	P. xvi
Revision to the Operation Guide: [Video Record] > [Upload]	●	●	●	P. xvi
Revision to the Operation Guide: [Event] > [Timer]	●	●	●	P. xvi
Revision to the Operation Guide: [Fixed at Infinity]	●	●	●	P. xvi
Revision to the Operation Guide: Troubleshooting	●	●	●	P. xvii
Revision to the Operation Guide: Viewer Messages	●	●	●	P. xvii
Revision to the Operation Guide: List of Factory Default Settings	●		●	P. xvii

Discontinuation of the RM Series

The Network Video Recording Software RM Series has been discontinued.
The RM-Lite video recording software is no longer provided.

Discontinuation of the Setup CD-ROM

The setup CD-ROM has no longer been included with the camera.
The distribution of files such as the software, user manuals, and License Agreement of Software that were stored on the setup CD-ROM has been changed as indicated below.

Type	Name	Distribution
Software	Network Video Recording Software RM-Lite	No longer provided
	Camera Management Tool	Download from the Canon website Installer name: VBToolsInstall.exe
	Recorded Video Utility	
	On-screen Display Assist Tool* ¹	
License	License Agreement of Software	Displayed on the Setting Page [Maintenance] > [General] > [Tool] > [View License]
	Open Source Software	
User manual	Operation Guide	Download from the Canon website
	Specifications	
	Mobile Camera Viewer Operation Guide	
	Camera Management Tool User Manual	
	Recorded Video Utility User Manual	
	On-screen Display Assist Tool User Manual* ¹	
Sample audio files	Sound samples* ²	

*1 Only for models and languages that are supported by the On-screen Display Assist Tool

*2 Only for models with the audio transmission/reception function

Routine Maintenance (formerly: "Cleaning the Camera")

The former section title, "Cleaning the Camera" has been changed to, "Routine Maintenance" due to the "■ Confirmation of Video Image" section being added and the explanation on how to clean the camera has been revised in the "■ Cleaning Method" section.

■ Confirmation of Video Image

Regularly check to make sure the set capture area is not misaligned, and is still in focus.
If necessary, re-adjust

■ Cleaning Method

Before beginning any work, turn off the power.

Cleaning the Dome Cover, Top Cover, and Lens Protector

- 1 Wash off foreign substances such as dust and sand using clean water*.
*Since indoor cameras (VB-H730F Mk II, VB-S30D Mk II, VB-S800D Mk II, VB-S805D Mk II, VB-R13, VB-R11, VB-H651V, VB-M641V, and VB-M640V) cannot be directly washed with water, wipe them clean with a soft cloth that has been dampened with clean water.
- 2 If the lens protector is dirty with something that cannot be removed with water, such as fingerprints or oil, gently wipe the lens protector clean with a soft sponge or cloth dampened with a neutral dishwashing detergent diluted to approximately 1% with water.
- 3 Wipe them clean with a soft cloth that has been dampened with clean water to ensure that water droplets and detergent do not remain**.
** For the VB-H761LVE-H, VB-H751LE-H, VB-M741LE-H, use clean water (water from the faucet, etc.) to rinse off the detergent and let it dry naturally.



Important

By performing an incorrect cleaning method, the dome cover or top cover, or lens protector could become scratched and will need to be replaced for a fee. Therefore, follow the next set of instructions carefully.

- Because of dust, dirt, or fingerprints etc. the auto focus may not work properly or the reflection of backlight or infrared light causes the image to become white and cloudy. In order to preserve the level of image quality, it is necessary to regularly clean the protective window.
- Do not wipe with a dry cloth. Never wipe with a cloth especially without removing the attached grime. This may result in scratches to the dome cover, top cover and/or lens protector.
- Use caution for the following points for the hydrophilic coating models.
 - Sponges and cloths used for cleaning, even if new, can have impurities adhered to it and can lower the effect of the coating. Therefore, use it after washing the sponge or cloth with a neutral dishwashing detergent.
 - Spraying with spray bottles can deteriorate the coating effect due to impurities such as lubricants. Therefore, we advise not to use spray bottles.

The hydrophilic coating models have a "hydrophilic coating model label" attached on the product's exterior cover.

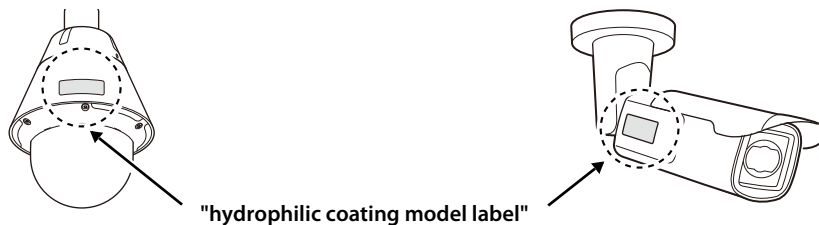

Cleaning the Lens

Use a commercial lens cleaner to remove grime on the lens surface.

- Scratches on the lens surface may result in poor video capture.
- Auto focus functionality may be degraded if the lens surface is dusty or dirty.

■ Privileges Required for Operating the Camera Viewer

The following menu and buttons can be used even if all the privileges of an authorized user or a guest user are disabled.

- ☰ [Main] Menu
 - [Language] Button
 - [Switch Users]
 - [Settings Page]
 - [Mobile Camera Viewer]

↕ [Reconnect] Button

Information Display

■ [Video Record] > [Upload]

The following "Important" text has been deleted.



Important

If the destination for HTTP or FTP upload, or e-mail notification is set for a Windows operating system, IPsec communication is not supported.

■ [Event] > [Timer]

The description of timer events has been revised.

[24-Hour Continuous Settings]

When set to [Enable], and [Repeat Interval] is set to an option other than [None], the timer event will be repeated at the interval specified in [Repeat Interval], irrespective of the [Start Time] setting. If [Repeat Interval] is set to [None], the timer event will be triggered only at the time set in [Start Time].

Note that when set to [Enable], only [Video Record] operations can be performed.

■ [Fixed at Infinity]

The description of the [Fixed at Infinity] focus setting has been revised.

[Fixed at Infinity]

Move the focus position to near infinity.

When needing to focus more precisely, select [Manual] setting and adjust the focus.

■ Troubleshooting

Countermeasures have been added for the following problems.

Problem	Countermeasures
Cannot connect to the camera. Video is not displayed. There is no audio.* The viewer gets disconnected.	<ul style="list-style-type: none"> Configure to exclude the camera, or the software where the problem occurred, in your security software.
The Camera Viewer will not launch.	<ul style="list-style-type: none"> Use one of the following procedures, when you launch the Camera Viewer and a file block security warning is displayed because of an unverified publisher. <ul style="list-style-type: none"> Launch the Camera Viewer after executing Windows Update to the latest version, when using the camera in an internet connection environment. Download the root certificate installer from the Canon download site on a connectable computer and install it in the target environment, when in an environment not connectable to the internet.
Cannot use some functions of the Camera Viewer.	<ul style="list-style-type: none"> Follow the procedure in "Adding the Camera IP Address as a Trusted Site" in the "Operation Guide" to add this website to [Trusted sites] in the [Security] settings, and disable the protected mode for the trusted sites (when not using Windows Server, also disable the protected mode in a similar manner). If you are using a web browser other than Internet Explorer or if the Canon Network Camera Addon Module is not correctly installed when using Internet Explorer, the following functions cannot be used. <ul style="list-style-type: none"> Receiving/transmitting audio* Receiving/playing H.264 video

* Only for models with the audio transmission/reception function

■ List of Viewer Messages > Warning Message

The description has been revised for the following item.

Message	Explanation
ActiveX is disabled.	ActiveX is disabled in the web browser settings or system functions cannot be accessed from ActiveX due to security settings. Even though ActiveX is enabled, if this message is displayed in the environment where the proxy server is used, select [Control Panel] > [Network and Internet] > [Internet options] > the [Connections] tab > [LAN settings] > the [Use a proxy server for your LAN] checkbox in [Proxy server] > select [Advanced] > specify the camera IP address in [Exceptions].

■ List of Factory Default Settings

The setting value has been revised for the following item.

Item	Setting
<ul style="list-style-type: none"> Camera Settings Shutter Speed 	1/100

THIS PRODUCT IS LICENSED UNDER THE AVC PATENT PORTFOLIO LICENSE FOR THE PERSONAL USE OF A CONSUMER OR OTHER USES IN WHICH IT DOES NOT RECEIVE REMUNERATION TO (i) ENCODE VIDEO IN COMPLIANCE WITH THE AVC STANDARD ("AVC VIDEO") AND/OR (ii) DECODE AVC VIDEO THAT WAS ENCODED BY A CONSUMER ENGAGED IN A PERSONAL ACTIVITY AND/OR WAS OBTAINED FROM A VIDEO PROVIDER LICENSED TO PROVIDE AVC VIDEO. NO LICENSE IS GRANTED OR SHALL BE IMPLIED FOR ANY OTHER USE. ADDITIONAL INFORMATION MAY BE OBTAINED FROM MPEG LA, L.L.C. SEE [HTTP://WWW.MPEGLA.COM](http://www.mpegla.com)

Only for European Union and EEA (Norway, Iceland and Liechtenstein)

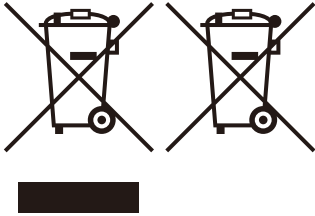

These symbols indicate that this product is not to be disposed of with your household waste, according to the WEEE Directive (2012/19/EU), the Battery Directive (2006/66/EC) and/or national legislation implementing those Directives.

If a chemical symbol is printed beneath the symbol shown above, in accordance with the Battery Directive, this indicates that a heavy metal (Hg = Mercury, Cd = Cadmium, Pb = Lead) is present in this battery or accumulator at a concentration above an applicable threshold specified in the Battery Directive.

This product should be handed over to a designated collection point, e.g., on an authorized one-for-one basis when you buy a new similar product or to an authorized collection site for recycling waste electrical and electronic equipment (EEE) and batteries and accumulators. Improper handling of this type of waste could have a possible impact on the environment and human health due to potentially hazardous substances that are generally associated with EEE. Your cooperation in the correct disposal of this product will contribute to the effective usage of natural resources.

For more information about the recycling of this product, please contact your local city office, waste authority, approved scheme or your household waste disposal service or visit www.canon-europe.com/weee, or www.canon-europe.com/battery.



Network Camera

Operation Guide



VB-R13VE/VB-R13/VB-R11VE/VB-R11

VB-R12VE/VB-R10VE

VB-M50B

VB-H652LVE/VB-H651VE/VB-H651V

VB-M641VE/VB-M641V/VB-M640VE/VB-M640V

VB-H761LVE-H/VB-H761LVE/VB-H760VE

VB-H751LE-H/VB-H751LE

VB-M741LE-H/VB-M741LE/VB-M740E

Introduction

Thank you for purchasing a Canon Network Camera (hereafter referred to as the camera)*.

This "Operation Guide" explains the camera settings and operations. Read this guide carefully before using the camera to ensure correct use. Also, be sure to read the files in the LICENSE folder on the Setup CD-ROM.

* The cameras described in this manual may include models not available in your country and/or region.

For the latest information on this product (firmware and included software, user manuals, operating environment, etc.), please refer to the Canon website.

Precautions for Use (Disclaimer)

■ Disclaimer

To the full extent permitted by laws and regulations, neither Canon Inc. nor any of its subsidiaries or affiliates shall be responsible for any financial losses that may be incurred as a result of the loss of recorded information or images, regardless of the internal or external cause of the loss.

EXCEPT AS SET FORTH IN THE LIMITED WARRANTY ACCOMPANYING THE CAMERA AND WITHOUT DETRACTING FROM ANY RIGHTS A CONSUMER MAY BE ENTITLED TO, AND TO THE FULL EXTENT PERMITTED BY LAWS AND REGULATIONS: (1) NEITHER CANON INC. NOR ANY OF ITS SUBSIDIARIES OR AFFILIATES MAKE ANY WARRANTY OF ANY KIND, EXPRESS OR IMPLIED, WITH REGARD TO THE MATERIAL IN THIS MANUAL OR WITH REGARD TO THE USE OF THE CAMERA INCLUDING, WITHOUT LIMITATION, IMPLIED WARRANTIES AS TO MARKETABILITY, MERCHANTABILITY, FITNESS FOR A PARTICULAR PURPOSE OR USE, OR NON-INFRINGEMENT AND (2) NEITHER CANON INC. NOR ANY OF ITS SUBSIDIARIES OR AFFILIATES SHALL BE LIABLE FOR ANY DIRECT, INCIDENTAL, OR CONSEQUENTIAL DAMAGES OF ANY NATURE RESULTING FROM THE USE OF THIS MATERIAL OR THE CAMERA.

■ Network Security

The user is responsible for the network security of this product and its use.

Take appropriate network security measures to avoid security breaches. To the full extent permitted by laws and regulations, neither Canon Inc. nor any of its subsidiaries or affiliates shall be liable for any losses, direct, incidental or consequential damages, or liabilities that may be incurred as a result of network security incidents such as unauthorized accesses.

<Network Security Recommendations>

- Change the password of the camera periodically.
- Change the HTTP or HTTPS port number of the camera.
- Limit access to the camera by network devices.

■ LEGAL NOTICE

The user is responsible for compliance with all applicable laws and regulations governing privacy protection and publicity rights implicated by the use of this product. In some cases, camera and/or audio monitoring or recording may be restricted or prohibited by the law or regulation, the details of which differ by country and region. Before installing the product, users should consult the laws and regulations of their country and region, including state and/or local laws and regulations in such country and region, to ensure that the product is installed in a manner compliant with all applicable legal requirements. The microphone should not be used if required by local law or regulation. Do not install the product in any spaces where occupants or visitors may reasonably have an expectation of privacy, such as bedrooms, dressing rooms and rest rooms.

The product should be installed in such a manner that it is clearly visible to all persons whose images and voices are monitored by the product. In addition, signage prominently displayed in close proximity to the product and clearly

visible to all persons monitored by the product should inform such persons that the product records both their images and their conversations.

Please be advised that Canon shall not be liable in any way in the event of a dispute between any user and any third party concerning the installation of the product or camera and/or audio monitoring or recording.

■ Copyright

Videos, images or sounds recorded with your camera may not be utilized or published without consent of copyright holders, if any, except in such a way as permitted for personal use under the relevant copyright law.

■ Use of Included RM-Lite Software

Flaws or other problems with RM-Lite may result in recording failure or destruction or loss of recorded data. Canon shall have no liability whatsoever for any loss or damages incurred by the user as a result of such problems.

■ Product Parts Life

R1x

Movable parts of this product (e.g., pan/tilt mechanism) as well as its electronic components may require replacement at an earlier period, according to where the product is installed, and how it is used.

Please refer to the Canon website for a reference as to the lifespan of the parts in relation to how the product is used.

License Agreement for Included Software

For information on the License Agreement for Included Software, refer to the following files in the BundledSoftware folder in the Included Setup CD-ROM LICENSE folder.

Software Type	File Name
Camera Management Tool	VBTools-E.txt
Recorded Video Utility	
Network Video Recording Software RM-Lite	RM-Lite-E.txt

This product is licensed under AT&T patents for the MPEG-4 standard and may be used for encoding MPEG-4 compliant video and/or decoding MPEG-4 compliant video that was encoded only (1) for a personal and non-commercial purpose or (2) by a video provider licensed under the AT&T patents to provide MPEG-4 compliant video. No license is granted or implied for any other use for MPEG-4 standard.

Trademarks

- Microsoft, Windows, Windows Vista, Internet Explorer, Windows Server, Microsoft Edge, Surface and ActiveX are trademarks or registered trademarks of Microsoft Corporation in the United States and other countries.
- Windows is legally recognized as the Microsoft Windows Operating System.
- This product comes with exFAT, a licensed file system technology from Microsoft.
- iPhone, iPad, iPad mini, iPad Air and Safari are trademarks of Apple Inc.
- SD, SDHC, SDXC, microSD, microSDHC and microSDXC logos are trademarks of SD-3C, LLC.
- ONVIF® is a trademark of Onvif, Inc.
- All other company or product names used in this manual are trademarks or registered trademarks of their respective holders.

Open Source Software

The product (camera and included RM-Lite) contains Open Source Software modules. For details, please refer to "ThirdPartySoftware-E.pdf" in the OpenSourceSoftware folder in the LICENSE folder on the Setup CD-ROM. Each module's license conditions are also available in the same folder.

Software under GPL and LGPL

If you would like to obtain the source code under GPL/LGPL, please contact us at nvsossg@canon.co.jp and provide the following information in English or Japanese:

1. Product name and firmware version.
2. Name of the software module or modules you would like to obtain.

You can obtain the source code for at least three years from the day you purchased this product. Please note we may bill you for any costs we incur in providing you the source code.

Security Export Control

This product is subject to security export control. Therefore, to export or carry it overseas may require an authorization by governmental agencies.

Types of User Manuals

The following describes the different camera user manuals. When you are instructed to reference another manual, its name will be listed as shown below.

Included User Manuals

Installation Guide

This describes precautions and procedures for installing the camera.

Guides Included on the Setup CD-ROM

Operation Guide (This Guide)

This explains the camera initial settings, camera angle settings, camera viewer operations, settings on the Setting Page, and troubleshooting, etc.

Mobile Camera Viewer Operation Guide

This explains details on how to use the Mobile Camera Viewer.

Appendix – Specifications

This lists the camera specifications.

Camera Management Tool User Manual

This explains details on how to use the Camera Management Tool.

Recorded Video Utility User Manual

This explains details on how to use the Recorded Video Utility.

Network Video Recording Software RM Series Administrator Manual

This explains details on how to use the RM-Lite video recording software (P. 23).

■ Notes

1. Any unauthorized reproduction of this guide is prohibited.
2. The contents of this guide are subject to change without any prior notice.
3. This document has been prepared with the utmost attention to accuracy. If you have any comments, however, please contact a Canon sales representative.
4. Canon shall assume no liability for any outcome of using this product, notwithstanding items 2 and 3 above.

How to Use This Operation Guide

The assumed reading format of this operation guide is on a computer screen.

■ Software Screenshots

The software screenshots samples shown in this guide are for illustration only. The screenshots may differ from the actual screens displayed.



















Descriptions use Windows 8.1 for the operating system, Internet Explorer 11 for the web browser, and the VB-M50B for sample screens.

The video size set selected for explanations is [1280 x 720 / 640 x 360 / 320 x 180]. If using a different video size set, substitute those sizes.

Symbols Indicating Camera Models





■ Symbols Indicating Camera Models

Explanations that differ depending on the camera model are indicated by the camera name and the following symbols.

Symbol	Camera Model	
		VB-R13VE, VB-R13
		VB-R12VE
		VB-R11VE, VB-R11
		VB-R10VE
	VB-M50B	
		VB-H652LVE
		VB-H651VE, VB-H651V
		VB-M641VE, VB-M641V
		VB-M640VE, VB-M640V
		VB-H761LVE-H, VB-H761LVE
		VB-H760VE
	VB-H751LE-H, VB-H751LE	
		VB-M741LE-H, VB-M741LE
		VB-M740E

■ Symbols Indicating Safety Precautions

This section explains the symbols used in this guide. The following symbols used in this guide indicate information for safe use of the product, as well as important and supplemental information the user should know. Be sure to read and understand this information when using the product.

Symbol	Meaning
 Warning	Failure to follow the instructions indicated by this symbol may result in death or serious injury. Be sure to follow these warnings to ensure safety.
 Caution	Failure to follow the instructions indicated by this symbol may result in injury. Be sure to follow these precautions to ensure safety.
Caution	Failure to follow the instructions indicated by this symbol may result in property damage. Be sure to follow these precautions.
 Important	Cautions and restrictions during operation. Make sure to read these carefully.
 Note	Supplementary descriptions and reference information.

Safety Precautions

This section explains precautions that must be followed when using the camera.

If they are not followed, injury, death and/or property damage may occur. Read the following information carefully and be sure to follow the precautions.

Important Warnings

Caution

**TO REDUCE THE RISK OF ELECTRIC SHOCK, DO NOT REMOVE COVER (OR BACK).
NO USER-SERVICEABLE PARTS INSIDE. REFER SERVICING TO QUALIFIED SERVICE PERSONNEL.**

The AC adapter (sold separately) can be connected to the camera from a standard AC power outlet. Please refer to the user manual to make sure that the camera is compatible with the adapter.

- The socket-outlet should be installed near the equipment and should be easily accessible.
- Unplug the equipment from the wall outlet before cleaning or maintaining.

FDA regulation

This Network Camera has not been evaluated by the Food and Drug Administration (FDA) for use as a medical device. When incorporated into a system with medical applications, FDA regulations may apply. Therefore, please consult your legal advisor to determine whether FDA regulations apply.

FCC NOTICE

Network Camera, Model Name: VB-R13VE, VB-R12VE, VB-R11VE, VB-R10VE, VB-H652LVE, VB-H651VE, VB-M641VE, VB-M640VE, VB-H761LVE-H, VB-H761LVE, VB-H760VE, VB-H751LE-H, VB-H751LE, VB-M741LE-H, VB-M741LE, VB-M740E

This device complies with Part 15 of the FCC Rules. Operation is subject to the following two conditions: (1) This device may not cause harmful interference, and (2) this device must accept any interference received, including interference that may cause undesired operation.

Note: This equipment has been tested and found to comply with the limits for a Class A digital device, pursuant to Part 15 of the FCC Rules.

These limits are designed to provide reasonable protection against harmful interference when the equipment is operated in a commercial environment. This equipment generates, uses, and can radiate radio frequency energy and, if not installed and used in accordance with the user manual, may cause harmful interference to radio communications. Operation of this equipment in a residential area is likely to cause harmful interference in which case the user will be required to correct the interference at his own expense.

Do not make any changes or modifications to the equipment unless otherwise specified in the manual. If such changes or modifications should be made, you could be required to stop operation of the equipment.

European Union regulatory notices:

Network Camera, Model Name: VB-R13VE, VB-R12VE, VB-R11VE, VB-R10VE, VB-H652LVE, VB-H651VE, VB-M641VE, VB-M640VE, VB-H761LVE-H, VB-H761LVE, VB-H760VE, VB-H751LE-H, VB-H751LE, VB-M741LE-H, VB-M741LE, VB-M740E

Warning

This is a class A product. In a domestic environment this product may cause radio interference in which case the user may be required to take adequate measures.

Network Camera, Model Name: VB-H761LVE-H, VB-H761LVE, VB-H760VE

Use of shielded cable is required to comply with EN61000-6-2.

Network Camera, Model Name: VB-H761LVE-H, VB-H761LVE, VB-H760VE, VB-H751LE-H, VB-H751LE

Use of shielded cable is required to comply with EN50121-4.

FCC NOTICE

Network Camera, Model Name: VB-R13, VB-R11, VB-M50B, VB-H651V, VB-M641V, VB-M640V

This device complies with Part 15 of the FCC Rules. Operation is subject to the following two conditions: (1) This device may not cause harmful interference, and (2) this device must accept any interference received, including interference that may cause undesired operation.

Note: This equipment has been tested and found to comply with the limits for a Class B digital device, pursuant to Part 15 of the FCC Rules. These limits are designed to provide reasonable protection against harmful interference in a residential installation.

This equipment generates, uses and can radiate radio frequency energy and, if not installed and used in accordance with the instructions, may cause harmful interference to radio communications.

However, there is no guarantee that interference will not occur in a particular installation. If this equipment does cause harmful interference to radio or television reception, which can be determined by turning the equipment off and on, the user is encouraged to try to correct the interference by one or more of the following measures:

- Reorient or relocate the receiving antenna.
- Increase the separation between the equipment and receiver.
- Connect the equipment to an outlet on a circuit different from that to which the receiver is connected.
- Consult the dealer or an experienced radio/TV technician for help.

Do not make any changes or modifications to the equipment unless otherwise specified in the manual. If such changes or modifications should be made, you could be required to stop operation of the equipment.

Canon U.S.A., Inc.

One Canon Park, Melville, New York 11747, U.S.A.

Tel No. 1-800-OK-CANON (1-800-652-2666)

Precautions

■ Camera Precautions

⚠ Warning
<p>If you discover defective conditions such as smoke, strange sounds, heat or strange odors, immediately stop using the camera and contact your nearest dealer. Fire or electric shock may result from continued use.</p>
<p>Failure to do the following may result in fire or electric shock.</p> <ul style="list-style-type: none">• If thunder starts, stop installation or inspection etc. and do not touch the camera or continue connecting the cable.• Do not disassemble or modify the camera.• Do not spray the camera with water, or otherwise make it wet. (VB-R13/VB-R11/VB-M50B/VB-H651V/VB-M641V/VB-M640V)• Please do not insert objects like water or metal objects within the camera housing.• Do not use flammable sprays near the camera.• Do not leave LAN cables, external power supplies or AC adapter (sold separately) power connectors connected when the camera is not in use for long periods.• Do not damage the connecting cable.
<p>This camera should not be used with medical devices or other life-support systems. Depending on the computer and network environment, high-precision video transmission cannot be guaranteed due to video lag or loss. Canon will assume no liability for any accident or damage resulting from use of the camera under the conditions above.</p>

⚠ Caution
<p>H652 H761 H751 M741</p> <p>Avoid looking directly at the infrared illumination at close distance for long periods of time. Intense infrared illumination can cause eye damage.</p>

Caution
<p>Failure to do the following may result in camera malfunction.</p> <ul style="list-style-type: none">• Do not capture the sun, halogen lamps, and other very bright light sources or subjects.• Do not expose the camera to strong impact or vibration.• Do not touch the head or lens of the camera.• Do not forcibly turn the rotating parts of the camera by hand. R1x M50 H651 M64x

■ Precautions When Using [Camera] > [Camera Angle] on the Setting Page

H651 M64x

Caution
<p>[Camera] > [Camera Angle] (P. 45) on the Setting Page is expected for use only when installing the camera. Do not use on a daily basis. Frequent use may result in camera malfunction.</p>

■ Precautions for Built-In Camera Functions and Included Software

Caution
Do not use the following built-in camera functions or included software in situations requiring high reliability: <ul style="list-style-type: none">– Intelligent Function– Image Stabilization Function– Network Video Recording Software RM-Lite These do not guarantee high-precision capture and cannot support applications beyond their intended range of use. Canon will assume no liability for any accident or damage resulting from the use of these functions or software.

■ Impact to the image when installed outdoors

VB-R13VE/VB-R12VE/VB-R11VE/VB-R10VE/VB-H652LVE/VB-H651VE/VB-M641VE/VB-M640VE/VB-H761LVE-H/VB-H761LVE/VB-H760VE/VB-H751LE-H/VB-H751LE/VB-M741LE-H/VB-M741LE/VB-M740E

Caution
Visibility of the acquired image from a network camera installed outdoors can be impaired, due to the accumulation of rain, frost or snow on the dome case or the lens protector on the front of the camera. Additionally, dust and automobile exhaust fumes collected on the dome case or lens protector can result in the reduction of image quality. Please be sure to take the impact of the surrounding environment on the image into consideration, when installing the camera outdoors.

■ Maintenance Precautions

 Warning
Do not use flammable solvents such as alcohol, paint thinner or benzene when cleaning the camera. Use of these may result in fire or electric shock.

 Caution
Periodically inspect the parts and screws for rust and loosening. For inspections, please contact the dealer where you purchased the product. Failure to follow these precautions could result in injuries and equipment damage due to falling items.

Cleaning the Camera

Turn off the power before cleaning the camera.

Note

For users of the VB-H761LVE-H, VB-H751LE-H, and VB-M741LE-H:

Please refer to "About Hydrophilic Coating Models", included with the camera, as to cleaning the camera, and do not follow the instruction below.

■ Cleaning the Exterior

- 1 Dampen a soft cloth with water or diluted neutral detergent and gently wipe away any grime.
- 2 Wipe with a dry cloth.

Important

Grime on the dome case and lens protector may result in focusing problems and/or reduction of image quality. It is recommended that the cover be cleaned on a regular basis.

■ Cleaning the Lens

Use a commercial lens cleaner to remove grime on the lens surface.

- Scratches on the lens surface may result in poor video capture.
- Auto focus functionality may be degraded if the lens surface is dusty or dirty.

Camera Disposal

Dispose of the camera in accordance with local laws and regulations.

Be sure to remove the memory card* from the camera before the disposal.

* In this guide, “memory card” refers to compatible memory cards that can be used by the cameras.



Table of Contents

Introduction.....	2
Precautions for Use (Disclaimer)	2
License Agreement for Included Software	3
Trademarks	3
Open Source Software.....	3
Security Export Control	4
User Manuals.....	5
Types of User Manuals	5
How to Use This Operation Guide	5
Symbols Indicating Camera Models.....	6
Safety Precautions.....	7
Precautions	9
Cleaning the Camera	10
Camera Disposal	11

Chapter 1

Before Use

Functions of the Network Camera	20
Camera Software	22
Camera Operations and Settings	22
Software Included on the Setup CD-ROM	22
Additional Software/Licenses (Sold Separately).....	23
Operating Environment.....	25
PC Environment Details	25
Verified Mobile Devices (Setting Page, Camera Viewer, Mobile Camera Viewer) – As of December 2016.....	26
Steps for Setting Up the Camera.....	27
Step 1 Preparing to Install the camera	27
Step 2 Checking the Camera Connection	27
Step 3 Installing the Camera.....	27
Step 4 Setting the Camera Angle	27
Step 5 Using the Camera Viewers	28
Step 6 Adjusting Advanced Settings According to its Use	28
Troubleshooting	28

Chapter 2

Camera Setup

Installing Software	30
Necessary Software	30
Software Installation	30
Checking/Configuring Security Settings.....	33
Checking Firewall Settings.....	33
Settings When Using Windows Server.....	34
Configuring Initial Camera Settings.....	37
Launching the Camera Management Tool	37
Searching for Cameras	37

Setting up Networks.....	40
Checking the Video.....	40
Setting up the network without a DHCP server.....	41

Chapter 3 **Setting the Camera Angle**

Flow for the Setting of the Camera Angle.....	44
Step 1 Configuring the Camera Before Setting the Camera Angle.....	44
Step 2 Setting the Camera Angle and Focus.....	44
Setting the Camera Angle.....	45
Camera Angle Screen Composition.....	45
Setting the Camera Angle and Zoom.....	46
Setting the Focus.....	47

Chapter 4 **Camera Viewer**

Viewing Video with the Camera Viewer.....	50
Launching the Camera Viewer.....	50
Switching to the Administrator or an Authorized User.....	52
Camera Viewer Screen.....	55
Checking Information.....	60
Changing the Reception Video Size and Display Screen Size.....	61
Changing the Reception Video Size/Format and Display Screen Size.....	61
Displaying in Full Screen Mode.....	62
Operating the Camera.....	65
Obtaining Camera Control Privileges.....	65
Using Pan/Tilt/Zoom.....	66
Adjusting Video.....	70
Using Backlight Compensation.....	71
Using Presets or the Home Position.....	72
Viewer PTZ and Digital PTZ.....	73
Magnifying and Display Part of Video (Viewer PTZ).....	73
Cropping and Displaying Part of an Image (Digital PTZ).....	74
Saving Snapshots.....	77
Recording Video to a Memory Card.....	78
Recording Videos Manually.....	78
Confirming Recorded Video.....	79
Receiving/Transmitting Audio.....	80
Receiving Audio.....	80
Transmitting Audio.....	80
Checking the Status of Event Detection.....	82
Operating External Device Output.....	82
Checking the Status of Event Detection.....	82

Chapter 5 **Setting Page**

How to Use The Setting Page.....	86
Accessing the Setting Page.....	86
Common Setting Page Operations.....	87
Operating the Video Display Area.....	88

About Each Setting Page.....	90
Video Output.....	93
[Basic] > [Network]	
Configuring Network Settings.....	94
LAN.....	94
IPv4.....	94
IPv6.....	95
DNS.....	96
mDNS.....	97
[Basic] > [User Management]	
Configuring Accounts and Privileges.....	98
Administrator Account.....	98
Authorized User Account.....	98
User Authority.....	99
[Basic] > [Date and Time]	
Setting the Date/Time.....	100
Current Date and Time.....	100
Settings.....	100
[Basic] > [Video]	
Setting Video Size and Quality.....	102
All Videos.....	102
JPEG.....	103
H.264(1).....	103
H.264(2).....	104
[Basic] > [Viewer]	
Configuring the Viewer.....	105
General.....	105
Viewer Settings.....	105
[Camera] > [Camera]	
Setting General Camera Controls.....	107
Camera Name.....	107
Camera Control.....	107
Day/Night (When Auto Is Set).....	109
Clear IR Mode.....	110
Installation Conditions.....	110
Camera Position Control.....	110
External Input Device 1, 2.....	110
External Output Device 1, 2.....	110
[Camera] > [Initial Settings]	
Setting Initial Video Settings.....	112
Camera Position.....	112
Camera Settings.....	113
[Camera] > [Day/Night Mode Focus]	
Day/Night Mode Focus.....	120
Day/Night Mode Focus.....	120
Camera Control.....	121

[Camera] > [Panorama]	
Creating a Panorama Image	123
Creating a Panorama Image	123
Saving the Panorama Image as an Image File/Opening the Image File	125
Capture Settings	126
[Camera] > [View restriction]	
Setting View Restriction.....	127
Configuring View Restrictions	128
[Camera] > [Preset]	
Registering Presets	131
Registering a Preset.....	131
[Camera] > [Preset Tour]	
Setting the Preset Tour Route	135
Screen Composition.....	135
Tour Route Settings.....	138
[Video and Audio] > [ADSR]	
Reducing Data Size by Lowering Video Quality in Specific Areas	141
Specified Area	141
ADSR.....	142
[Video and Audio] > [On-screen display]	
Displaying Date, Time and Text on the Video.....	143
On-Screen Display	143
[Video and Audio] > [Privacy Mask]	
Setting Privacy Mask.....	145
Registering Privacy Masks.....	145
Changing/Deleting a Privacy Mask.....	147
[Video and Audio] > [Audio]	
Setting Audio Input/Output.....	149
General Audio	149
Sound Clip Upload 1 to 3.....	150
[Server] > [Server]	
HTTP, SNMP and FTP Server Settings	151
HTTP Server	151
SNMP Server	151
SNMP v1 and v2c Server	152
SNMP v3 Server	152
FTP Server.....	152
WS-Security.....	153
[Server] > [Video Server]	
Video Transmission Settings	154
Video Server.....	154
[Server] > [Audio Server]	
Audio Transmission/Reception Settings	155
Audio Server	155
[Server] > [RTP Server]	
RTP Settings.....	156

RTP Server	156
Audio Multicast	156
RTP Stream 1 to 5	157
[Video Record] > [Upload]	
HTTP and FTP Upload Settings	158
Video Record Setting	158
General Upload	158
HTTP Upload	159
FTP Upload	160
[Video Record] > [E-mail Notification]	
Setting E-mail Notification	162
E-mail Notification	162
[Event] > [External Device]	
External Device Input Triggered Operation Settings	163
External Device Output 1, 2	163
External Device Input	164
External Device Input 1, 2	164
[Event] > [Audio Detection]	
Abnormal Audio Input Triggered Operation Settings	166
Volume Detection	166
Scream Detection	167
[Event] > [Timer]	
Timer Triggered Operation Settings	169
Timer 1 to 4	169
[Event] > [Intelligent Function]	
- Overview -	171
Intelligent Function	171
Notes on Intelligent Function Settings and Operations	174
Registering Presets	175
Selecting the Intelligent Function Operation Mode	175
[Event] > [Intelligent Function]	
- Video Detection -	177
Steps for Configuring Video Detection	177
Configuring Detection Criteria ([Detection Conditions] Tab)	181
Configuring Operations for "Detected" ([Event] Tab)	191
Checking Event Status	191
Displaying Settings for Detection Areas/Detection Lines, Non-Detection Area and Detection Results (Display Options)	192
Reducing Effects of Lighting Change (Detections Settings)	192
Context Menu	193
[Event] > [Intelligent Function]	
- Auto Tracking -	194
Setting Auto Tracking	194
Auto Tracking Termination	197
Disabling Auto Tracking	197
Displaying Settings for Detection Areas and Detection Results (Display Options)	198

[Event] > [Intelligent Function]	
- Shared Operations -	199
Configuring Operations for "Detected" ([Event] Tab).....	199
Restarting Intelligent Function	200
[Event] > [Switch Day/Night]	
Executing Presets When Switching Day/Night Mode	201
Day/Night Mode Switching	201
[Event] > [Linked Event]	
Using Event Combinations.....	202
Linked Event 1 to 4	202
Linked Event Operation Examples.....	204
[Security] > [Host Access Restrictions]	
Setting Access Restrictions	206
IPv4 Host Access Restrictions.....	206
IPv6 Host Access Restrictions.....	207
[Security] > [SSL/TLS]	
Setting HTTP Communication Encryption.....	208
Certificates	208
Certificate Management.....	209
Encrypted Communications.....	209
[Security] > [802.1X]	
Network Port Authentication Settings.....	211
802.1X Authentication	211
Authentication Method	211
[Security] > [IPsec]	
Setting IPsec	213
IPsec	213
Auto Key Exchange Settings	213
IPsec Set 1 to 5	214
[Memory Card]	
Memory Card Operations and Information Display	217
Video Record Setting	217
Memory Card Operations	217
Memory Card Information	219
[Maintenance] > [General]	
Displaying Camera Device Information and Perform Maintenance.....	220
Device Information	220
Tool	220
Initialization	220
[Maintenance] > [Backup / Restore]	
Saving/Restoring Camera Settings	222
Backup / Restore	222
[Maintenance] > [Update Firmware]	
Updating the Camera Firmware.....	223
Device Information	223
Update Firmware	223

[Maintenance] > [Log]	
Checking/Sending Camera Log Information.....	224
View Logs.....	224
Log Notifications	224

Chapter 6

Appendix

Modifiers	228
Troubleshooting	230
List of Log Messages	232
Log Messages on the Camera.....	232
Error Log	232
Warning log.....	237
Notification log	241
List of Viewer Messages	245
Messages Displayed in the Information Display.....	245
Restoring Factory Default Settings	247
Restoring the Initial Settings from a Web Browser.....	247
Restoring Factory Default Settings with the Reset Switch on the Camera	247
List of Factory Default Settings.....	251
Index.....	263

Chapter

1



Before Use

This chapter explains the camera functions, software and operating environment. It also describes the flow from preparation and setup through to actual use.

Functions of the Network Camera

A network camera not only enables you to operate the camera, but also allows you to record and upload the video, and perform monitoring using the various intelligent functions of the camera. However, the functions that can be used differ depending on the model. For the difference in functions by model, please refer to the table below.

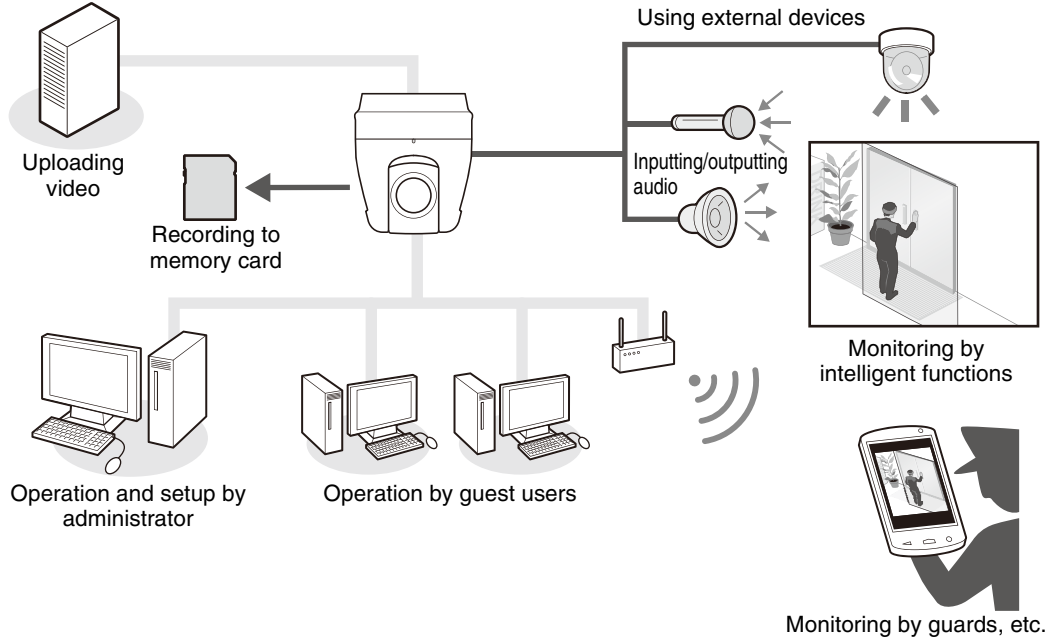

■ Table of Function Compatibility by Model

The functions for which availability differs depending on the model are shown below.

	R13	R12	M50	H652	H651	H761	H760	H751
Pan/Tilt/Zoom	✓	✓	✓	-	-	-	-	-
Zoom	-	-	-	-	-	✓	✓	-
Digital PTZ	-	-	✓	✓	✓	✓	✓	✓
Audio I/O Terminals	✓	-	✓	✓	✓	✓	-	✓
External Device Terminals	✓	-	✓	✓	✓	✓	-	✓
Full resolution	1920 x 1080		1280 x 960	1920 x 1080				
Infrared Illumination	-	-	-	✓	-	✓	-	✓
Camera Angle Setting*	-	-	-	-	✓	-	-	✓
Audio Detection	✓	-	✓	✓	✓	✓	-	✓
Auto Tracking	✓	✓	-	-	-	-	-	-
Event triggered preset movement	✓	✓	✓	-	-	✓	-	-
Linked Event	✓	-	✓	✓	✓	✓	-	✓
Panorama Creation	✓	✓	✓	-	-	-	-	-
View Restriction Setting	✓	✓	✓	-	-	✓	✓	-
Enhanced Digital Zoom	✓	✓	✓	-	-	✓	✓	-
Clear IR Mode	-	-	✓	-	-	✓	-	-
Rotate Video Display	-	-	-	✓	✓	✓	✓	✓
microSD/microSDHC/microSDXC memory cards supported	-	-	-	✓	✓	-	-	-
SD/SDHC/SDXC memory cards supported	✓	✓	✓	-	-	✓	✓	✓
Maximum number of registered presets	257		65	21				

	R11	R10	M641	M640	M741	M740
Pan/Tilt/Zoom	✓	✓	-	-	-	-
Digital PTZ	-	-	✓	✓	✓	✓
Audio I/O Terminals	✓	-	✓	-	✓	-
External Device Terminals	✓	-	✓	-	✓	-
Full resolution	1280 x 960					
Infrared Illumination	-	-	-	-	✓	-
Camera Angle Setting*	-	-	✓	✓	✓	✓
Audio Detection	✓	-	✓	-	✓	-
Auto Tracking	✓	✓	-	-	-	-
Event Triggered Preset Movement	✓	✓	-	-	-	-
Linked Event	✓	-	✓	-	✓	-
Panorama Creation	✓	✓	-	-	-	-
View Restriction Setting	✓	✓	-	-	-	-
Enhanced Digital Zoom	✓	✓	-	-	-	-
Clear IR Mode	-	-	-	-	-	-
Rotate Video Display	-	-	✓	✓	✓	✓
microSD/microSDHC/microSDXC memory card support	-	-	✓	✓	-	-
SD/SDHC/SDXC memory card support	✓	✓	-	-	✓	✓
Max. Number of Registered Presets	257		21			

* Configuring [Camera Angle] and [Initial Settings] on the Setting Page.

The following software is available for efficiently configuring and operating the camera.

Camera Operations and Settings

Camera operations are performed using the Camera Viewer/Mobile Camera Viewer.
Camera settings are specified from the Setting Page.

■ Camera Viewer (P. 49) /Mobile Camera Viewer

Controls the camera, and monitors video and various events.

You can use the Camera Viewer (mainly for computers) and the Mobile Camera Viewer (mainly for devices with a screen size of 7 inches or less).

The functions available in the Viewer differ according to the user authority (P. 53).



Note

For details on using Mobile Camera Viewer, please refer to “Mobile Camera Viewer Operation Guide”.

■ Setting Page (P. 85)

The Setting Page is for the administrator to configure and manage the camera.

Software Included on the Setup CD-ROM

To use the software on the included setup CD-ROM, install the software on the computer.



Note

.NET Framework 3.5 SP1 (when using Internet Explorer 9) or .NET Framework 4.5 (when using Internet Explorer 10/11) is necessary to use Camera Management Tool and Recorded Video Utility.

If it is not installed on the computer, it will be automatically installed when using the installer (P. 30).

■ Camera Management Tool (P. 37)

This tool is used for batch managing multiple cameras, from initial settings to performing maintenance. The Camera Management Tool can perform the following tasks.

- Detecting cameras
- Set various camera settings.
- Display the Viewer and the Setting Page.
- Update firmware, back up/restore settings, perform memory card and other operations, as well as camera maintenance.

This guide explains how to use this tool to configure the initial settings for cameras (P. 37). For details on other uses and functions, please refer to “Camera Management Tool User Manual”.

The Camera Management Tool can be installed from the installer.

Installer location: Setup CD-ROM > [Applications] folder > VBToolsInstall.exe

■ Recorded Video Utility

This utility is used for viewing and managing the videos recorded on the memory card mounted in the camera. The Recorded Video Utility enables you to perform the following operations on recorded videos.

- Displaying a list of videos
- Playing and deleting videos
- Downloading videos to a computer

For details on using the utility and its functions, please refer to "Recorded Video Utility User Manual".

The Recorded Video Utility can be installed from the installer.

Installer location: Setup CD-ROM > the [Applications] folder > VBToolsInstall.exe

■ RM-Lite

This software displays, records and plays back video from up to four cameras via a network.

Software location: Setup CD-ROM > [Applications] folder > RMLiteInstall.exe

RM-Lite Software

Type	Overview
RM-Lite Storage Server	Up to four cameras can be registered to record video (JPEG).
RM-Lite Viewer	Plays video recorded in the storage server and displays live video (JPEG/H.264) from the camera. Up to four cameras can be registered for the viewer.
RM-Lite Manager	Use to register cameras and configure recording schedules.

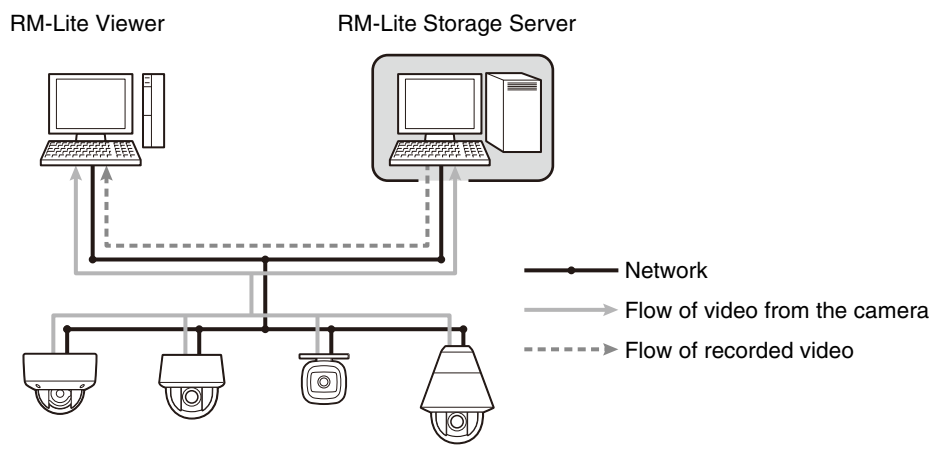

Important
To add the RM-Lite Viewer or RM-Lite Manager, you must purchase RM-Lite-V (sold separately).

Note
For details on the usage, operating environment, and functions of RM-Lite, please refer to "Administrator Manual".

Additional Software/Licenses (Sold Separately)

You can purchase additional software and licenses as necessary.

■ Canon H.264 Additional User License AUL-VB

Additional license for viewing H.264 video with multiple computers via the Viewer or Recorded Video Utility. Each camera includes one license. Additional licenses are necessary for multiple computers to view H.264 video from a single camera.

■ RM-64/RM-25/RM-9

This software allows network cameras to be used for multipoint surveillance, and for displaying, recording and playing back videos from the camera.

The number of cameras that can be registered with RM-64/RM-25/RM-9 varies: 64, 25, or 9 cameras respectively can be registered. By using multiple Storage Servers, you can construct a surveillance system supporting up to 512 cameras.



Note

Licenses for upgrading from RM-9 to RM-25 or RM-64, and from RM-25 to RM-64 are also available.

■ RM-V

This additional license lets you install the RM-64/RM-25/RM-9 RM Manager and RM Viewer on multiple computers. Purchase the license to be able to view video from the camera from multiple locations and for other similar purposes.

■ RM-Lite-V

This additional license lets you install the RM-Lite Viewer or RM-Lite Manager on multiple computers. Purchase the license to be able to view video from the camera from multiple locations and for other similar purposes.

Operating Environment

For the latest information on this product (firmware and included software, user manual, operating environment, etc.), please refer to the Canon website.

PC Environment Details

CPU (Recommended)	Intel Core i7-2600 or higher	
Graphics Board (Recommended)	Not specified	
Memory (Recommended)	2 GB or higher	
Viewer Display (Recommended)	1920 x 1080 or higher	
OS and Compatible Web Browser	Windows Vista Ultimate/Business/Enterprise/Home Premium SP2 32/64-bit	Internet Explorer 9 32-bit
	Windows 7 Ultimate/Professional/Enterprise/Home Premium SP1 32/64-bit	Internet Explorer 11 32/64-bit, Chrome 54* ²
	Windows 8.1/Windows 8.1 Pro/Windows 8.1 Enterprise 32/64-bit* ¹	Internet Explorer 11 32/64-bit, Chrome 54* ²
	Windows 10 Pro/Windows 10 Enterprise/Windows 10 Education/Windows 10 Home 32/64-bit	Internet Explorer 11 32/64-bit, Microsoft Edge* ² , Chrome 54* ²
	Windows Server 2008 Standard SP2 32/64-bit	Internet Explorer 9 32-bit
	Windows Server 2008 R2 Standard SP1 64-bit	Internet Explorer 11 32/64-bit, Chrome 54* ²
	Windows Server 2012 Standard 64-bit* ¹	Internet Explorer 10 32/64-bit, Chrome 54* ²
	Windows Server 2012 R2 Standard 64-bit* ¹	Internet Explorer 11 32/64-bit, Chrome 54* ²
	Windows Server 2016 Standard 64-bit	Internet Explorer 11 64-bit, Chrome 54* ²
	– Must be configured to allow use of JavaScript, IFRAME (html tag), and web storage – For Camera Viewer only, cookies must be enabled	
Operating System Language	Setting Page, Camera Viewer, Mobile Camera Viewer: German/English/Spanish/French/Italian/Polish/Russian/Thai/Turkish/Chinese (Simplified) /Japanese	

*1 Cannot be started from the Windows start screen

*2 Does not support playback of Video (H.264) or audio transmission/reception

 **Note**

- For details on the operating environment of the Camera Management Tool, please refer to "Camera Management Tool User Manual".
- For information on the operating environment of the Recorded Video Utility, please refer to "Recorded Video Utility User Manual".

Verified Mobile Devices (Setting Page, Camera Viewer, Mobile Camera Viewer)

– As of December 2016

Mobile Devices	OS	Compatible Web Browser
Surface 3	Windows 10 Home 64-bit	Internet Explorer 11, Microsoft Edge* ¹
	<ul style="list-style-type: none"> – Must be configured to allow use of JavaScript, and web storage – For Camera Viewer only, cookies must be enabled 	
iPad mini 4 iPad Air 2 iPad Pro iPhone SE* ² iPhone 7/iPhone 7 Plus* ²	iOS 9.3.5	Safari* ¹
	iOS 10.1.1	
<ul style="list-style-type: none"> – Must be configured to allow use of JavaScript, IFRAME (html tag), and web storage – For Camera Viewer only, cookies must be enabled 		
Nexus 9	Android 7.0	Chrome 54* ¹
Galaxy Tab S 8.4	Android 4.4.2	Chrome 54* ¹
Galaxy Tab S 10.5	Android 4.4.2	Chrome 54* ¹
Nexus 6P* ²	Android 7.0	Chrome 54* ¹
Galaxy S7 edge* ²	Android 6.0.1	Chrome 54* ¹

*1 Does not support playback of Video (H.264) or audio transmission/reception

*2 Setting Page and Camera Viewer is not supported

Steps for Setting Up the Camera

Step 1 Preparing to Install the camera

Make preparations to use the camera via a network.

Install the necessary software

- “Installing Software” (P. 30)

Check/configure the computer and web browser security settings

- “Checking/Configuring Security Settings” (P. 33)

Use the Camera Management Tool to configure initial camera settings.

- “Configuring Initial Camera Settings” (P. 37)

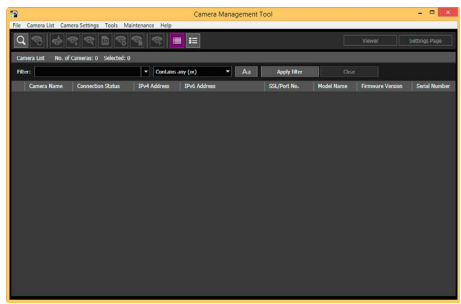

Camera Management Tool

Step 2 Checking the Camera Connection

Access the camera with a computer to ensure preparations have been properly completed.

Accessing the Camera to Check Videos

- Accessing the camera from the Camera Management Tool (P. 40)
- Entering an IP Address from a web browser to access the camera (P. 50)

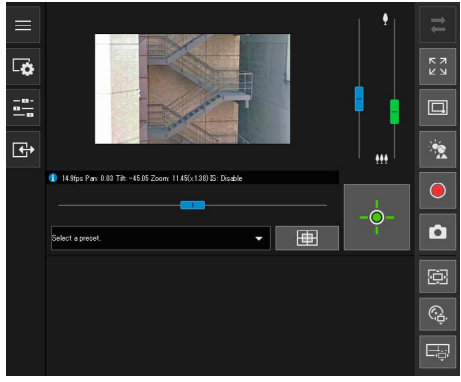

Camera Viewer

Step 3 Installing the Camera

Install the camera to suit the environment it will be used in.

- “Installation Guide”

Step 4 Setting the Camera Angle

H651 M64x H751 M74x

Use the Setting Page to set the camera angle while checking video on the computer screen.

- “Setting the Camera Angle” (P. 43)

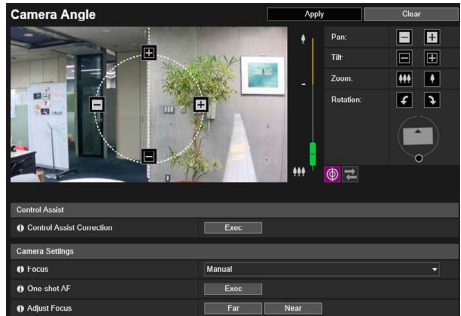

Camera Angle Setting

Step 5 Using the Camera Viewers

Operate the camera while viewing the video in the Viewer.

→ “Camera Viewer” (P. 49)

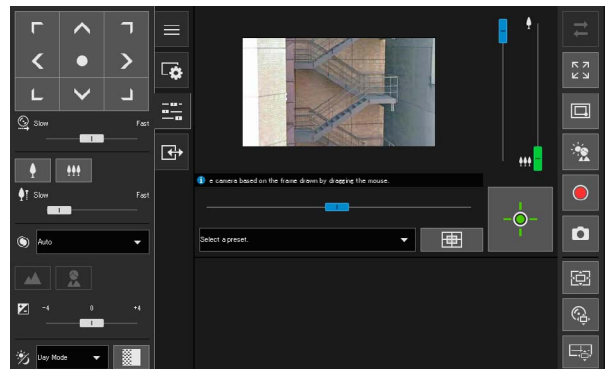

Camera Viewer

Step 6 Adjusting Advanced Settings According to its Use

Advanced settings can be made in the Settings Menu, such as for camera control and security, according to how the camera will be used.

Settings can also be made using the Camera Management Tool. For details, please refer to “Camera Management Tool User Manual”.

→ “Setting Page” (P. 85)

VB-M50B Settings Menu		Viewer	Language (English)
Basic	Basic Settings for Using the Camera		
Camera	Camera control and parameter settings		
Video and Audio	Video and audio settings		
Server	Various Server Function Settings		
Video Record	Video Recording Settings (Uploads/E-mail Notifications, etc.)		
Event	Event Settings (Timer, etc.)		
Security	Access Restrictions and Security Communications Settings		
Memory Card	Memory card operations and settings		
Maintenance	Camera maintenance such as viewing logs or the current settings list, and rebooting the camera		
User Page	The settings pages that a user can add		

Setting Page

Troubleshooting

Please refer to “Appendix” (P. 227), in case of error messages or problems.

Chapter 2

Camera Setup

To prepare the camera for use, install the necessary software on the computer, and configuring the initial settings for web browser security and the camera.

When initial settings are complete, access the camera and check if video can be viewed.

Installing Software

Use the setup CD-ROM included with the camera to install the necessary software.

Necessary Software

You will need the following software:

- Camera Management Tool (P. 37)
- Recorded Video Utility
- .NET Framework 3.5 SP1/.NET Framework 4.5 (unnecessary if already installed on computer)

Note

If .NET Framework 3.5 SP1/.NET Framework 4.5 is not installed on the computer, the installer will automatically install the version appropriate for the version of Internet Explorer used on the computer.

Software Installation

■ Installation Methods

The software can be installed together using [Easy Installation], or you can select which software to install using [Custom Installation].

■ Installing Software

- 1** Insert the setup CD-ROM into the drive on the computer.
- 2** Confirm that all other applications have been closed.
- 3** Double-click the CD-ROM icon > [Applications] folder > [VBToolsInstall.exe].



The installation screen is displayed.

Note

If the [User Account Control] screen is displayed, click [Yes] or [Continue].

4 Select the installation method.



5 Confirm or select the software that will be installed.

If you select [Easy Installation], confirm the software that will be installed and click [Next].

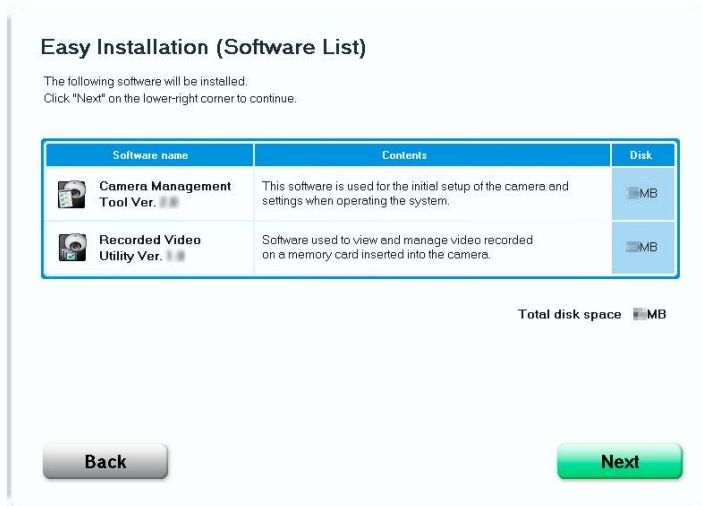

If you select [Custom Installation], select the software to be installed and click [Next].

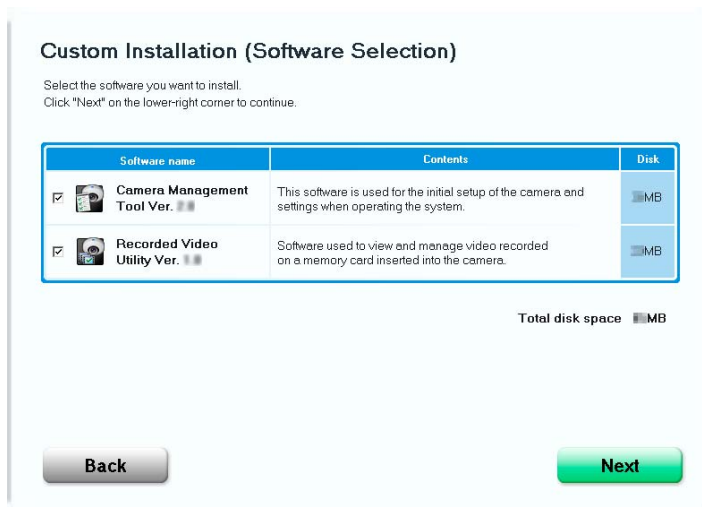

The User License Agreement screen is displayed.

6 Read through the user license agreement and click [Yes] if you accept it.

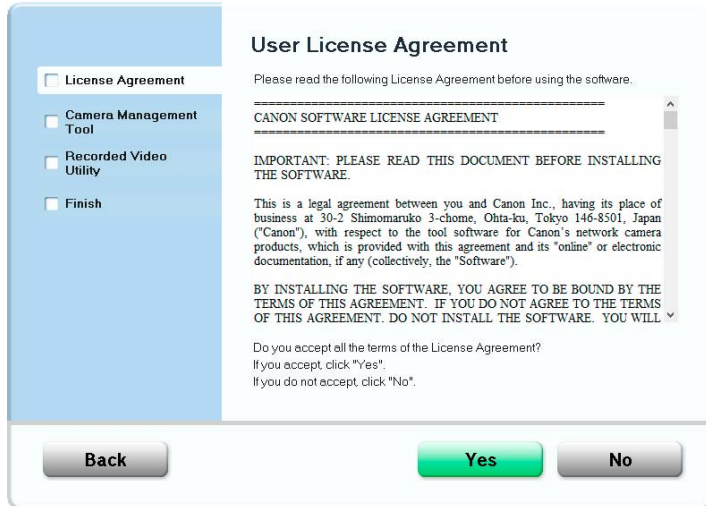

Installation starts.

7 Click [Exit] or [Reboot].

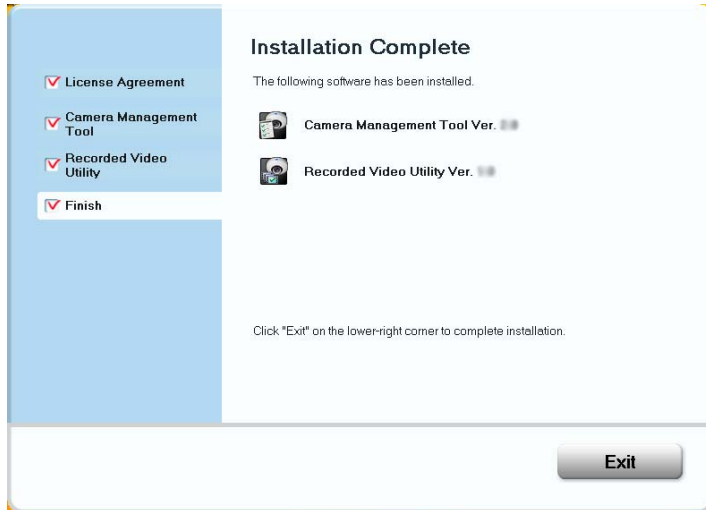

The Camera Management Tool icon and Recorded Video Utility icon will be displayed on the desktop.



Checking/Configuring Security Settings

Camera configuration and operation may be blocked, depending on the security functions of the operating system and web browser.

Change or check security settings beforehand.

Checking Firewall Settings

To use the software included on the setup CD-ROM on computers where Windows Firewall is enabled, you may need to add each software as an application allowed to communicate via the firewall.

Note

Even if you do not perform the following steps, you can still add each software with the [Windows Security Alert] dialog box that is displayed when you launch the software included on the setup CD-ROM.

- 1 Click [System and Security] > [Windows Firewall] in [Control Panel].
- 2 Click [Allow an app or feature through Windows Firewall].

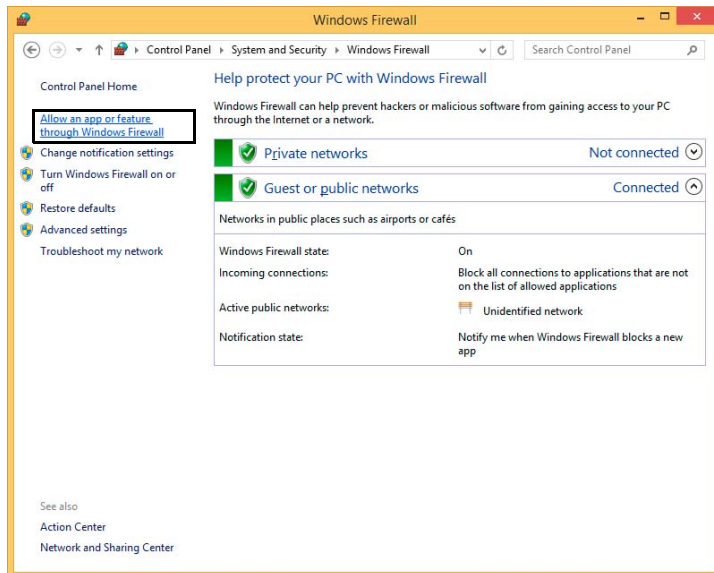

3 Click [Change settings] > [Allow another app].

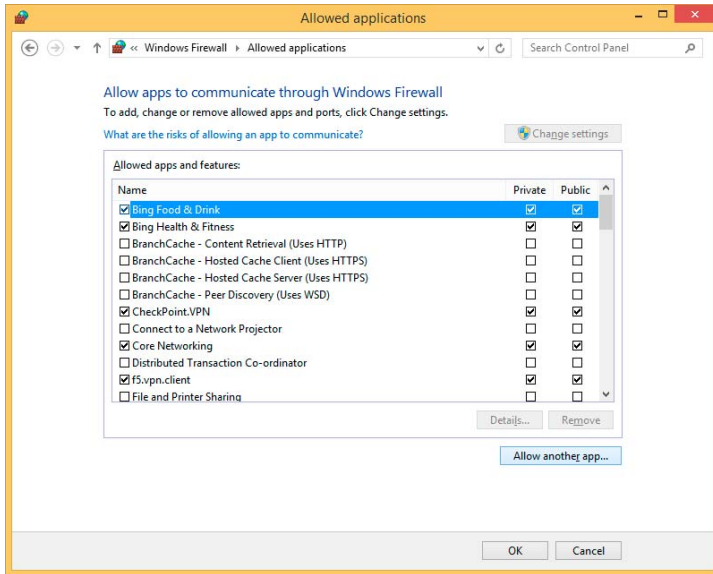

4 Select the software to use, such as [Camera Management Tool], and click [Add].

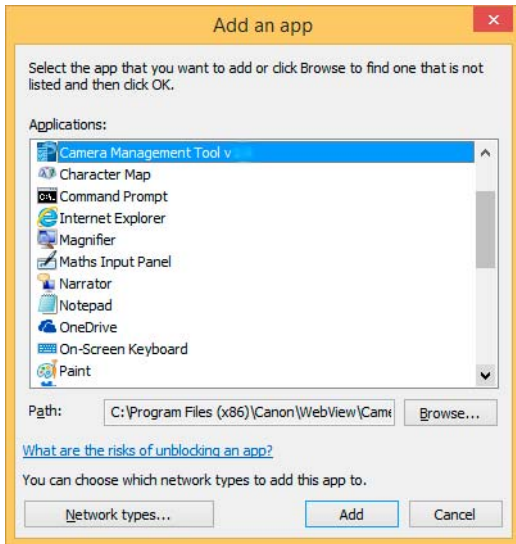

Settings When Using Windows Server

■ Adding the Camera IP Address as a Trusted Site

When the security level for internet sites and intranet sites is set to [High], it is necessary to add the IP address of the camera to the list of trusted sites.

Note

- Set the camera IP address with the Camera Management Tool (P. 40).

1 Click [Network and Internet] > [Internet Options] in [Control Panel].

2 Click the [Security] tab.

3 Click [Trusted sites] > [Sites].

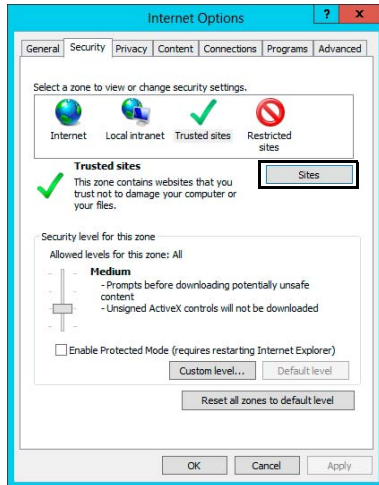

The [Trusted sites] dialog box is displayed.

4 Enter the IP address of the camera under [Add this website to the zone], then click [Add].

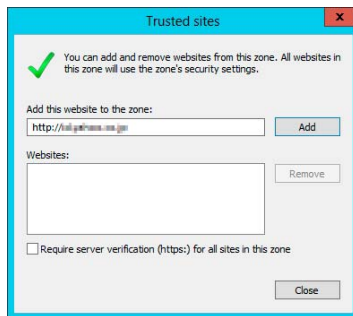

Note

- Clear the [Require server verification (https:) for all sites in this zone] checkbox if it is selected. The camera's IP address will be added to the [Websites] list.

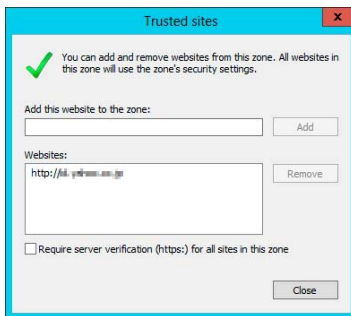

- You can add IP addresses for multiple cameras by using a wildcard (*) when entering the IP address. For example, if you enter "192.168.1.*", all cameras that share the "192.168.1" portion of the address will be added as trusted sites.

Sound Settings for Using the Audio Functions

R13 R11 M50 H65x M641 H761 H751 M741

In Windows Server, the sound function is disabled by default.

To use audio functions with the viewer, follow the steps below to enable the sound function.

1 Open [Control Panel] and click [Hardware].

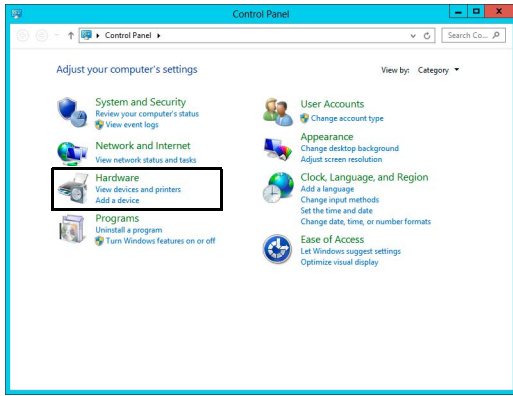

2 Click [Sound].

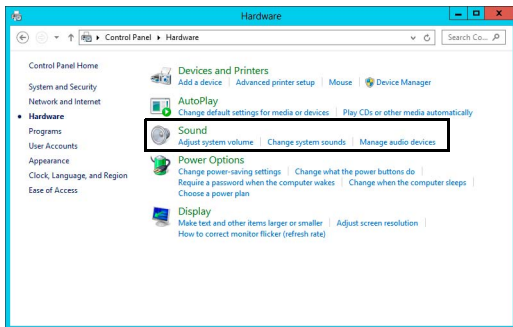

The [Audio Service Not Running] dialog box is displayed.

3 Click [Yes].

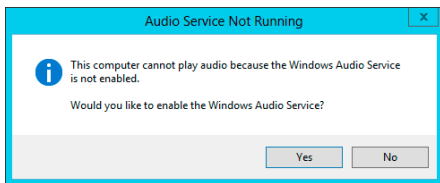

The [Sound] dialog box is displayed.

4 Click the [Playback] tab to confirm that an audio device has been installed.

If no audio device is installed, refer to your computer manual.

Configuring Initial Camera Settings

To use a camera, it is necessary to first set the administrator account for the camera, then configure the network settings, and then connect the camera and computer via the network. Use the Camera Management Tool to configure these settings. This section describes the procedure for configuring the initial settings for a camera with the factory default settings, such as the administrator account and the network settings using the Camera Management Tool.

Note

For details on using the Camera Management Tool, please refer to "Camera Management Tool User Manual".

Launching the Camera Management Tool

Launch the Camera Management Tool that was installed onto the computer from the setup CD-ROM.

- 1 Connect the camera and computer to the same network and turn on the power.
- 2 Double-click the [Camera Management Tool] icon on the desktop.



The Camera Management Tool launches and the main screen is displayed.

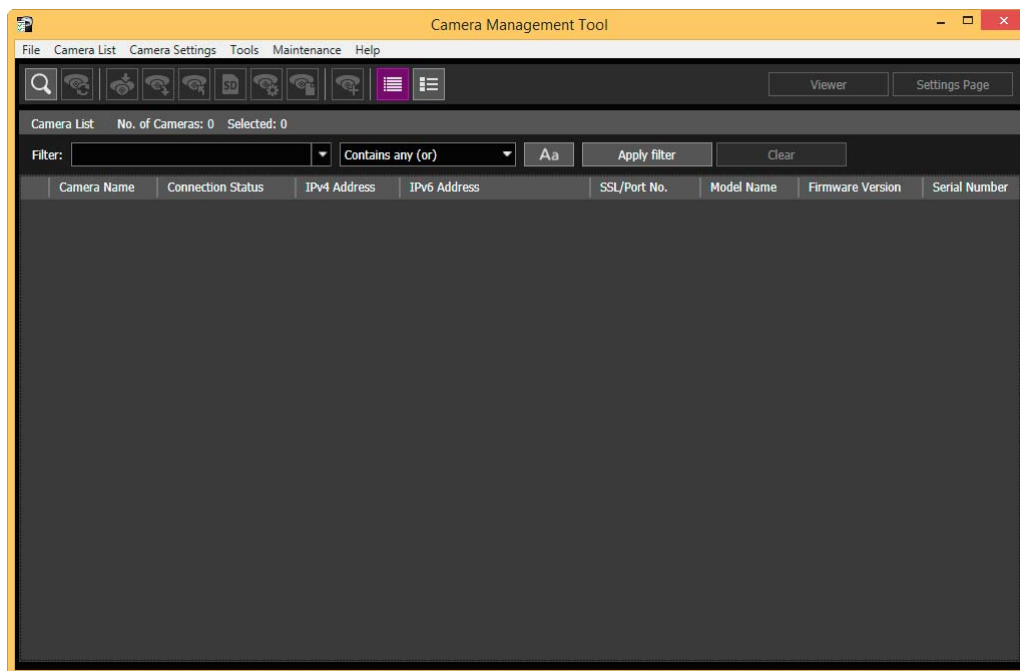

Searching for Cameras

Search for cameras connected to the same network as the computer in which the Camera Management Tool is installed, and add them to the camera list.

Note

R13 R12 M50 H65x H76x H751

Cameras with the factory default settings are configured to obtain an IP address from the DHCP server. Detect the camera using a DHCP environment or an IPv6 environment.

If you configure the settings using other environments, please refer to "Setting up the network without a DHCP server" (P. 41).

- 1 Click the [Search Cameras] icon.

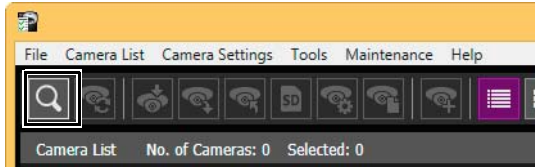

The [Search Cameras] dialog box is displayed.

- 2 Search for a Camera.

Click [Search].

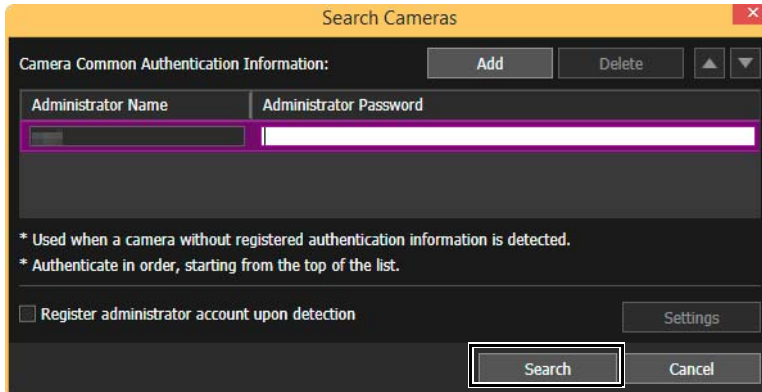

Detected cameras will be displayed in the camera list.

When a dialog indicating that a camera requiring an administrator to be registered has been found, click [OK].



Note

If a camera is not detected, even though it is connected to the same network, click again to perform detection.

■ Registering the Administrator Account to the Admin Required Camera

Register the administrator account for cameras with [Admin Required] displayed for [Connection Status].

- 1 Select a camera in the camera list and click the [Camera Settings] > [Register Administrator Account]. Alternatively, double-click [Admin Required] for [Connection Status].

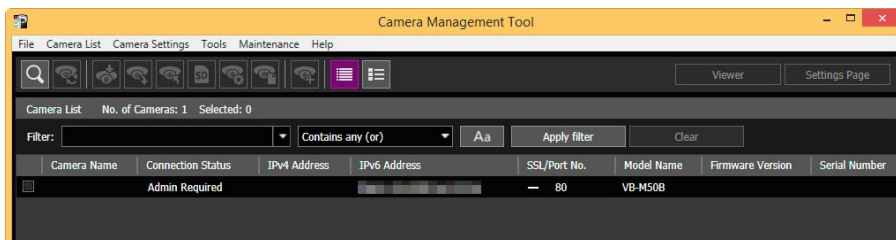

The [Register Administrator Account] dialog box is displayed.

2 Set the Administrator Name and Administrator Password.

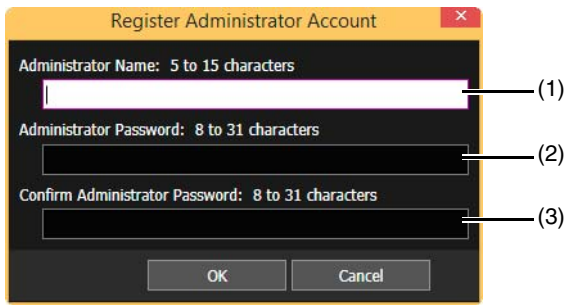

The dialog box titled "Register Administrator Account" contains three input fields and two buttons. The first field is for the Administrator Name (5 to 15 characters), the second for the Administrator Password (8 to 31 characters), and the third for the Confirm Administrator Password (8 to 31 characters). The OK and Cancel buttons are at the bottom.

- (1) [Administrator Name]
Enter the administrator name using only alphanumeric characters, hyphens, and underscores.
- (2) [Administrator Password]
Enter the administrator password.
- (3) [Confirm Administrator Password]
Enter the administrator password again for confirmation.

3 Click [OK].

A dialog confirming whether you want to reboot the camera is displayed.

Click [OK] to reboot the camera.

[Connection Status] will change to [Connectable] after the camera is rebooted.

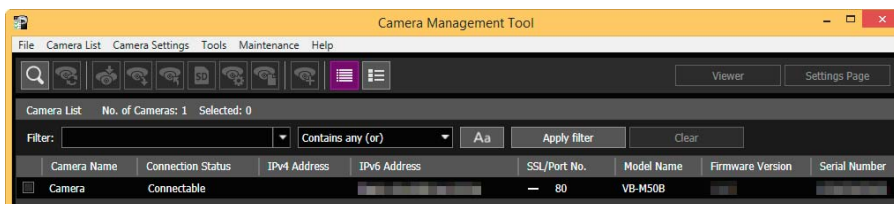

Changing the Administrator Account Settings

Select a camera in the camera list, click [Admin Account] in [Camera settings] > [Basic Camera Settings], and change the administrator name or password.

Important

To ensure high system security, change the administrator password periodically. Make sure to remember the new password.

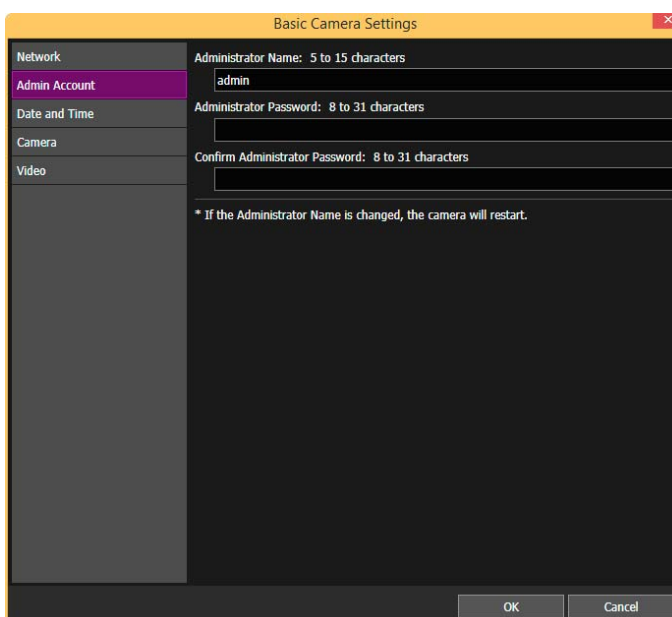

The dialog box titled "Basic Camera Settings" shows the Admin Account section. The Administrator Name is set to "admin". The Administrator Password and Confirm Administrator Password fields are empty. A note at the bottom states: "* If the Administrator Name is changed, the camera will restart." The OK and Cancel buttons are at the bottom.

Setting up Networks

Configure the network settings of the camera.

Select the camera in the camera list, click [Network] in [Camera Settings] > [Basic Camera Settings], and configure the settings.

The Camera Management Tool also enables you to select multiple cameras from the camera list to configure.

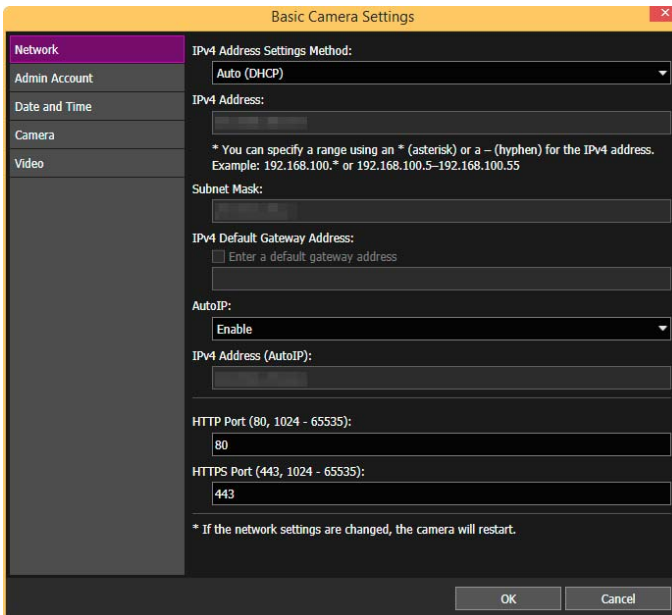

Checking the Video

After configuring the initial settings of the camera, access the camera to check whether video is displayed correctly.

- 1 Launch the Camera Management Tool (P. 37)
- 2 Select the camera to open the Viewer in the camera list.
- 3 Click [Viewer].

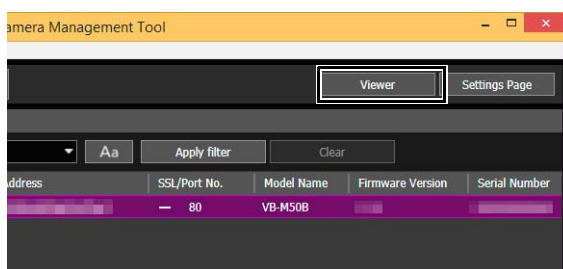

The authentication screen for the Viewer is displayed (P. 51).

- 4 Enter the administrator name and administrator password (P. 38), and click [OK].
The web browser starts and the Camera Viewer is displayed.

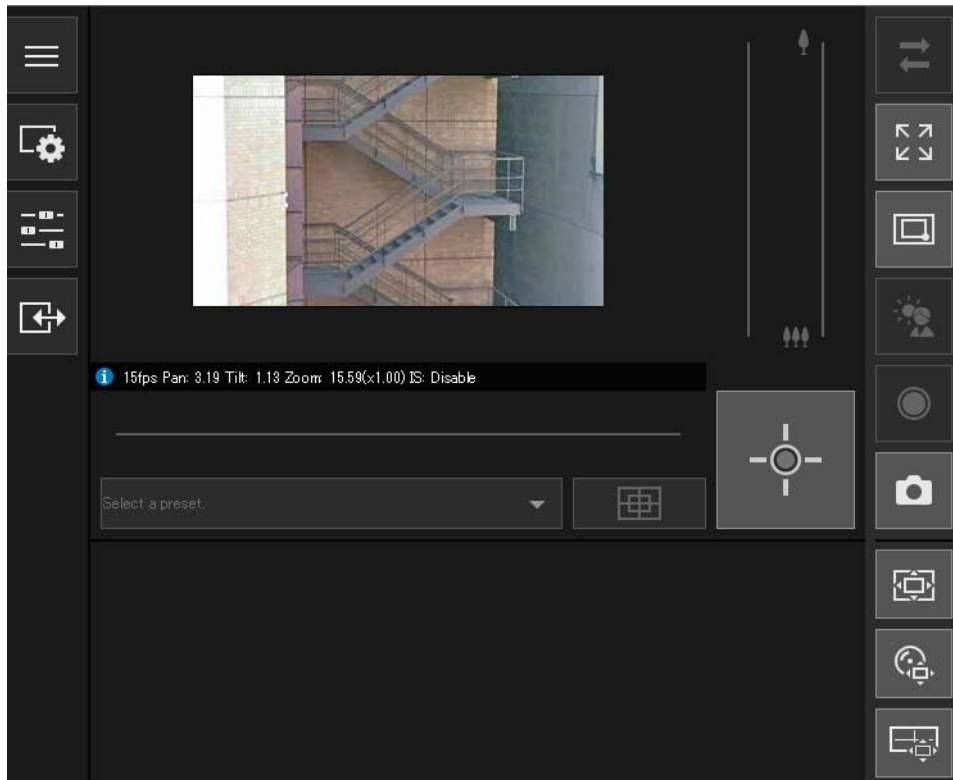

Note

The web browser only starts when [Connectable] or [Connectable (error)] is displayed for [Connection Status].

Setting up the network without a DHCP server

R13 R12 M50 H65x H76x H751

Cameras with the factory default settings are configured to obtain an IP address from the DHCP server. However, you can access a camera connected to a network environment without a response from the DHCP server by entering a specific IP address (192.168.100.1).

Important

- You can only access a camera 30 seconds after connecting the camera to the network environment without a response from the DHCP server using the 192.168.100.1 IP address.
- If there is a response from the DHCP server after 30 seconds has elapsed, the camera switches to the address assigned by the DHCP server.
- When accessing a camera by entering 192.168.100.1 in a web browser, set the computer to an IP address with the same subnet (255.255.255.0).
- If multiple cameras with the factory default settings exist on the same network, the cameras cannot be accessed.

- 1 Launch the web browser.
- 2 Enter 192.168.100.1, and press the Enter key.

The [Default Settings] top page will be displayed.

3 Enter the administrator name and administrator password, and click [Apply].

After the camera reboots, the Setting Page is displayed and you can configure the settings.

Chapter 3

Setting the Camera Angle

H651 M64x H751 M74x

After installing the camera, set the camera angle while checking the video displayed on the Setting Page.

Flow for the Setting of the Camera Angle

Adjust the camera angle when installing the camera or after changing the installation location.
The camera angle settings are configured by accessing the Setting Page (P. 86).

Important **H651 M64x**

[Camera] > [Camera Angle] on the Setting Page is for camera installation adjustment and is not intended for regular use. It may damage the camera if used frequently.

Step 1 Configuring the Camera Before Setting the Camera Angle

Set the digital zoom, image stabilizer, and image flip, which affect the camera angle.

[Digital Zoom] (P. 107) and [Image Stabilizer] (P. 108) in [Camera] > [Camera] > [Camera Control] on the Setting Page.

[Video Flip] (P. 110) in [Camera] > [Camera] > [Installation Conditions] on the Setting Page.

Step 2 Setting the Camera Angle and Focus

H651 M64x

Sets pan, tilt, zoom, rotation and focus.

[Camera] > [Camera Angle] (P. 45) on the Setting Page.

H751 M74x

Sets zoom.

[Camera] > [Initial Settings] (P. 112) on the Setting Page.

Select [Camera] > [Camera Angle] on the Setting Page to set pan, tilt, zoom, rotation and focus.

Important

- When starting to set the camera angle, the Viewers and recording software connected to the camera are disconnected.
- Connections to a single camera are limited to 30 minutes. Since the camera is automatically disconnected after 30 minutes elapse, click the [Reconnect] button to reconnect to the camera if you have not finished setting the camera angle.
- Multiple computers cannot simultaneously connect to a single camera, using [Camera Angle].

Note

[Camera Angle] can be also launched from the Camera Management Tool. For details, please refer to "Camera Management Tool User Manual".

Camera Angle Screen Composition



- (1) **Video Display Area**
Camera video is displayed here.
- (2) **Control Assist Display**
Displays the available directions for the camera with dotted lines when performing pan/tilt operations.
- (3) **[Pan] Buttons**
Pan the camera.
- (4) **[Tilt] Buttons**
Tilt the camera.
- (5) **[Zoom] Buttons**
Zoom the camera.
- (6) **[Rotation] Buttons**
Rotate the camera.
- (7) **[Rotation] Slider**
Click on the slider or drag the slider to rotate the camera angle.
- (8) **[Reconnect] Buttons**
Reconnects to the camera. Can be operated when not connected to the camera.

(9) [Control Assist Correction]

If you click [Exec] when the control assistance display does not match the actual camera angle, an operation is performed which confirms the actual camera angle, and the position of the control assistance display is automatically corrected.

Correction takes approximately one minute.

(10) [Camera Settings]

Operate the focus.

(11) Digital Zoom Range

Displayed when [Digital Zoom] is set to [Enable] in [Camera] > [Camera] > [Camera Control] on the Setting Page.

(12) [Zoom] Slider

Click on the slider or drag the slider to zoom the camera.

(13) [Control Assist Display] Button

Switch whether to display control assist in the video display area.

(14) [Apply]

Click [Apply] to apply the changed settings.

(15) [Clear]

Click [Clear] to revert to the previous settings.

Setting the Camera Angle and Zoom

You can set the camera angle and zoom using the video display area or buttons.



Important

If you change the camera angle after configuring the intelligent function, privacy mask, preset, and ADSR, those settings must be configured again.

■ Configuring the Settings with the Operation Buttons and Sliders

Set the angle and zoom using the [Pan], [Tilt], [Zoom], and [Rotation] buttons.

These buttons operate while pressed and stop when released.



Pans left or right.



Tilts up or down.



Operate the zoom ratio (telephoto/wide-angle).

To operate with the [Zoom] slider, drag the slider to change the camera zoom ratio according to the position on the slider.

If you set [Digital Zoom] to [Enable] in [Camera] > [Camera] > [Camera Control] on the Setting Page, the digital zoom area (yellow) is displayed and digital zoom becomes available.

The higher the digital zoom ratio, the lower the video quality becomes.

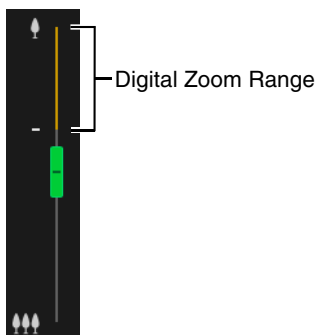

Controls the rotation.

To operate the camera angle using the [Rotation] slider, click the slider or drag the tab to adjust the camera to an angle where the subject in the video is horizontal.

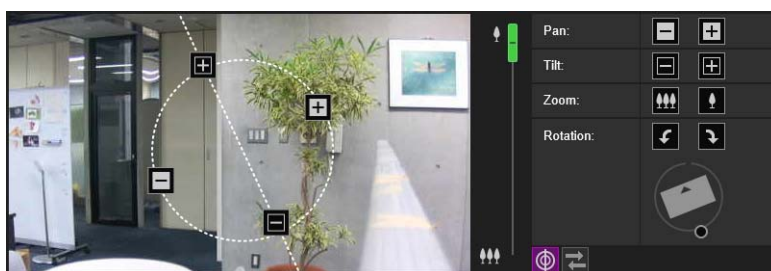
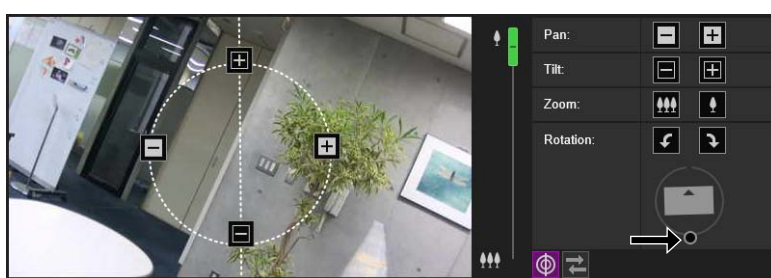

■ Setting Camera Angle by Clicking Video

If you click anywhere in the video display area, the camera angle will change to center on that location.

If you click outside the pan or tilt range, however, the camera angle will only change for the one which is within its range.

Note

If the camera moves differently than the intended operation, or if settings in the full range displayed by control assist cannot be made, control assist may be out of alignment with the actual camera angle. In this case, click [Exec] for [Control Assist Correction], and set the camera angle again.

Setting the Focus

You can automatically or manually focus on the subject, or fix the focus at infinity. When manually operating the focus, you can use the One-shot AF feature to focus on the subject.

For precautions, etc. regarding the focus, please refer to the “Important” and “Note” sections of [Camera] > [Initial Settings] > [Camera Settings] > [Focus] on the Setting Page (P. 114).

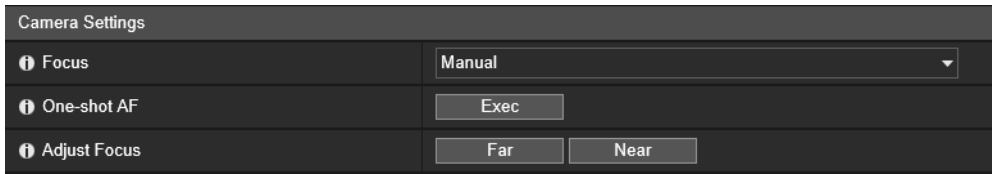

[Focus]

Selects the focus.

[Auto]

Automatically adjusts the focus.

[Manual]

You can click and hold the [Near] and [Far] buttons in [Adjust Focus] to adjust the focus in the near and far directions. When you click [Exec] in [One-shot AF], the camera will focus once using autofocus and then switch to manual mode.

[Fixed at Infinity]

You can set the focus so that it is fixed near infinity.

Note

If you click [Apply] to apply changed camera angle settings, the zoom and focus settings are also reflected in [Initial Settings].

Chapter 4

Camera Viewer

Use the web browser to access the Viewer in the camera to perform camera operations, view live video, and check the status of events.

Viewing Video with the Camera Viewer

You can start the Camera Viewer to switch users and check/configure the status of the camera as well as the video display.

Note

If you open another window or tab to access the camera while an authenticated web page is displayed, the authentication information of the displayed web page may be discarded.

In this case, enter the authentication information again.

Launching the Camera Viewer

You can enter the IP address set with the Camera Management Tool (P. 40) directly into a web browser to display the Setting Page of the camera, and start the Viewer from the Setting Page.

Note

For details on settings in the Camera Management Tool, please refer to “Camera Management Tool User Manual”.

- 1 Launch the web browser.
- 2 Enter the IP address, and press the Enter key.
The authentication screen for Setting Page will be displayed.
- 3 Enter the Administrator Name and Administrator Password (P. 38) and click [OK].



The Settings Menu is displayed.

Note

You can set [Basic] > [Viewer] > [General] > [Default Page] to [Display Viewer] in the setting menu to set the Viewer as the default page (P. 105).

- 4 Click [Viewer].

VB-M50B Settings Menu		Viewer	Language : English
Basic	Basic Settings for Using the Camera		
Camera	Camera control and parameter settings		
Video and Audio	Video and audio settings		
Server	Various Server Function Settings		
Video Record	Video Recording Settings (Uploads/E-mail Notifications, etc.)		
Event	Event Settings (Timer, etc.)		
Security	Access Restrictions and Security Communications Settings		
Memory Card	Memory card operations and settings		
Maintenance	Camera maintenance such as viewing logs or the current settings list, and rebooting the camera		
User Page	The settings pages that a user can add		

The authentication screen for the Viewer is displayed.

- 5 Enter the administrator name and administrator password (P. 38), and click [OK].

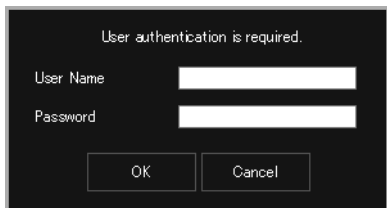

The Camera Viewer is displayed.

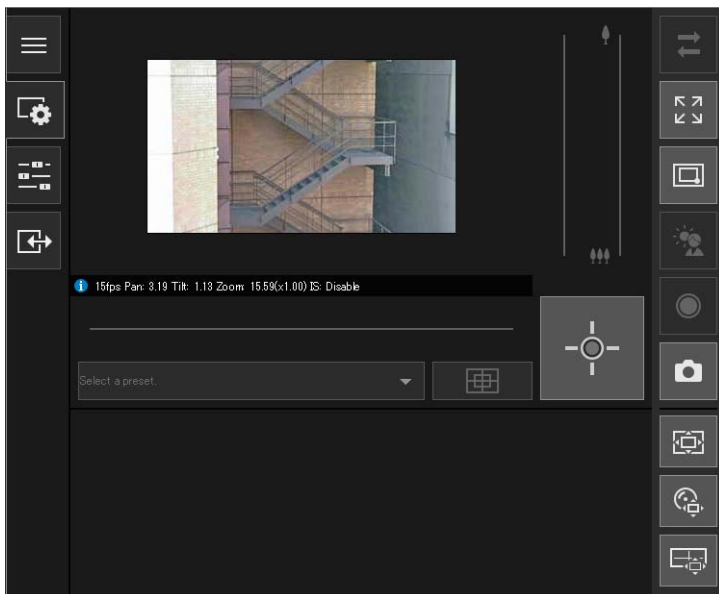

User Authentication

When you use the Viewer and the Setting page, an authentication screen is displayed, and you are prompted to enter a user name and password.

If you enter the wrong user name or password, you will not be able to connect to the camera. Enter the correct user name and password and connect to the camera.

When [Basic] > [Viewer] > [Viewer Settings] > [User Authentication] on the Setting Page is set to [Do not authenticate], the authentication screen is not displayed when connecting the Viewer.



Authentication screen for the Setting Page

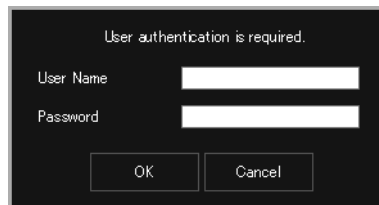

Authentication screen for the Viewer

The administrator name and administrator password are set using the Camera Management Tool (P. 38).

Important

- Change the administrator password periodically to enhance system security. Do not forget the new password.
- Restore factory default settings if you have forgotten the administrator account (P. 247). However, you will become unable to connect to the camera because the administrator account is also initialized. Use the Camera Management Tool to configure the initial settings (P. 37).
- It is strongly recommended that you clear the [Remember my credentials] checkbox when an authorized user shares a Viewer on the same computer.

Note

- Only administrators can connect to a camera using the Setting Page.
- When IE ESC (Internet Explorer Enhanced Security Configuration) is enabled in Windows Server, the blocked content dialog box may be displayed when attempting to access the Setting Page or the viewer. If this happens, please register the camera IP address as a trusted site (P. 34).

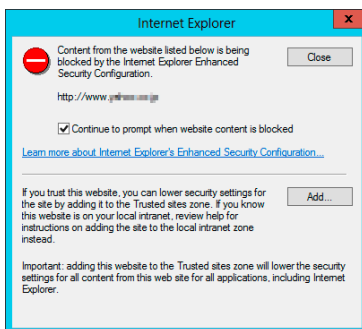

Switching to the Administrator or an Authorized User

If [Basic] > [Viewer] > [Viewer Settings] > [User Authentication] is set to [Do not authenticate] on the Setting Page, an authentication screen is not displayed when connecting to the Viewer, and you can use the Viewer as a guest user. Guest users cannot perform some operations with the Viewer, but you can also switch the user in order to use the Viewer as an administrator or authorized user.

- 1 Click the  [Main] button.

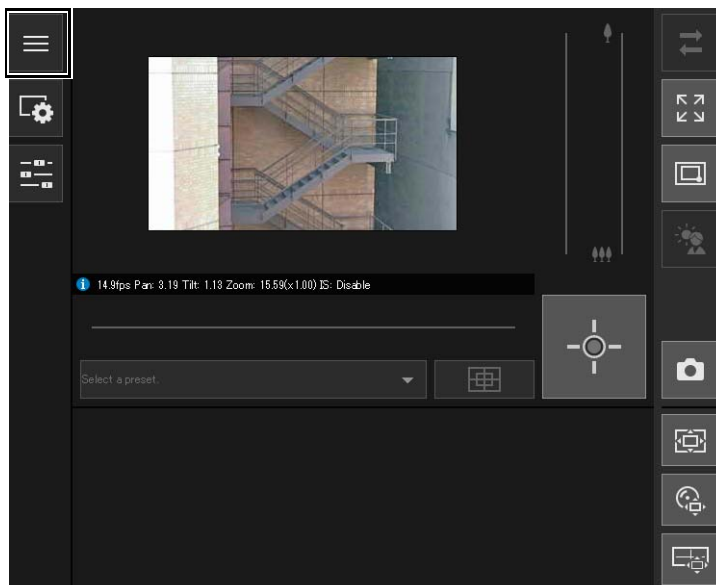

The [Main] menu will be displayed.

2 Click [Switch Users].

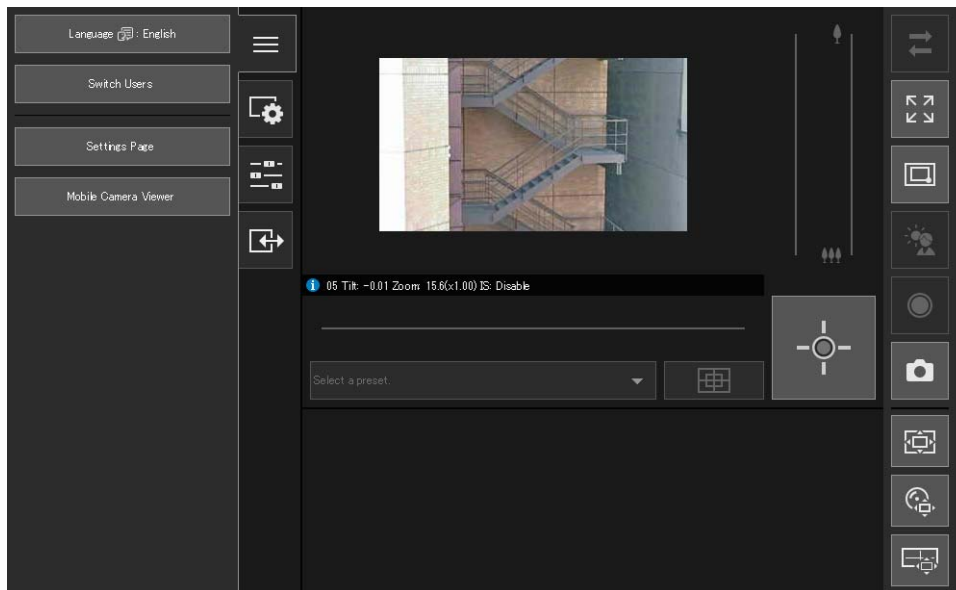

The user authentication window is displayed.

3 Enter a user name and password and click [OK].

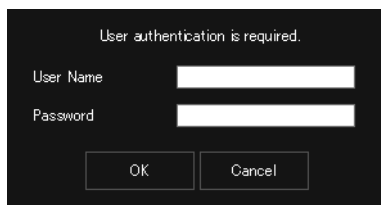

The Viewer for the user entered for user authentication is displayed.

Note

In environments without a proxy server, select [Network and Internet] > [Internet Options] > the [Connections] tab > [LAN settings], and clear the [Automatically detect settings] checkbox in [Control Panel].

Camera Viewer Access Restrictions

You can set authorized users, which require user authentication, and guest users, which do not require authentication.

The functions that each user can use in the Camera Viewer depend on the privileges assigned to the user (P. 99).

Administrator:

The user assigned all privileges.

Access the Viewer using the administrator name and password registered for the administrator account (P. 38).

The administrator can disable all the privileges of an authorized user or a guest user, and completely prohibit authorized users and guest users from accessing the camera.

Authorized user:

An authorized user has higher privileges than a guest user.

It is necessary to register the user name and password (P. 98).

Guest user:

This user can only use a limited set of functions.

Can access the Viewer without performing user authentication.

The four types of privileges for using the Viewers are privileged camera control, camera control, video distribution and audio distribution.

The scope of each privilege and whether it can be granted to a user is shown below.

Privilege	Privileged Camera Control	Camera Control	Video Distribution	Audio Distribution
Scope of Privilege	Can perform the most operations after the administrator.	Can perform some Viewer operations.	View video with the Viewer	Receive audio with the Viewer
Grant to Authorized Users	Yes	Yes	Yes	Yes
Grant to Guest Users	No	Yes	Yes	Yes

If an item in [Privileged Camera Control], [Camera Control], or [Video Distribution] is set to [Enable], the items above and to the right of that item are also set to [Enable]. If an item is set to [Disable], the items below and to the left of that item are also set to [Disable].

In the rows, more powerful privileges are on the left and less powerful privileges are on the right. However, audio distribution can be set separately.

In the columns, authorized users have higher privileges than guest users.



Important

- Multiple computers cannot connect to a single camera at the same time using the same administrator account. An authorized user or a guest user can connect to the camera from multiple computers at the same time. However, when controlling the camera, authorized users are given priority of the camera control, and guest users are placed in a queue.
- [Basic] > [Viewer] > [General] > [Default Page] must be set to [Display Viewer] to enable authorized users and guest users to connect to the camera.



Note

- With the factory default settings, authorized users are assigned privileges for camera control.
- With the factory default settings, guest users are assigned privileges for camera control, video distribution, and audio distribution.

Camera Viewer Screen

The privileges required for operating the Viewer are indicated with the following symbols.

★	Administrator Privileges
●	Privileged Camera Control or higher privileges
■	Camera Control or higher privileges
No Symbol	Video Distribution or higher privileges
○	Audio Distribution privileges

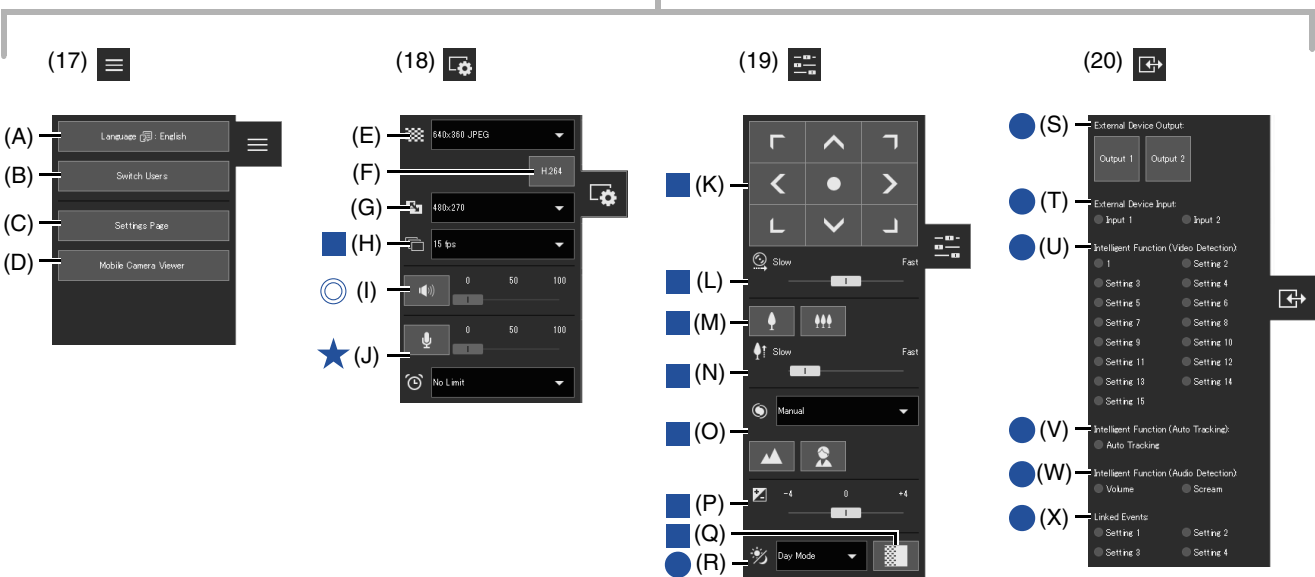
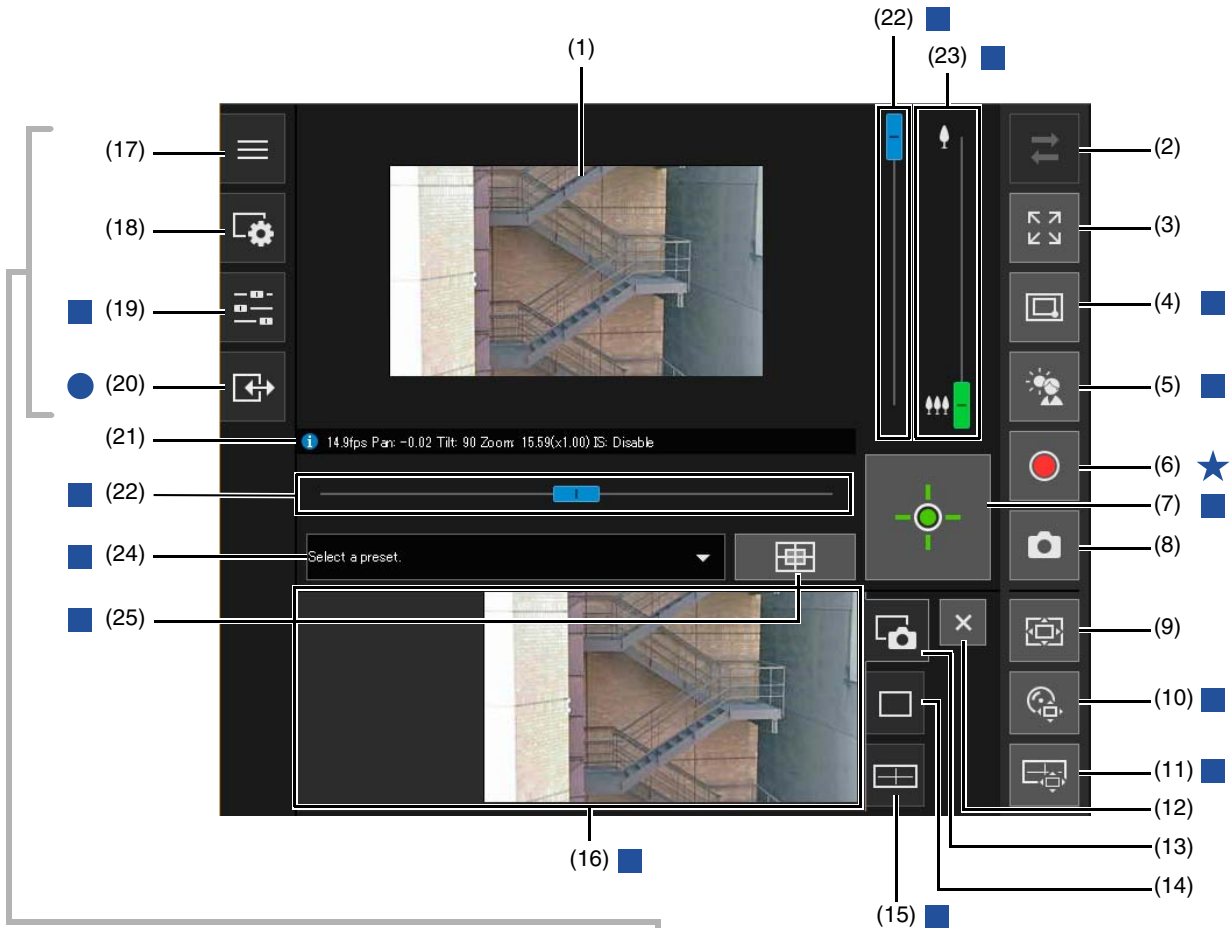

- (1) **Video Display Area**
Displays video received from the camera.
- (2)  **[Reconnect] Button**
Reconnects to the camera. Can be operated when the Viewer is not connected to the camera.
- (3)  **[Full Screen Mode] Button**
Video is displayed in full screen mode (P. 62).
- (4)  **[Switch Area Zoom/Drag to Move] Button** **R1x** **M50**
Switch between Area Zoom and Drag to Move functions for dragging in the video display area (P. 67).
- (5)  **[BLC] (Back Light Compensation) Button**
Turns on/off backlight compensation. This control is effective when the video is dark due to backlight (P. 71).
- (6)  **[Memory Card Recording] Button**
Start and stop video recording to a memory card (P. 78).
- (7)  **[Obtain/Release Camera Control Privileges] Button**
Obtain and release the camera control privileges (P. 65).
- (8)  **[Snapshot] Button**
Open the snapshot panel and display a still image of the moment you clicked the button in the control display area (P. 77).
- (9)  **[Viewer PTZ] Button**
Starts/stops the Viewer PTZ. When started, the Viewer PTZ panel is displayed in the control display area (P. 73).
- (10)  **[Digital PTZ] Button** **M50** **H65x** **M64x** **H76x** **H751** **M74x**
Starts/stops the Digital PTZ. When started, the Digital PTZ panel is displayed in the control display area (P. 74).
- (11)  **[Panorama Display] Button** **R1x** **M50**
Displays the panorama display panel in the control display area (P. 69).
- (12)  **[Close] Button**
Closes the panels displayed in the control display area.
- (13)  **Snapshot Tab**
Click this to switch the control display area to the snapshot panel (P. 77).
- (14)  **Viewer PTZ/Digital PTZ Tab**
Click this to switch the control display area to the Viewer PTZ/Digital PTZ panel (P. 73).
- (15)  **Panorama Display Tab** **R1x** **M50**
Click this to switch the control display area to the panorama display panel (P. 69).
- (16) **Control Display Area**
Click (13), (14), or (15) to display the snapshot panel, Viewer PTZ/Digital PTZ panel, or panorama display panel.

(17)  [Main] Menu

Switches the language or user, and switches the Setting Page or Mobile Camera Viewer.

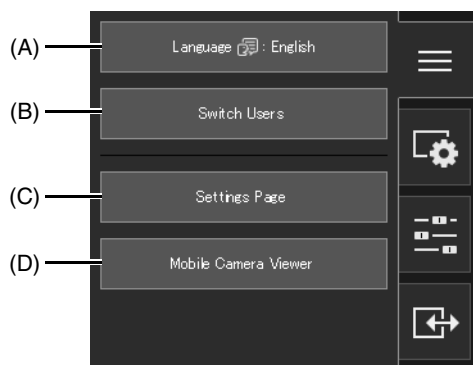

(A) [Language] Button

Switches the display language.

(B) [Switch Users]

Use this to log in as an administrator or authorized user (P. 52).

(C) [Settings Page]

The screen switches to the Setting Page (P. 86).

(D) [Mobile Camera Viewer]

Switches the connection to the Mobile Camera Viewer. For details on Mobile Camera Viewer, please refer to “Mobile Camera Viewer Operation Guide”.

(18)  [Video and Audio] Menu

Configures the video display size and audio transmission/reception of the Viewer.

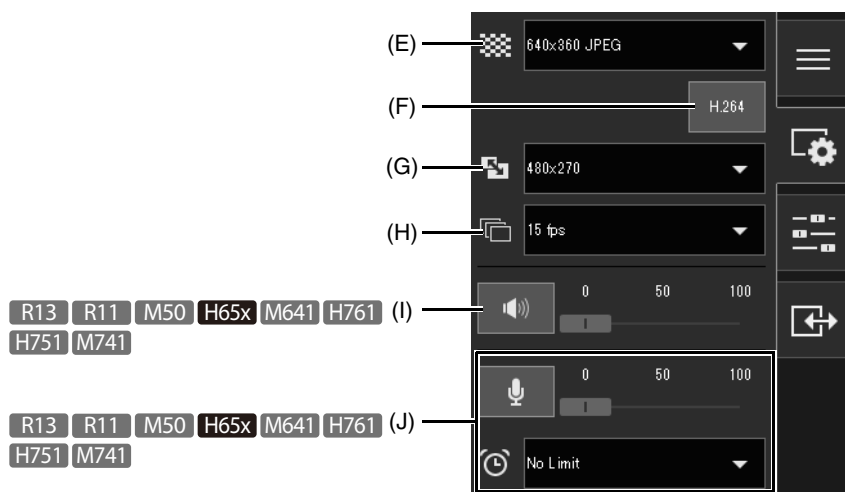

(E) Video Size

Select the video reception size and video format from the camera (P. 61).

(F) H.264 Reception

Selects whether to enable or disable H.264 video reception (P. 61).

For guest users, [H.264] is displayed if [Enable] is set in [Basic] > [Viewer] > [Viewer Settings] > [H.264 for Guest Users] on the Setting Page (P. 106).

(G) Display Size

Select the video display size for the screen (P. 61).

(H) Maximum Frame Rate

Select the maximum frame rate for JPEG video (P. 62).

(I) Audio Reception R13 R11 M50 H65x M641 H761 H751 M741

Start/stop audio reception from the camera and set the volume (P. 80).



(J) Audio Transmission R13 R11 M50 H65x M641 H761 H751 M741

Start/stop audio transmission from the camera, and set the volume and transmission time (P. 80).

(19)  [Camera Operation] Menu

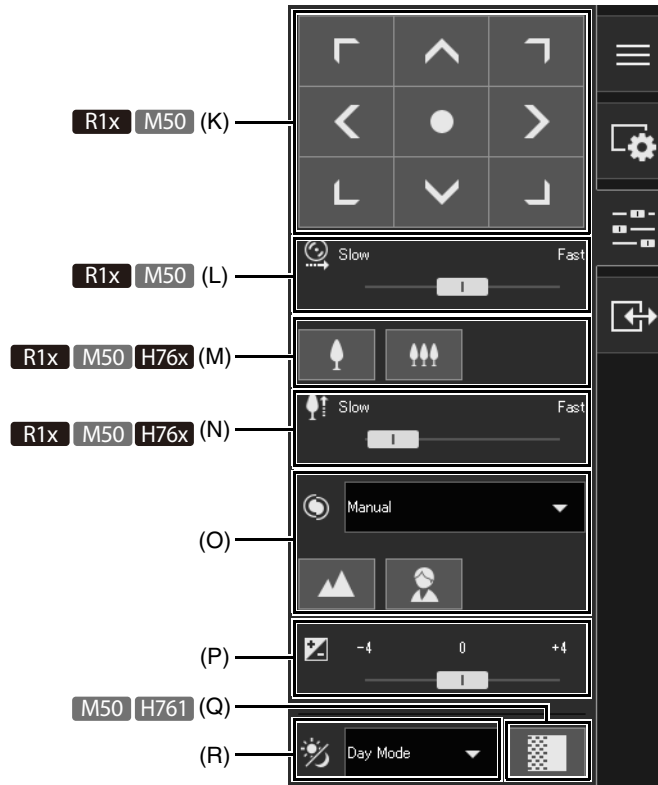
Sets the pan/tilt/zoom, focus, exposure, and day/night switch of the camera.



- (K) **Pan/Tilt** **R1x** **M50**
Operate a button to move the angle in the direction of the arrow (P. 69).
- (L) **Pan/Tilt Speed** **R1x** **M50**
Select the operating speed for the pan/tilt buttons (P. 69).
- (M) **Zoom** **R1x** **M50** **H76x**
Operate a button to  zoom in and  zoom out (P. 69).
- (N) **Zoom Speed** **R1x** **M50** **H76x**
Select the operation speed for the zoom button (P. 69).
- (O) **Focus**
Sets the camera to focus on the subject (P. 70).
- (P) **Exposure Compensation**
Corrects the exposure according to the brightness of the subject (P. 70).
- (Q) **Clear IR Mode** **M50** **H761**
Selects whether to enable/disable the clear IR mode that reduces shade and heat shimmer in far backgrounds (P. 71).
- (R) **Day/Night**
Set a capture mode suited to the brightness of the camera installation environment (P. 71).

(20)  [Event and Input/Output] Menu

Enables you to check the output operations and input status of an external device, the detection status of the intelligent function and the status of linked events.

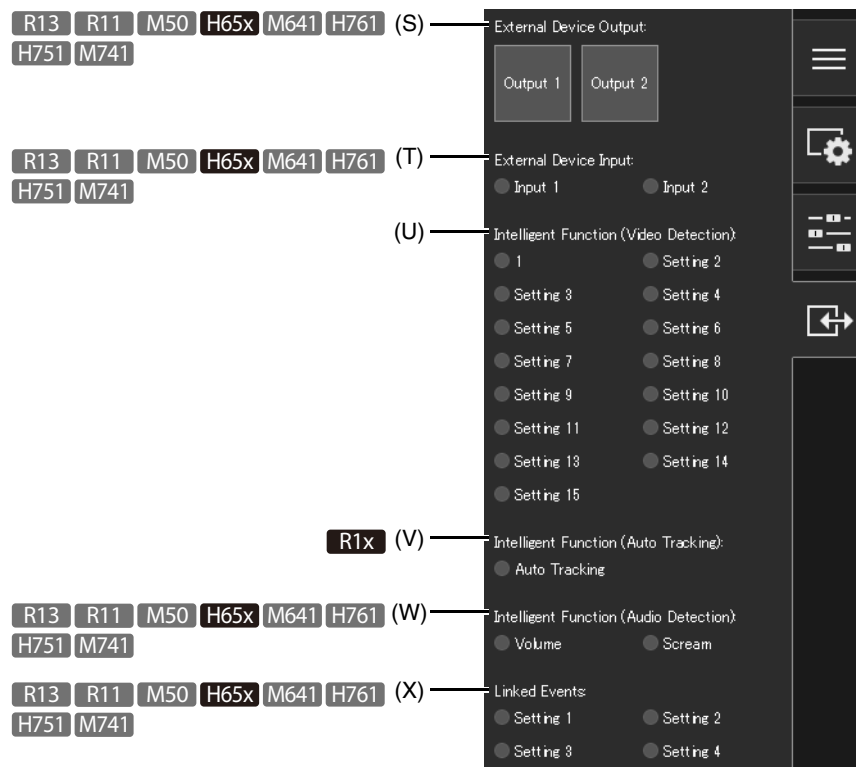

(S) External Device Output **R13 R11 M50 H65x M641 H761 H751 M741**

Use external device output (P. 82).

(T) External Device Input **R13 R11 M50 H65x M641 H761 H751 M741**

Displays the status of the external device input signal for each input source (P. 82).

(U) Intelligent Function (Video Detection)

Displays the status of video detection by the intelligent function for each detection setting number (P. 82).

(V) Intelligent Function (Auto Tracking) **R1x**

The status of Auto Tracking by the Intelligent Function is displayed (P. 83).

(W) Intelligent Function (Audio Detection) **R13 R11 M50 H65x M641 H761 H751 M741**

Displays the status of [Volume Detection] or [Scream Detection] (P. 83).

(X) Linked Events **R13 R11 M50 H65x M641 H761 H751 M741**

Displays the status of linked events (P. 83).

(21) Information Display

Information, warning and error messages are displayed (P. 60).

(22) Pan/Tilt Slider **R1x M50 H65x M64x H751 M74x**

Drag the sliders to pan (horizontally) or tilt (vertically) the camera (P. 66).

(23) Zoom Slider

Turn the knob to operate the zoom in (telephoto)/zoom out (wide-angle) function of the camera (P. 66).

(24) Preset Selection Menu

Selects a preset registered in the camera in advance (P. 72).

(25) [Home Position] Button

Move the camera angle to the home position (P. 72).

Checking Information

Information, such as the frame rate, camera pan/tilt/zoom values and descriptions of each function, is displayed in the Information Display.

Warning and error messages will also be displayed here if there are problems with camera operations or systems.

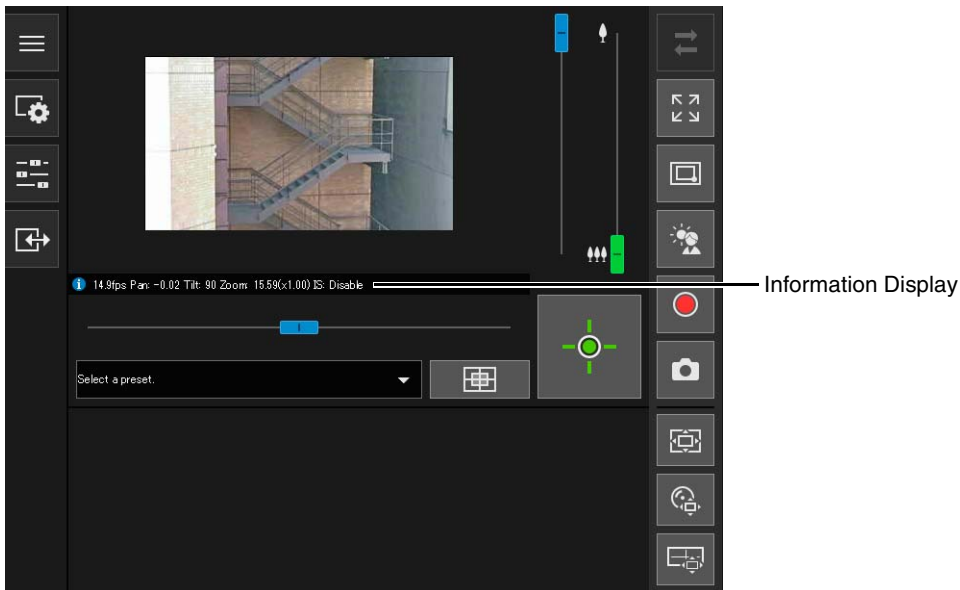

For details on the information displayed, please refer to “List of Viewer Messages” (P. 245).

Important

- When [Camera] > [Camera] > [Camera Control] > [Image Stabilizer] (P. 108) is enabled, the actual angle of view of the video will be smaller than the pan/tilt/zoom values shown in the Information Display.

R11 R10

- The actual displayed angle of view will be smaller than that shown in the panorama display panel (P. 69).

Changing the Reception Video Size and Display Screen Size

You can set the size and format of the video received from the camera and the size of the display screen on the computer.

Changing the Reception Video Size/Format and Display Screen Size

Open the  [Video and Audio] menu and configure the video received from the camera.

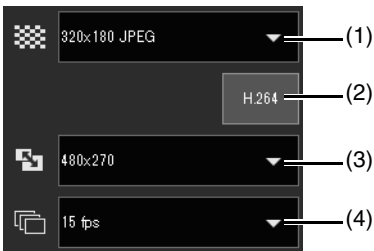

(1) Video Size Setting

Select the size and format of video received from the camera.

The sizes that can be selected depend on the setting in [Basic] > [Video] > [All Videos] > [Video Size Set] on the Setting Page (P. 102).

[Video Size Set] Setting	Selectable Video Size	
	JPEG	H.264*1
1920 x 1080 / 960 x 540 / 480 x 270*2	480 x 270 960 x 540 1920 x 1080	<ul style="list-style-type: none"> The sizes set with [Video Size] in [Basic] > [Video] > [H.264(1)] or [H.264(2)] on the Setting Page (P. 103), determine the sizes displayed in the menu. When [H.264(2)] is set to [Enable] in [Basic] > [Video] > [H.264(2)] on the Setting Page (P. 104), both the [H.264(1)] and [H.264(2)] video sizes are displayed in the menu.
1280 x 720 / 640 x 360 / 320 x 180	320 x 180 640 x 360 1280 x 720	
1280 x 960 / 640 x 480 / 320 x 240	320 x 240 640 x 480 1280 x 960	

*1 If you enable [H.264] (make it purple), the H.264 video size is added to the menu.

*2 [1920 x 1080 / 960 x 540 / 480 x 270] cannot be set for [Video Size Set] (P. 102). **R11 R10 M50 M64x M74x**

(2) H.264

Enable this (make it purple) to receive the H.264 video.

If you click this when it is disabled (gray), the [CANON SOFTWARE LICENSE AGREEMENT] dialog box is displayed. Click [Yes] to accept the terms of the license agreement. The decoder is downloaded from the camera, enabling H.264 video reception. The [CANON SOFTWARE LICENSE AGREEMENT] dialog box is not displayed for a guest user.

(3) Display Size Setting

The sizes that can be configured depend on the setting in [Basic] > [Video] > [All Videos] > [Video Size Set] on the Setting Page (P. 102).

[Video Size Set] Setting	Selectable Screen Size	Remarks
1920 x 1080 / 960 x 540 / 480 x 270*	Actual Pixels 480 x 270 960 x 540 1920 x 1080 Fit to Window	[Actual Pixels] displays the video at the size at which it is being captured. [Fit to Window] displays the video at the maximum size possible in the web browser window.
1280 x 720 / 640 x 360 / 320 x 180	Actual Pixels 480 x 270 640 x 360 1280 x 720 Fit to Window	
1280 x 960 / 640 x 480 / 320 x 240	Actual Pixels 480 x 360 640 x 480 1280 x 960 Fit to Window	

* [1920 x 1080 / 960 x 540 / 480 x 270] cannot be set for [Video Size Set] (P. 102). **R11 R10 M50 M64x M74x**

(4) Max. Frame Rate (JPEG)

You can select the maximum frame rate for JPEG video.

The setting is not selectable when displaying H.264 video in the video display area.

Displaying in Full Screen Mode

You can display the video display area in full screen mode by clicking the [Full Screen Mode] button in the upper right of the Viewer.

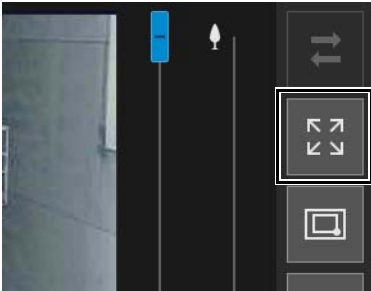

Menus

When the full screen view is used, the menu panels required for controlling the camera are displayed on the bottom of the screen, as with the Camera Viewer screen.

The privileges required for operating the menu panel are indicated with the following symbols.

★	Administrator Privileges
●	Privileged Camera Control or higher privileges
■	Camera Control or higher privileges
No Symbol	Video Distribution or higher privileges
◎	Audio Distribution privileges

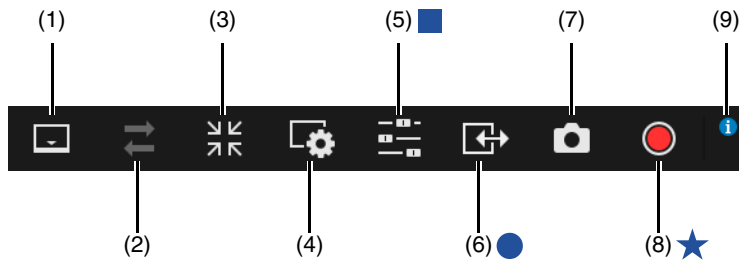

- (1) **Menu Area Display Switch Button**
Switches between displaying and hiding the menu bar.
- (2) **[Reconnect] Button**
Reconnects to the camera. Can be operated when the Viewer is not connected to the camera.
- (3) **Full Screen Mode Switch Button**
Returns the video display area to the regular view.
- (4) **[Video and Audio] Menu**
Configures the video display size and audio transmission/reception of the Viewer.



- (A) **Video Size**
Sets the reception video size from the camera (P. 61).
- (B) **H.264**
Selects whether to enable/disable H.264 video reception (P. 61).
- (C) **Maximum Frame Rate**
Selects the maximum frame rate for JPEG video (P. 61).
- (D) **Audio Reception** R13 R11 M50 H65x M641 H761 H751 M741
Plays/stops the received audio and sets the volume (P. 80).
- (E) **Audio Transmission** R13 R11 M50 H65x M641 H761 H751 M741
Plays/stops the transmitted audio and sets the volume and audio transmission time (P. 80).
- (5) **Camera Operation Menu**
Performs the basic settings and operations of the camera.

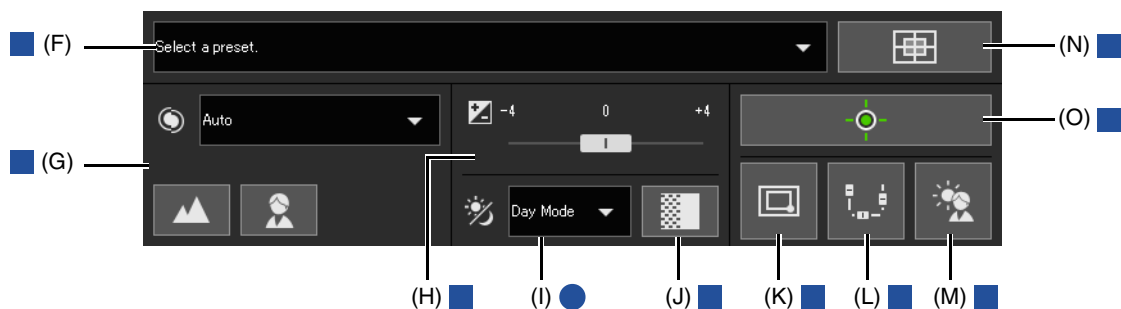

- (F) **Preset**
Selects a preset registered in the camera in advance (P. 72).
- (G) **Focus**
Sets the camera to focus on the subject (P. 70).
- (H) **Exposure Compensation**
Corrects the exposure according to the brightness of the subject (P. 70).

- (I) **Day/Night**
Set a capture mode suited to the brightness of the camera installation environment (P. 71).
- (J) **Clear IR Mode** **M50** **H761**
Selects whether to enable/disable the clear IR mode that reduces shade and heat shimmer in far backgrounds (P. 71).
- (K) **Switch Area Zoom/Drag to Move** **R1x** **M50**
Switch between Area Zoom and Drag to Move functions for dragging in the video display area (P. 67).
- (L) **Pan/Tilt/Zoom**
If you enable this button (make it purple), the pan/tilt/zoom sliders are displayed on the screen to perform operations.
The pan slider is displayed on the bottom of the screen, the tilt slider on the left edge of the screen, and the zoom slider on the right edge of the screen.
- (M) **BLC (Back Light Compensation)**
Turns on/off backlight compensation (P. 71).
- (N) **Home Position**
Move the camera angle to the home position (P. 72).
- (O) **Obtain/Release Camera Control Privileges**
Obtain and release the camera control privileges (P. 65).
- (6) **Event and Input/Output Menu** **R13** **R11** **M50** **H65x** **M641** **H761** **H751** **M741**
Use external device output (P. 82).

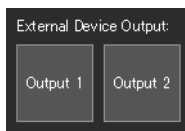

- (7) **Snapshot**
Displays the still image displayed when the button was clicked by opening the snapshot panel (P. 77).
- (8) **Memory Card Recording**
Start and stop video recording to a memory card (P. 78).
- (9) **Information Display**
Information, warning and error messages are displayed (P. 60).

Operating the Camera

This section describes the operations and configuration required for using the camera, such as obtaining camera control privileges, setting the angle and focus.

Important

It is necessary to obtain the camera control privileges to perform the operations and configuration as first described in this section.

Obtaining Camera Control Privileges

To use the camera, you must obtain control privileges with the Viewer.

If you have not yet obtained camera control privileges, click the [Obtain/Release Camera Control Privileges] button.

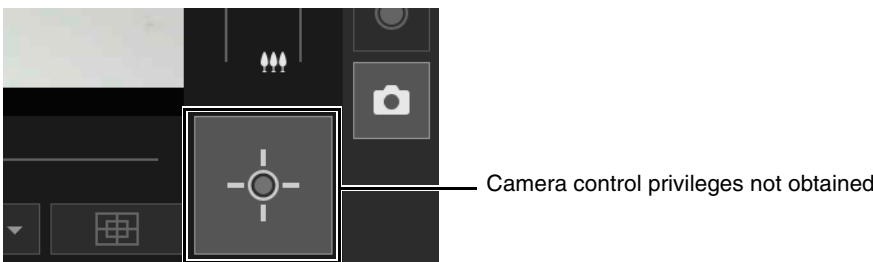



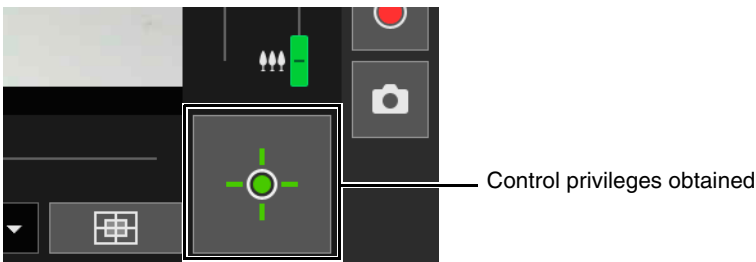

You will obtain control privileges and be able to use the buttons on the Viewer.

The center of the [Obtain/Release Camera Control Privileges] button turns green while you have control privileges.



■ Camera Control Privilege Status Indicator

Depending on the camera control privilege status, the [Obtain/Release Camera Control Privileges] button appearance changes as follows.

Appearance	Control Privilege Status	Explanation
	Control privileges not obtained	Camera control privileges have not been obtained.
	Waiting for control privileges	When a guest user is waiting to obtain camera control privileges, the remaining time is counted down.
	Control privileges obtained	Camera control privileges have been obtained.
	Control privileges obtained (remaining control time)	After a guest user has obtained camera control privileges, the time that the user can retain control privileges in priority over other guest users is counted down.

Important

- Multiple users cannot obtain control privileges simultaneously.
- The Obtain/Release Camera Control Privileges button is displayed for authorized users and guest users if [Camera Control] is selected in [Basic] > [User Management] > [User Authority] on the Setting Page.
- Administrators can take away camera control privileges from authorized users or guest users. Authorized users can also take away camera control privileges from guest users.
A user with lower privileges cannot obtain camera control privileges while a user with higher privileges has camera control privileges. Once finished, the administrator should always exit the Viewer or click the [Obtain/Release Camera Control Privileges] button to release the control privileges.

Using Pan/Tilt/Zoom

You can pan, tilt and zoom the camera to set the camera angle.

Note

- Camera operations using clicking and dragging, do not offer a high precision control of the camera.
- The administrator can operate the camera regardless of view restrictions. Authorized and guest users can only operate the camera within the restricted view. **R1x M50 H76x**

■ Clicking on the Video Display Area or Use the Sliders

Moving by Clicking on the Video Display Area

If you click in the video display area, the camera angle will change to center on the mouse pointer location. If the camera angle does not center on the desired location with a single click, repeat the operation.

Note

- Click operations are not available in the video display area while using the Viewer PTZ or Digital PTZ. **R1x M50**
- Click operations in the video display area become available after starting the Viewer PTZ or Digital PTZ. **H65x M64x H76x H751 M74x**

Moving Using the Sliders

Drag the pan and tilt sliders to pan and tilt the camera. **R1x M50 H65x M64x H751 M74x**

Drag the zoom slider to zoom the camera.

The slider can also move by clicking directly on the slider bar.



Note **H65x M64x H751 M74x**

Slider operations cannot be performed unless the Viewer PTZ or Digital PTZ is started.

Sliders Used for Digital Zoom and Enhanced Digital Zoom R1x M50 H76x

If you set [Camera] > [Camera] > [Camera Control] > [Digital Zoom] to [Enable] on the Setting Page (P. 107), the digital zoom range (orange) will be displayed on the zoom slider and you will be able to use digital zoom. Also, if you set [Camera] > [Camera] > [Camera Control] > [Enhanced Digital Zoom] to [Enable] on the Setting Page (P. 107), the enhanced digital zoom range (blue) is displayed on the zoom slider and enhanced digital zoom becomes available. Enhanced digital zoom performs digital zooming within a range where poor image quality is not apparent, according to the received video size.

Note

- The zoom magnification for enhanced digital zoom is limited to the video size set by the user with camera control privileges. Since other users also use digital zoom with the same zoom ratio, video deterioration may occur, depending on the received video size.
- If you perform a zoom in operation that passes the telephoto end of the enhanced digital zoom area when both the digital zoom area and enhanced digital zoom area exist, the camera temporarily stops at the telephoto end of the enhanced digital zoom area.
- The zoom ratio (digital zoom ratio) is displayed in the information display.
- With digital zoom, image quality is reduced as the zoom ratio increases.

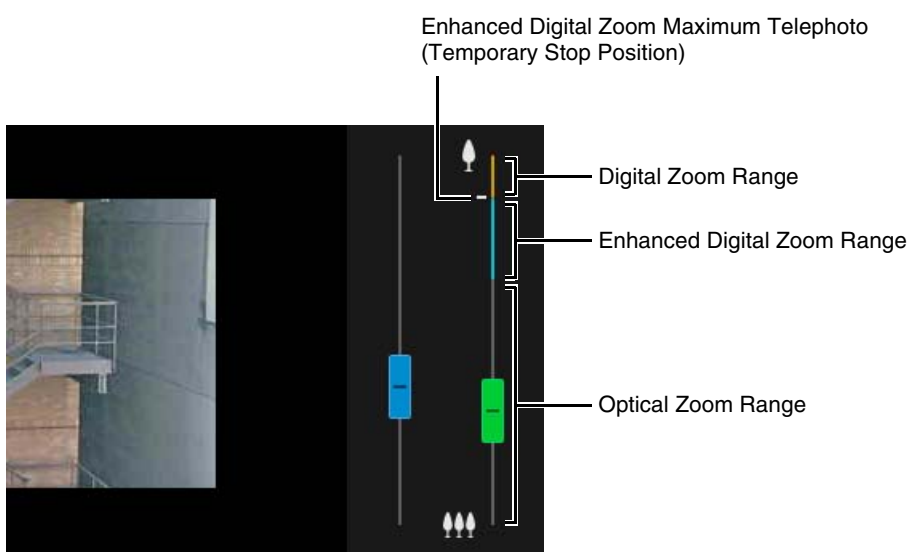

Using Area Zoom/Drag to Move

R1x M50

You can drag on the video display area to zoom in and out, and change the camera angle.

Note

You cannot use Area Zoom or Drag to Move when using Viewer PTZ or Digital PTZ.

Using Area Zoom to Zoom In and Out

- 1 Click the [Switch Area Zoom/Drag to Move] button to enter  (Area Zoom) mode.

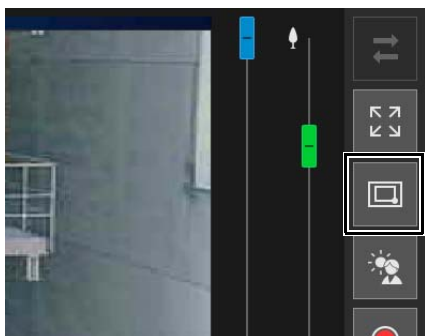



2 Drag out a frame in the video display area.

Drag left-to-right to define an area to zoom in on.

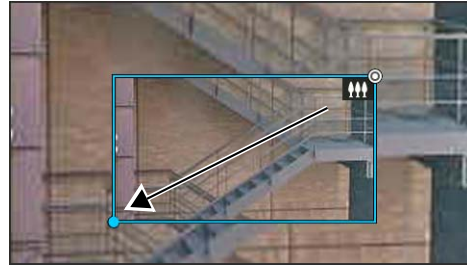
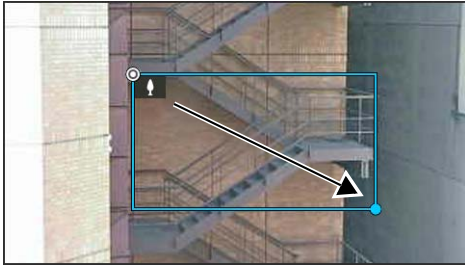
Drag right-to-left to draw out a frame in which will appear a preview of the video display area that will be zoomed out to.



When operating in Area Zoom mode, an icon (zoom in: ; zoom out: ) is displayed in the frame. To stop Area Zoom, right-click with the left mouse button held down, and the frame is displayed.

3 Release the mouse button.

When dragged left-to-right, the camera will zoom in until the area in the frame fills the video display area. When dragged right-to-left, the camera will zoom out, centered around the area in the frame.

Using Drag to Move to Change the Camera Angle

1 Click the [Switch Area Zoom/Drag to Move] button to enter (Drag to Move) mode.

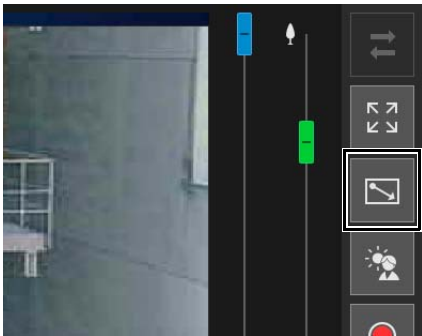

2 In the video display area, drag in the direction you would like to change the camera angle. An arrow will be displayed.

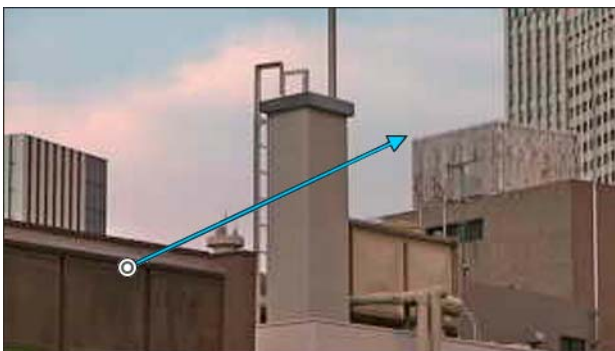

The camera angle will move in the direction of the arrow.

The maximum length of the arrow is half the width and height of the video display area, and movement speed increases with the length of the area.

Note

When using Drag to Move, the pan/tilt sliders will not move.

3 Release the mouse button.

The camera will stop.

Using [Pan/Tilt/Zoom] in the [Camera Control] Menu

R1x M50 H76x

Open the  [Camera Operation] menu and perform camera pan, tilt, and zoom operations.

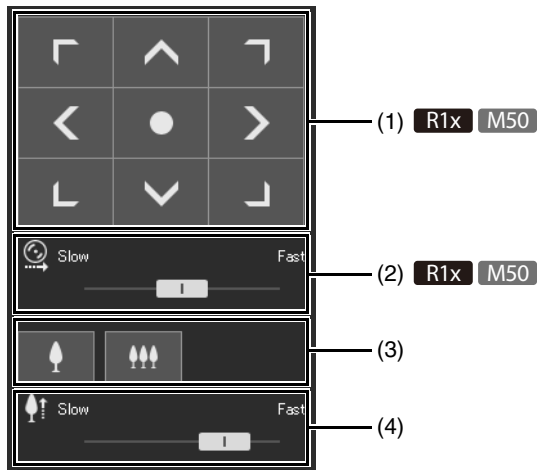



- (1) **[Pan/Tilt]** 

The camera angle will move in the direction of each arrow. Movement will continue while you hold the button down, and stop when you release it.

Click the center button to move the camera angle to the midpoint of the pan/tilt range of motion. However, if a view restriction is set (P. 128) and the midpoint is outside the restrict view area, the camera angle moves to the edge of the restrict view area.
- (2) **Pan/Tilt Speed** 

Set the operation speed by the [Pan/Tilt] button.
- (3) **[Zoom]**

Click the  (Zoom in) and  (Zoom out) buttons. Movement will continue while you hold the button down, and stop when you release it.
- (4) **Zoom Speed**

Set the operation speed by the [Zoom] button.

Note

Even if you change the pan/tilt speed or zoom speed setting, the speed of pan/tilt/zoom operations on the slider or panorama does not change.

Operating the Camera with the Panorama Display Panel

R1x M50

You can operate the camera using the frames within the panorama display panel.

To display a panorama image in the panorama display panel, you must create the image and save it to the camera (P. 123).

- 1 Click the [Panorama Display] button.



The [Panorama Display] panel is shown in the control display area.

2 Use the frame in the panorama display panel to pan/tilt/zoom the camera.

The frame indicates the area being captured by the current camera.

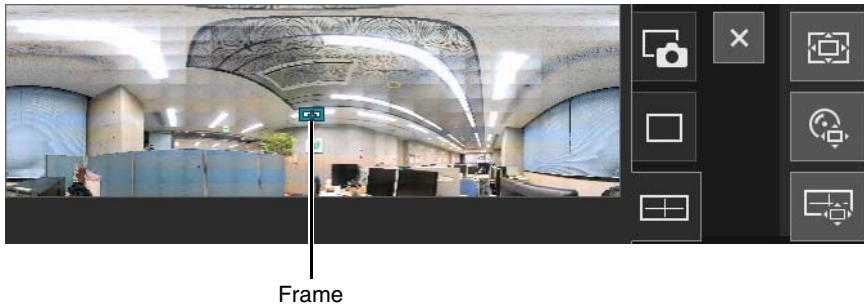

Move or Zoom by Dragging

Click inside the frame and drag it to pan and tilt the camera.

If you click and drag outside the frame, a new frame will be drawn. The camera will pan/tilt/zoom to capture the area in the frame.

If you drag an edge of the frame to change its size, the camera will zoom in or out to capture the area in the frame.

Move by Clicking

If you click outside the frame, the frame will move and center on that point, panning and tilting the camera.

Adjusting Video

Open the [Camera Operation] menu to operate focus, exposure compensation, clear IR mode and day/night function.

■ Focusing

Focus on the subject.

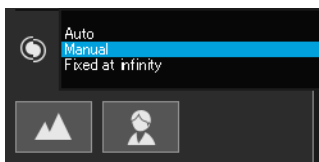

[Auto]

Focusing is performed automatically.

[Manual]

You can click and hold the (Near) and (Far) buttons to adjust the focus in the near and far directions.

[Fixed at infinity]

You can set the focus so that it is fixed near infinity.

Note

- For cautions on using Focus, see the "Important" section on P. 114.
- For information on the range of focus, please refer to the table on P. 114.

■ Setting the Exposure Compensation

Adjust the brightness of the video.

Move the slider to a negative value to make the video darker or a positive value to make the video lighter.

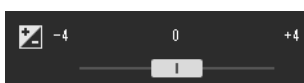

Important

- Cannot be set when [Exposure] is set to [Manual] on the Setting Page (P. 115).
- Cannot be set when [Smart Shade Control] is set to [Auto] on the Setting Page (P. 116).

■ Setting the Clear IR Mode

M50 H761

If you click the [Clear IR Mode] button to enable it (make it purple), the video becomes black and white, which reduces shade and heat shimmer in far backgrounds.



ON Status



ON Status (while camera control privileges are not obtained)



OFF Status

■ Switching Day/Night

Set the shooting mode according to the brightness of the installation environment of the camera.

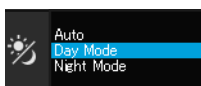

For details on this function, see [Day/Night] on “Setting Page” (P. 119).

Important

- Day/night can be set by the administrator and authorized users with privileged camera control.
- Day/night cannot be set when the clear IR mode is enabled (purple). M50 H761
- For cautions on using Day/Night, see the “Important” section on P. 119.

Using Backlight Compensation

Click [BLC] to brighten video that is dark due to backlight.

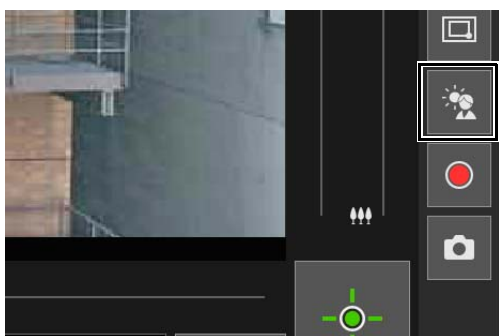

The back light compensation button becomes active (purple) while backlight compensation is being performed. Click the button again to cancel backlight compensation.

Important

- You cannot use the [BLC] button if [Smart Shade Control] is set to [Auto] on the Setting Page.
- You cannot use the [BLC] button if [Exposure] is set to [Manual] on the Setting Page.

Note

If bright areas are overexposed, use [Smart Shade Control] on the Setting Page.

Using Presets or the Home Position

It is possible to control the camera using a preset or home position registered to the camera in advance.

When you click the preset selection menu and select a preset from the list that is displayed, the camera will be set to the registered setting of the selected preset.

Clicking the [Home Position] button will set the camera to the registered setting of the home position.

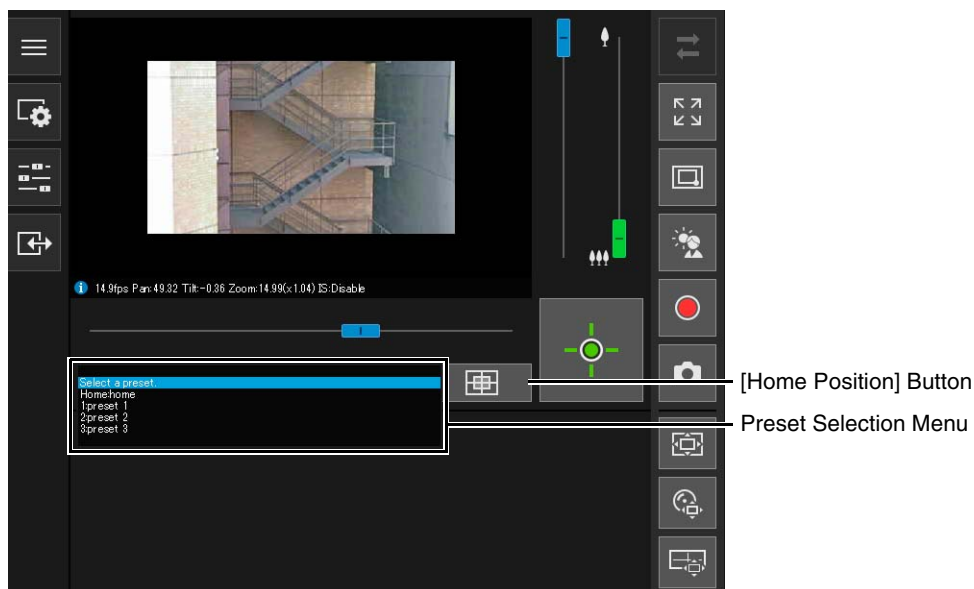

Note

Register preset/home positions in advance in [Camera] > [Preset] > [Register Preset] (P. 131) on the Setting Page. The registered preset is displayed in the preset selection menu.

Viewer PTZ and Digital PTZ

Viewer PTZ and Digital PTZ are both functions which allow easy panning, tilting and zooming using the digital zoom.

Viewer PTZ	Digital PTZ M50 H65x M64x H76x H751 M74x
Enlarges the specified part of the video transmitted from the camera and then displays it in the viewer.	Transmits only the cropped part of the entire area that can be captured by the camera.
The size of the received data is large.	The size of the received data is small.
Camera control is not required.	Camera control is required.
PTZ operation can be performed independently for each Viewer.	Independent operation cannot be performed by each Viewer. If multiple Viewers are connected, the same Digital PTZ display is applied to the other Viewers.
Custom trim size	Five levels of trim size

Magnifying and Display Part of Video (Viewer PTZ)

You can use the Viewer PTZ to magnify part of a video (using digital zoom) without moving the camera. This feature does not use the camera's pan, tilt, or zoom features, making it useful for situations like the use of the intelligent function, where you do not want to change the camera position.

Important **R1x** **M50**

You cannot perform camera operations by clicking/dragging in the video display area while using the Viewer PTZ.

Note

- You cannot record the video magnified with the Viewer PTZ.
- You can display the magnified video in full screen mode when using the Viewer PTZ.

1 Click the [Viewer PTZ] button.

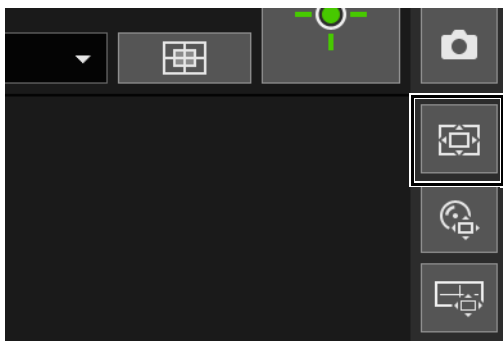

The [Viewer PTZ] button changes active (purple), and the Viewer PTZ panel is displayed in the control display area.

Initially, the preview frame (light blue) surrounds the entire video.

2 In the Viewer PTZ panel, drag an edge of the preview frame to make it smaller.

The video of the area inside the preview frame is magnified to fill the video display area.

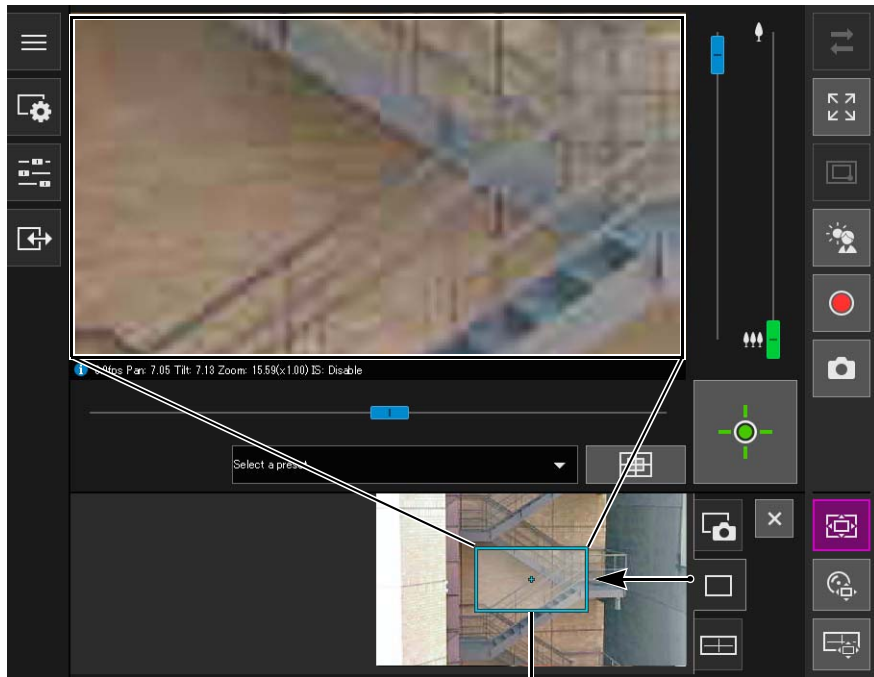

Preview Frame

3 Move the frame to the area you would like to magnify and resize the frame as desired.

Move or Resize by Dragging

Press the mouse button inside the frame and drag it to move the preview frame. If you press the mouse button and drag outside the frame, a new preview frame will be drawn. You can resize the preview frame by dragging an edge of the frame.

Move by Clicking

If you click outside the frame, the preview frame will move and center on that point.

Move Using the Sliders/Resize **H65x M64x H76x H751 M74x**

You can use the pan, tilt and zoom sliders in the video display area to move the preview frame. You can use the zoom slider to resize the image within preview frame.

Note

The Viewer PTZ uses digital zoom, so the higher the digital zoom ratio, the lower the quality of the video.

Exiting Viewer PTZ

The Viewer PTZ exits if you perform one of the following operations.

- Click the Viewer PTZ button to disable it.
- Click the Digital PTZ button to start the Digital PTZ. **M50 H65x M64x H76x H751 M74x**

Note

You can also perform the following operations to retain the zoomed view of the video display area without exiting the Viewer PTZ while the Viewer PTZ button is active (purple).

- Click the [Close] button on the control display area to close the Viewer PTZ panel.
- Click the snapshot tab or panorama display tab **R1x M50** to switch the panel in the control display area.

Cropping and Displaying Part of an Image (Digital PTZ)

M50 H65x M64x H76x H751 M74x

You can use the Digital PTZ panel to crop and display part of a camera image in the image display area.

Note

If you enable Digital PTZ while receiving H.264 video, the received video is switched to JPEG.

Cropping Video With Digital PTZ Panel

- 1 Click the [Digital PTZ] button.



The [Digital PTZ] button changes active (purple), and the Digital PTZ panel is shown in the control display area.

- 2 In the Digital PTZ panel, move and resize the preview frame.

The preview frame operations are the same as with the Viewer PTZ (P. 73).

The preview frame size can be set to any of 5 sizes. The screen sizes according to the setting in [Basic] > [Video] > [All Videos] > [Video Size Set] (P. 102) on the Setting Page.

- When the aspect ratio 16:9 is selected: 640 x 360, 512 x 288, 384 x 216, 256 x 144, 128 x 72
- When the aspect ratio 4:3 is selected: 640 x 480, 512 x 384, 384 x 288, 256 x 192, 128 x 96

Note

The preview frame will move in steps. Fine-tuned movement is not possible.

The video of the area inside the manipulated preview frame is magnified to fill the video display area.

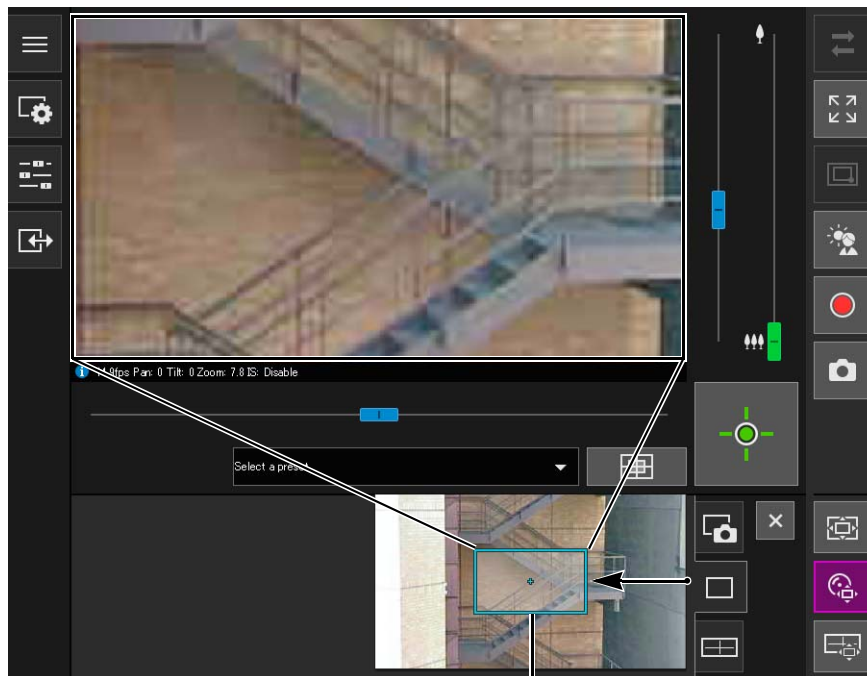

Preview Frame



Important **M50** **H76x**

Even if the camera angle is changed due to a slider operation or preset, the position of the preview frame on the Digital PTZ panel is fixed.



Note

The Digital PTZ uses digital zoom, so the higher the digital zoom ratio, the lower the video quality.

Using Presets or the Home Position **H65x** **M64x** **H76x** **H751** **M74x**

You can use a registered preset or home position to specify the range for Digital PTZ.

If you select a preset, the preview frame on the Digital PTZ panel moves to the preset position, and the video inside the frame is displayed in the video display area.



Note

Register presets in advance in [Camera] > [Preset] > [Register Preset] on the Setting Page (P. 131).

Exiting Digital PTZ

The Digital PTZ exits if you perform one of the following operations.

- Click the [Digital PTZ] button to disable it.
- Click the [Viewer PTZ] button to start the Viewer PTZ.



Note

You can perform the following operations to continue Digital PTZ while the [Digital PTZ] button is active (purple).

- Click the [Close] button on the control display area to close the Digital PTZ panel.
- Click the snapshot tab or panorama display tab **M50** to switch the panel in the control display area.

Saving Snapshots

You can take snapshots while checking the video in the video display area.

- 1 Click the [Snapshot] button at the moment you want to capture a still image.



The snapshot panel is opened in the control display area and the still image from the instant that the button was clicked is displayed.

If you click the [Snapshot] button again, the image displayed in the Snapshot panel will be updated.

- 2 To save the snapshot, right-click on the Snapshot panel.

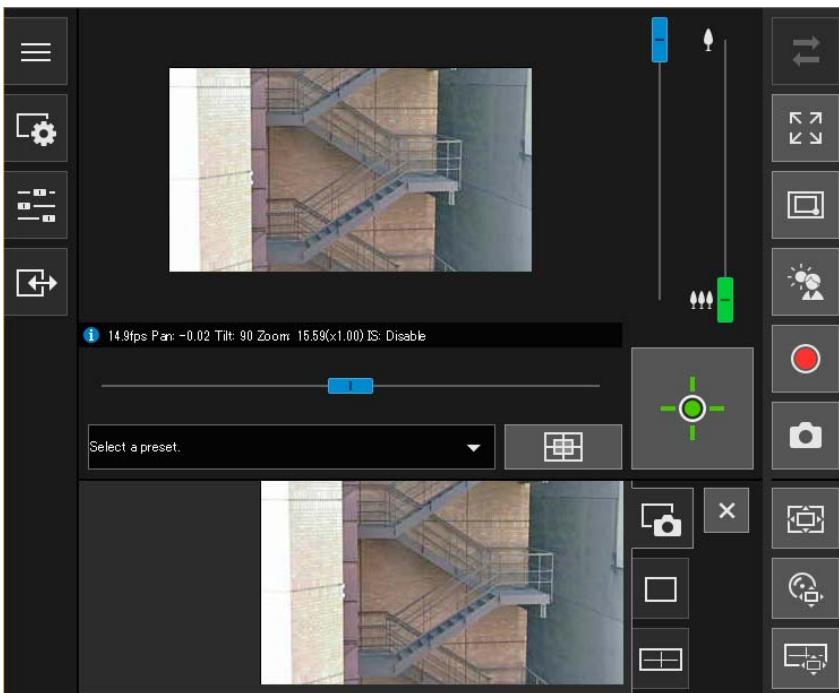

- 3 Click [Save picture as] in the menu that is displayed.

- 4 Enter the desired file name and save the snapshot.

Note

- The snapshot is saved as a JPEG file.
- The saved snapshots are the same size as the reception video size.

Recording Video to a Memory Card

Manually record video being displayed in the video display area to a memory card inserted in the camera.

Note



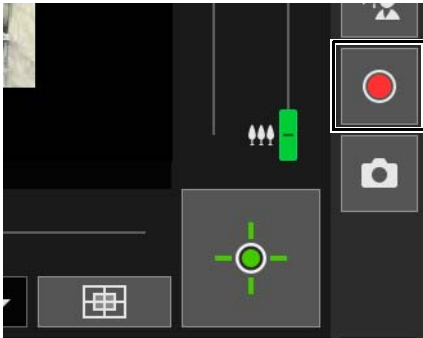

- You can manually record video if the following conditions have been met.
 - The memory card inserted in the camera is mounted.
 - [Operation Settings] is set to [Save Logs and Videos] in [Memory Card] > [Memory Card Operations] (P. 217) on the Setting Page.
- The format and size of the video recorded to a memory card depends on the settings configured on the Setting Page.
 - Video format: [Memory Card] > [Memory Card Operations] > [Video Format] (P. 218)
 - Video size: JPEG [Basic] > [Video] > [JPEG] > [Video Size: Upload / Memory card]
H.264 [Basic] > [Video] > [H.264(1)] or [H.264(2)] > [Video Size]

Recording Videos Manually

- 1 If you have not obtained camera control privileges, click the [Obtain/Release Camera Control Privileges] button to obtain the privileges.
- 2 Click the [Memory Card Recording] button.



The display of the [Memory Card Recording] button will change during video recording.

-  Recording
-  Recording (while camera control privileges are not obtained)
-  Not recording (while camera control privileges are obtained)
-  Not recording (while camera control privileges are not obtained, or when no memory card is mounted to the camera)

- 3 To stop video recording, click the [Memory Card Recording] button again.

Important

- Video manually recorded to the memory card will automatically be terminated after 300 seconds of recording.
- When recording manually, do not change the settings in the [Settings Page]. Doing so may result in the termination of the manual recording.
- While manually recording to the memory card, you can continue to record even if you release camera control privileges or disconnect the camera.

Confirming Recorded Video

Use the Recorded Video Utility to confirm and play back the video manually recorded to a memory card.
For details, please refer to "Recorded Video Utility User Manual".

Open the [Video and Audio] menu to set the audio reception from the camera, the audio transmission from the Viewer and the corresponding volumes.

Receiving Audio

Receive audio from the microphone connected to the camera and play it back in the Viewer.

- 1 In the  [Video and Audio] menu, click the [Audio Reception] button.



Audio reception starts.

The [Audio Reception] button icon will change to active (purple) while receiving audio.

- 2 In [Output Volume], adjust the volume to an appropriate level using the slider.



Note

- To receive audio, you must connect the microphone to the camera and set [Server] > [Audio Server] > [Audio Transmission from the Camera] to [Enable] on the Setting Page (P. 155).
- While the icon is active (purple), audio is constantly received even if you close the [Video and Audio] menu.
- To use the audio function in environments that use a proxy server, select [Use a proxy server for your LAN] in [Network and Internet] > [Internet options] > [Connections] tab > [LAN settings] > [Proxy server] in [Control Panel], then specify the camera IP address in [Advanced] > [Exceptions].

Transmitting Audio

You can transmit audio received from an external device connected to the computer to a speaker with an amplifier connected to the camera.

- 1 In the  [Video and Audio] menu, select the maximum audio transmission time.

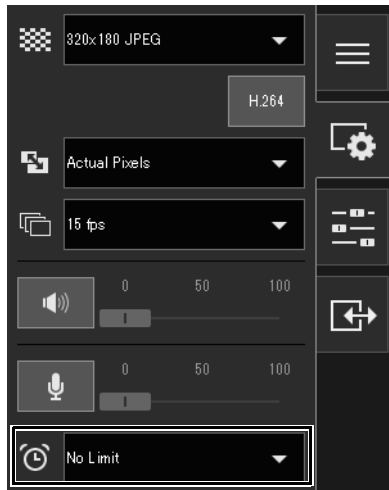

2 Click the [Audio Transmission] button.

Audio transmission starts.

The [Audio Transmission] button icon will change to active (purple) while transmitting audio.



3 In [Input Volume], adjust the volume to an appropriate level using the slider.

Note

- To transmit audio, you must first set [Server] > [Audio Server] > [Audio Reception from Viewer] to [Enable] on the Setting Page (P. 155).
- While the icon is active (purple), audio is constantly transmitted even if you close the [Video and Audio] menu.
- To use the audio function in environments that use a proxy server, select [Use a proxy server for your LAN] in [Internet options] > [Connections] tab > [LAN settings] > [Proxy server] in the Internet Explorer, then specify the camera IP address in [Advanced] > [Exceptions].

Checking the Status of Event Detection

In the  [Event and Input/Output] menu, you can operate the output of an external device and check the status of input of the external device, detection of intelligent functions, and occurrence of linked events.

Operating External Device Output

R13 R11 M50 **H65x** M641 H761 H751 M741

You can operate output for the external device set in [Event] > [External Device] (P. 163) on the Setting Page. Click the icon to switch between the active (purple)/inactive (gray) status.

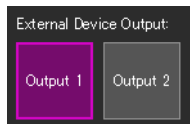



Output 1: Output active
Output 2: Output inactive

Note

To operate [External Device Output] output, it is necessary to obtain camera control privileges.

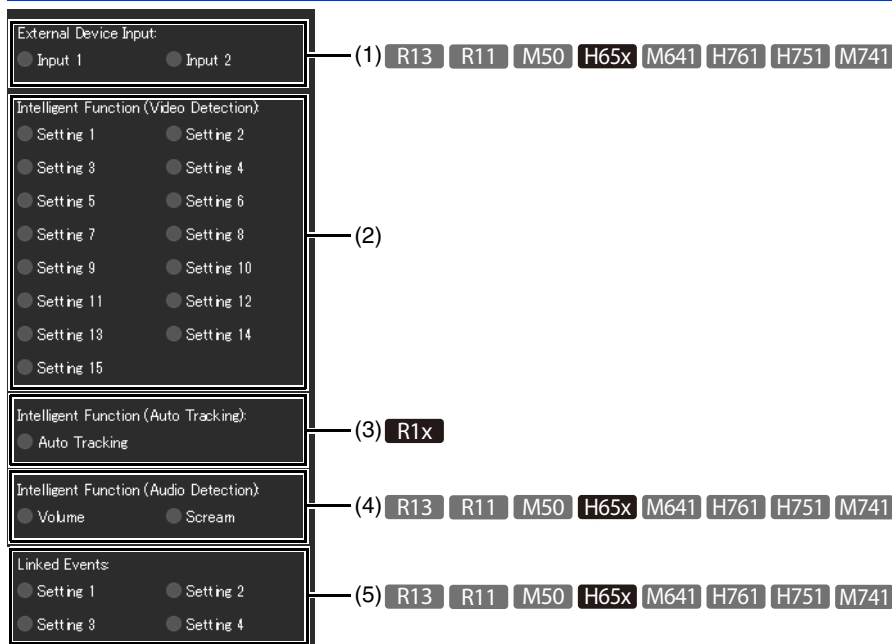
Checking the Status of Event Detection



- (1) **[External Device Input]** R13 R11 M50 **H65x** M641 H761 H751 M741
Displays the input status of the external device set in [Event] > [External Device] (P. 164) on the Setting Page. When a contact input signal is received from an external device, input will be activated and the icon becomes green.
Example:

Input 1: Input inactive
Input 2: Input active
- (2) **[Intelligent Function (Video Detection)]**
The status of video detection set in [Event] > [Intelligent Function] > [Video Detection] (P. 177) is displayed for each detection setting number. When the detection settings configured in Intelligent Function (Moving Object Detection, Abandoned Object Detection, Removed Object Detection, Camera Tampering Detection, Passing Detection, or Intrusion Detection) are triggered, the corresponding icon will turn green.

If a name is entered in [Detection Settings Name] in [Event] > [Intelligent Function] on the Setting Page (P. 182), that name is displayed in [Setting 1] - [Setting 15].

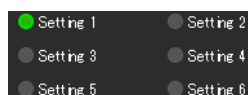
Example:



Setting 1: Video Detection status ON

Other settings: Video Detection status OFF

Note

The icon indicating the detection status will be displayed for a maximum of five minutes (except for Moving Object Detection).

(3) [Intelligent Function (Auto Tracking)] **R1x**

Displays the status of Auto Tracking set in [Event] > [Intelligent Function] > [Auto Tracking] (P. 194) on the Setting Page. If detection is triggered, the icon will turn green.

Example:



Auto Tracking status ON

(4) [Intelligent Function (Audio Detection)] **R13 R11 M50 H65x M641 H761 H751 M741**

Displays the status of [Volume Detection] or [Scream Detection] set in [Event] > [Audio Detection] (P. 166) on the Setting Page. If detection is triggered, the icon will turn green.

Example:



Volume: Volume Detection status ON

Scream: Scream Detection status OFF

(5) [Linked Events] **R13 R11 M50 H65x M641 H761 H751 M741**

Displays the status of linked events set with [Event] > [Linked Event] (P. 202) on the Setting Page. If a linked event is triggered, the icon will turn green.

Example:



Setting 2: Linked Event status ON

Other settings: Linked Event status OFF

Chapter 5

Setting Page

The Setting Page enables you to configure all the settings required for using the camera. Please configure the settings on the Setting page according to how the camera will be used, before you use the camera. The Setting Page also provides menus for when the camera is in operation; for example, camera maintenance.

How to Use The Setting Page

This section explains operations up to displaying the Setting Page, and common Setting Page operations.

Note

- The Setting Page can only be operated by administrators.
- Use the Camera Management Tool in advance to configure the administrator account and network settings (P. 38).

Accessing the Setting Page

Directly enter the IP address set in the Camera Management Tool (P. 40) to display the Setting Page of the camera.

Note

You can also access the Setting Page from the Camera Management Tool. For details, please refer to “Camera Management Tool User Manual”.

- 1** Launch the web browser.
- 2** Enter the IP address, and press the Enter key.
The user authentication window is displayed.
- 3** Enter the Administrator Name and Administrator Password (P. 38) and click [OK].
The Setting Page is displayed.

Note

The Viewer is displayed when [Basic] > [Viewer] > [General] > [Default Page] is set to [Display Viewer] in the setting menu (P. 105).

Settings Menu

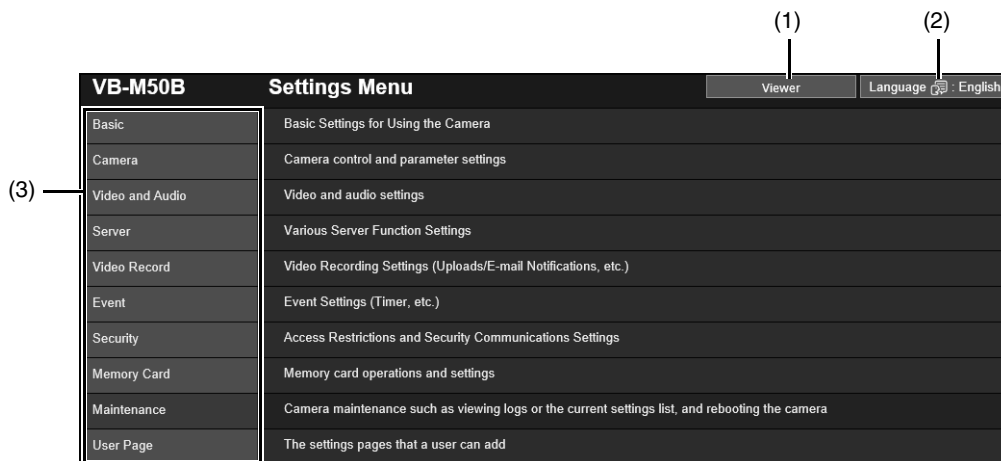

- (1) [Viewer] Button**
Start the Camera Viewer (P. 51).
- (2) Language Switch Button**
Set the language to display on the screen.
- (3) Setting Menus**
If you click one of these items, its submenu (P. 90) will be displayed (excluding the [Memory Card] and [User Page] menus). Click a submenu to navigate to its Setting Page.

 **Important**

- If you open another window or tab to access the camera while an authenticated web page is displayed, the authentication information of the displayed web page may be discarded. In this case, enter the authentication information again.
- To ensure security, exit the web browser after completing settings on the Setting Page and after using the Camera Viewer.
- Do not open multiple Setting Pages at one time and try to change the settings of a single camera.

 **Note** R11 R10 M64x M74x

The following message is displayed to the right of the title of the settings menu even when the administrator password of more than eight characters is set.
 "8 characters or more are recommended for the administrator password."

Common Setting Page Operations

This section explains basic Setting Page operations, and operations common to all Setting Pages.

 **Note**

If you have enabled settings in your web browser to not display dialog boxes, you may be unable to perform operations on the Setting Page. If this happens, exit your web browser and launch it again.

■ Applying Changes to Settings

If you change a setting on the Setting Page, the [Apply] and [Clear] buttons on the upper right or lower right of the screen is no longer grayed out and can be clicked.



Click [Apply] in this state to apply the changed settings.
 Click [Clear] to revert to the previous settings.

■ Setting Changes Requiring Rebooting

Items that require the camera to be rebooted in order to apply the changed settings are indicated with an orange symbol to their right.



When any item indicated with an orange symbol is changed, [Apply] displayed at the upper right and lower right of each Setting Page changes to [Apply and reboot].

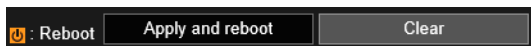

Click [Apply and reboot] to apply the changed settings and reboot the camera.
 Click [Clear] to revert to the previous settings.

 **Important**

Setting changes will be lost if you navigate to another Setting Page without clicking [Apply] or [Apply and reboot]. Be sure to click [Apply] or [Apply and reboot] to apply the changed settings. However, changes for [Camera Angle] and [Initial Settings] are saved even if you navigate to another page without clicking [Apply], so click [Clear] if you want to discard those settings.

■ Return to the Settings Menu

Click [Settings Menu] at the upper right of each Setting Page to return to the setting menu.

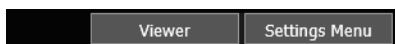

Important

Do not use the [Back] or [Forward] buttons in the web browser to navigate Setting Pages. The changed settings may revert to the original settings or unwanted setting changes may be applied.

■ Help

Click  [Help] at the beginning of any setting item to display a detailed explanation of that setting item.

■ Setting Ranges and Character Limits

For settings where you must enter numerical values or characters, the setting range or limits on the number of characters will be displayed.

Please enter the settings within the displayed limits.



Operating the Video Display Area

Some Setting Pages such as [Initial Settings], [Preset] and [Intelligent Function] can be configured using the video display area.

Note

- The displayed items will change depending on the Setting Page.
- Other users cannot access the Viewer while video is being displayed on the Setting Page. Also, video cannot be displayed or configured while the administrator is connected to the Viewer.

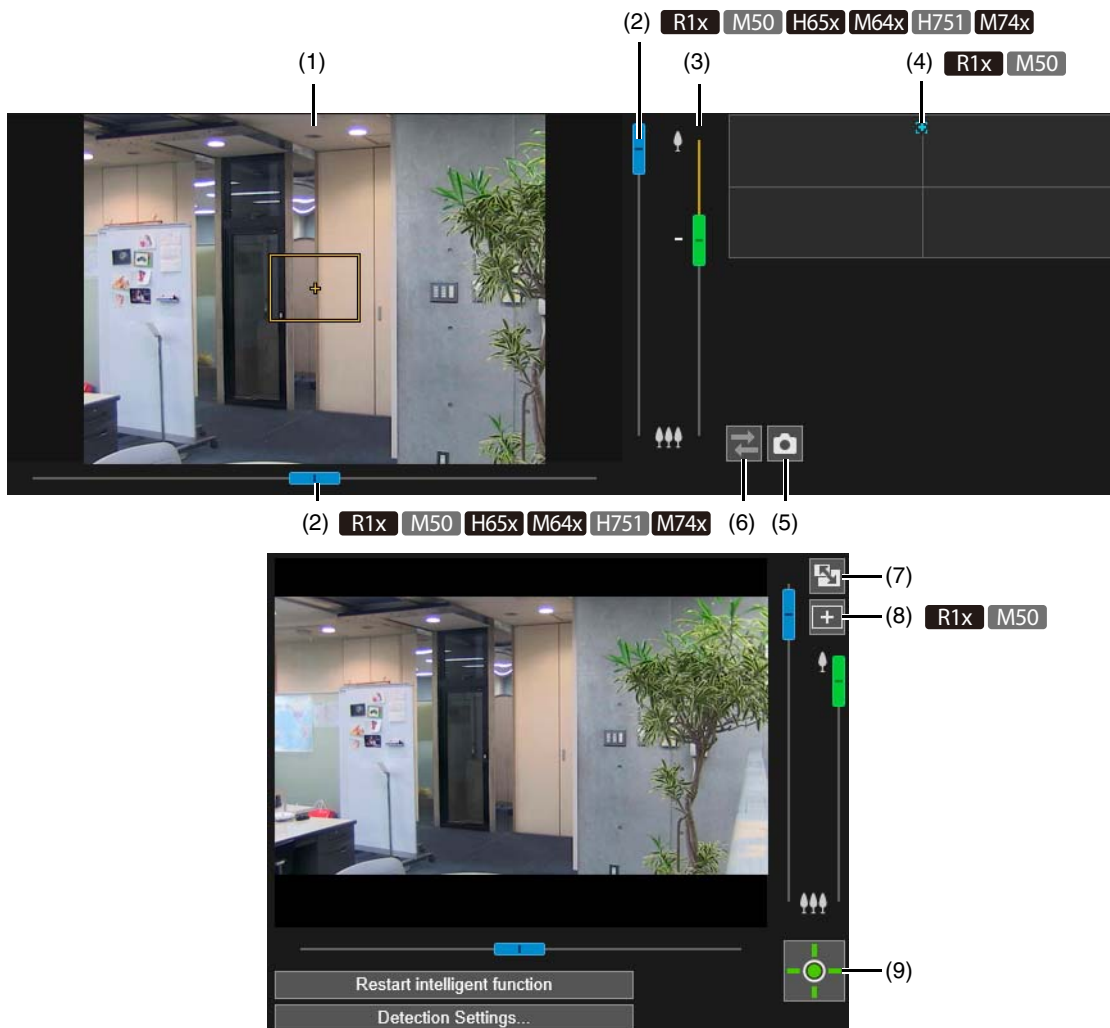

(1) Video Display Area

Camera video is displayed here. Use the mouse to set the areas, etc. The operations on the video display area are the same as in the Viewer (P. 66).

R1x M50

You can perform the following operations while the cursor is [+] in the video display area for some Setting Pages.

- Centering the camera angle to the position you click (P. 66)
- Area zoom operations (P. 67)

(2) Pan/Tilt Slider **R1x M50 H65x M64x H751 M74x**

Pan and tilt operations are the same as in the viewer (P. 66).

(3) Zoom Slider

Zoom operations are the same as in the viewer (P. 66).

(4) Panorama Screen/Full-View Screen

Displays the full range of motion of the camera. You can set areas, etc. using mouse operations on the panorama screen for some Setting Pages.

R1x M50

If a panorama image is registered in the camera (P. 123), the panorama image is displayed.

(5) [Snapshot] Button

Open the snapshot window and display a still image of the moment you clicked the button (P. 77).

(6) [Reconnect] Button

Reconnects to the camera. You can use this when not connecting to the camera.

(7) [Screen Resize] Button

The size of the video display area is switched each time this button is clicked.

(8) [Switch Mouse Operation] Button **R1x M50**

Click this button to perform camera pan/tilt operations on the video display area using the mouse while the button is purple.

(9) [Obtain/Release Camera Control Privileges] Button

Click this to obtain and release the camera control privileges (P. 65).

About Each Setting Page

This section will give an overview of each item in the Settings Menu and each submenu.

Each of the [Basic], [Video and Audio], [Video], and [Video Record] menus has a [Video] submenu, but the functions are all common. The functions can be set in any of the menus and the settings will be reflected in all of the [Video] submenus.

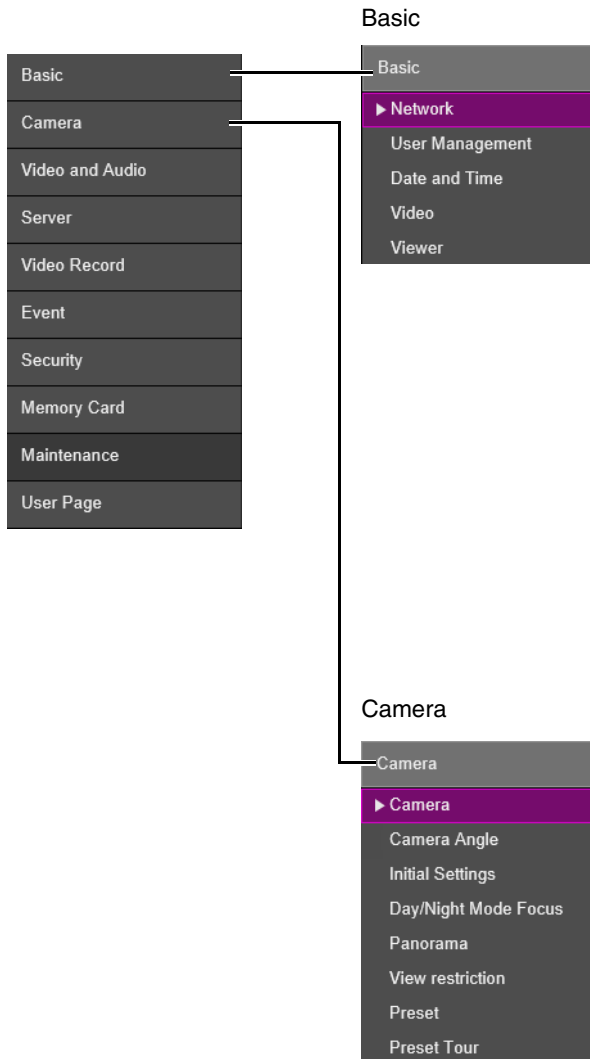

- **Network (P. 94)**
Network settings for connecting to the camera.
 - **User Management (P. 98)**
Use this to change administrator account information, add/delete authorized users and set privileges for users. The settings of this item are the same as those in [Security] > [User Management]. Settings configured on one page are also reflected on the other.
 - **Date and Time (P. 100)**
Camera date and time settings.
 - **Video (P. 102)**
General video settings, such as the size and quality of video transmitted from the camera.
 - **Viewer (P. 105)**
Configure the startup, authorization, and view of the Viewer.
-
- **Camera (P. 107)**
Settings for the camera name and external input/output devices, and for use and installation of the camera.
 - **Camera Angle (P. 43) H651 M64x**
After installing the camera, set the camera angle, while checking the displayed video.
 - **Initial Settings (P. 112)**
Sets initial settings, such as video quality compensation, at camera start up.
 - **Day/Night Mode Focus (P. 120)**
Set the focus positions for when Day/Night Mode are switched.
 - **Panorama (P. 123) R1x M50**
Configure the creation and management of panorama images.
 - **View restriction (P. 127) R1x M50 H76x**
Set the range that the camera can capture.
 - **Preset (P. 131)**
Register a series of settings as a preset.
 - **Preset Tour (P. 135)**
Configure the settings for automatically touring with multiple presets registered in advance.

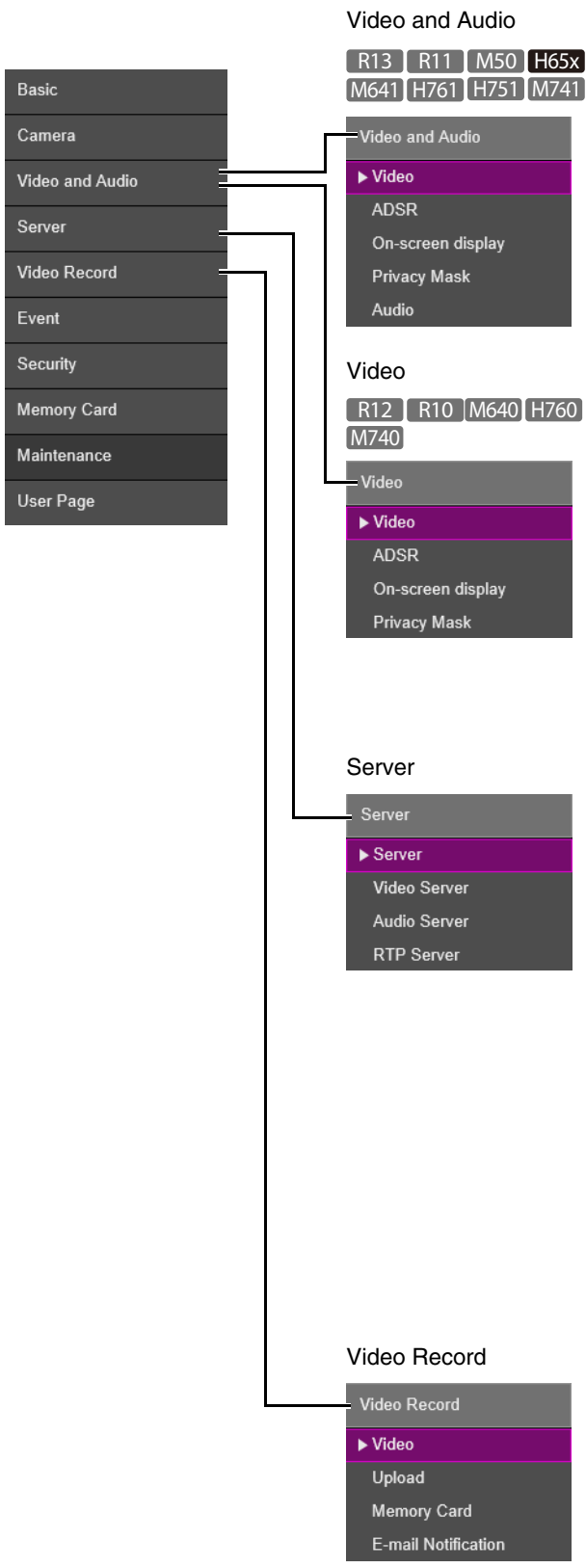

- **Video (P. 102)**
- **ADSR (P. 141)**
ADSR is an abbreviation for Area-specific Data Size Reduction.
Reduces the data size of transmitted H.264 video by reducing the video quality of unspecified area.
- **On-screen display (P. 143)**
Displays the date and time, camera name and other text on the Video.
- **Privacy Mask (P. 145)**
Configure a mask for the areas of the camera video you want to mask.
- **Audio (P. 149)**
Settings for audio input from the microphone connected to the camera, audio output from the Viewer and playback of a sound clip.
- **Server (P. 151)**
Settings for HTTP server, SNMP server, FTP server usage or WS-Security time checks.
- **Video Server (P. 154)**
Settings for clients that can be connected to a video server.
- **Audio Server (P. 155)**
Settings for audio transmission from the camera to the computer, and audio reception from the computer to the camera.
- **RTP Server (P. 156)**
Settings for RTP streaming.
- **Video (P. 102)**
- **Upload (P. 158)**
Settings for uploading video via HTTP or FTP when an event is triggered.
- **Memory Card (P. 217)**
Perform memory card operations or configure settings. The settings of this item are the same as those of the [Memory Card] menu. Settings configured on one page are also reflected on the other.
- **E-mail Notification (P. 162)**
Settings for sending an e-mail notification to a specified recipient when an event is triggered.



- External Device (P. 163)**
R13 R11 M50 H65x M641 H761 H751 M741
 Operation settings for external device output and for external device input triggered events.
- Audio Detection (P. 166)**
R13 R11 M50 H65x M641 H761 H751 M741
 Detected changes in audio input from the microphone connected to the camera can trigger operations such as video recording or e-mail notification.
- Timer (P. 169)**
 The timer function can generate events that can trigger operations, such as video recording and e-mail notifications, at regular intervals.
- Intelligent Function (P. 171)**
 Configure the intelligent functions such as moving object detection, camera tampering detection, and intrusion detection.
- Switch Day/Night (P. 201)**
 The camera angle can be moved to preset positions when Day Mode and Night Mode are switched.
- Linked Event (P. 202)**
R13 R11 M50 H65x M641 H761 H751 M741
 By linking two types of events, a single event is triggered.
- User Management (P. 98)**
 The settings of this item are the same as those of the [User Management] in [Basic] menu. Settings configured on one page are also reflected on the other.
- Host Access Restrictions (P. 206)**
 Separate access control from IPv4 and IPv6 addresses can be set.
- SSL/TLS (P. 208)**
 Certificate creation and management, and encrypted communication settings.
- 802.1X (P. 211)**
 Settings for 802.1X authentication and authentication status display, and for certificate management.
- IPsec (P. 213)**
 Settings for using IPsec.
- Memory Card (P. 217)**
 Settings for recording video to a memory card when an event is triggered.
 The settings of this item are the same as those in [Video Record] > [Memory Card]. Settings configured on one page are also reflected on the other.
- General (P. 220)**
 Check the device information/settings, and licenses, and reboot and initialize the device, etc.
- Backup / Restore (P. 222)**
 Perform backup and restoration.
- Update Firmware (P. 223)**
 Perform firmware updates.
- Log (P. 224)**
 Display logs and configure log notification.

User Page
 Link to web page customized by the user.
 For information on the User Page, contact a Canon Customer Service Center.

When analog video output is enabled for the camera, a message is displayed in the following submenus of the Settings Page.

- Video, Initial Settings, Day/Night Mode Focus, Preset, Preset Tour, ADSR, Privacy Mask, RTP Server, Upload, Memory Card, Intelligent Function

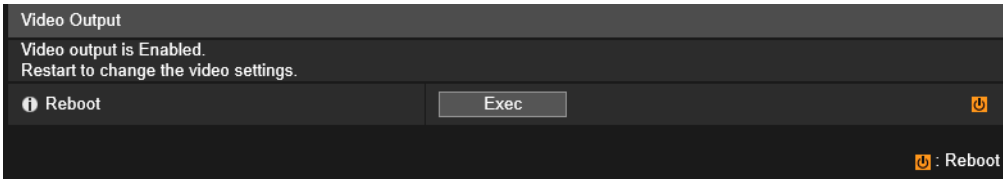

Video output automatically reboots the camera after 30 minutes have elapsed. After rebooting, video output is disabled and the submenus can be configured.

[Reboot]

To change video settings, click [Exec] to reboot the camera.

Note

For details on analog video output, please refer to the "Installation Guide".

[Basic] > [Network] Configuring Network Settings

Network settings for connecting to the camera.

The following settings can be configured here.

- LAN
- IPv4
- IPv6
- DNS
- mDNS

Important

If any network settings are changed, the camera may become inaccessible from the active web browser. In this case, a confirmation dialog box will be displayed when you click [Apply] or [Apply and reboot]. Click [OK] to apply the new settings.

If you reboot the camera after changing settings and cannot connect to the camera from the web browser, any available URI for connecting to the camera will be displayed in a message. If you cannot connect to the camera through the displayed URI, contact your system administrator.

LAN

Set the LAN communication method and size of video transmitted from the camera.

[LAN Interface]

Select the interface suited to the device for connecting to the camera. Generally use [Auto].

[Maximum Packet Size]

Enter the maximum packet size to be transmitted by the camera. Normally there is no need to change the default setting of 1500.

A setting of 1280 or greater is necessary when using IPv6.

When using ADSL, setting a slightly lower value may increase transmission efficiency.

IPv4

Settings for using IPv4 to connect to the camera. The IPv4 address can be assigned by the DHCP server automatically or set manually.

 **Important**

- Contact your System Administrator for the [IPv4 Address], [Subnet Mask] and [IPv4 Default Gateway Address] if you set the IPv4 address manually.
- If any of the [IPv4 Address], [Subnet Mask] or [IPv4 Default Gateway Address] settings are wrong, the camera may become inaccessible via the network. If this occurs, use the Camera Management Tool to reset the address (P. 40).

[IPv4 Address Settings Method]

Select the method for setting the IPv4 address.

For [Manual], enter a fixed IPv4 address into [IPv4 Address].

For [Auto (DHCP)], the settings acquired from the DHCP server will be automatically entered in [IPv4 Address], [Subnet Mask] and [IPv4 Default Gateway Address].

 **Important**

If [Auto (DHCP)] is selected as the IPv4 address setting method, the IPv4 address may not be assigned correctly in certain environments, such as when a router is present between the DHCP server and the camera. If this occurs, select [Manual] and enter a fixed IPv4 address.

[IPv4 Address]

When [IPv4 Address Settings Method] is set to [Manual], enter a fixed IPv4 address.

The IP address cannot start with 127., such as 127.0.0.1.

[Subnet Mask]

When [IPv4 Address Settings Method] is set to [Manual], enter the designated subnet mask values for each network.

[IPv4 Default Gateway Address]

When [IPv4 Address Settings Method] is set to [Manual], enter a default gateway IP address. Be sure to set this when connecting the camera to a different subnet from that of the Viewer.

[AutoIP]

Select this to enable or disable AutoIP.

[IPv4 Address (AutoIP)]

When [AutoIP] is set to [Enable], an automatically set IPv4 address is displayed.

IPv6

Settings for using IPv6 to connect to the camera. The IPv6 address can be assigned by the RA or DHCPv6 server automatically or set manually.

 **Important**

Contact your System Administrator for the [IPv6 Address (Manual)], [Prefix Length] and [IPv6 Default Gateway Address] if you set the IPv6 address manually.

[IPv6]

Select this to enable or disable IPv6.

[Auto (RA)]

Select [Enable] to set an address automatically using RA (Router Advertisement, network information automatically transmitted from a router).

[Auto (DHCPv6)]

Select [Enable] to use DHCPv6 to set an address automatically.

[IPv6 Address (Manual)]

Enter a fixed IPv6 address if you set the address manually.

[Prefix Length]

Enter a prefix length if [Disable] is specified in [Auto (RA)].

[IPv6 Default Gateway Address]

Enter a default gateway address if [Disable] is specified in [Auto (RA)]. Be sure to set this when connecting the camera to a different subnet from that of the Viewer.

[IPv6 Address (Auto)]

If [Enable] is specified in [IPv6] and [Enable] is specified in [Auto (RA)] and [Auto (DHCPv6)], then the automatically acquired address will be displayed.



Note

In an environment where IPv6 cannot be used, and IPv6/Auto is set to [Enable], then only the link-local address will be displayed in the [IPv6 Address (Auto)] field.

DNS

Set the DNS server address. The DNS server address can be set manually or automatically assigned by a DHCP/DHCPv6 server.

[Name Server Address 1], [Name Server Address 2]

Enter the name server address you want to register. To register only one address, keep the [Name Server Address 2] field blank.



Note

If [Name Server Address 1] is unavailable, [Name Server Address 2] will be accessed. However, [Name Server Address 2] must be set in advance.

[Set Name Server Address Automatically]

Select the server to use for automatically setting the name server address.

To set [Use DHCP], select [Auto (DHCP)] in [IPv4 Address Settings Method] (P. 95).

To set [Use DHCPv6], select [Enable] in [IPv6], then select [Enable] in [Auto (DHCPv6)] (P. 95).

[Name Server Address (DHCP)]

Select [Use DHCP] or [Use DHCP/DHCPv6] in [Set Name Server Address Automatically] to display the name server address acquired from the DHCP server.

[Name Server Address (DHCPv6)]

Select [Use DHCPv6] or [Use DHCP/DHCPv6] in [Set Name Server Address Automatically] to display the name server address acquired from the DHCPv6 server.

[Host Name]

You can register the camera host name in the name server using alphanumeric characters.

Do not use “_” (underscore) in the host name in Internet Explorer 9/10/11.

[Host Name Registration with DDNS]

When you enter a name into [Host Name] and select [Register], the host name will be registered in the name server.

Registering the host name to DDNS is useful when operating with [IPv4 Address Settings Method] set to [Auto (DHCP)] (P. 95). DNS server registration settings must be set in advance. Contact your system administrator for the DNS server settings.

[Search Domain]

Enter a domain name and click [Add] to add the domain name to the Search Domain List.

Specify the host name without specifying a domain name for a server, such as the upload server, to search domains in the form “host name + domain name”, when the domain names are specified in the Search Domain List.

Do not use “_” (underscore) in the domain name in Internet Explorer 9/10/11.

[Search Domain List]

A list of domain names added using [Search Domain].

The function queries the DNS server for each domain name starting from the top of the list.

Use the ▲▼ buttons on the right to change the order of the domain names.

To delete a domain name, select one from the list and then click [Delete].

mDNS

This will configure settings for using multicast DNS. If you use mDNS, the IP address and host name of the camera will be broadcast to other hosts on the network.

[Use mDNS]

Select this to enable or disable mDNS.

[Basic] > [User Management] Configuring Accounts and Privileges

You can change the administrator account, add new authorized users, and set the privileges for authorized users and guest users.

For details on user privileges, please refer to “Camera Viewer Access Restrictions” (P. 53).

[User Management] is the same as [Security] > [User Management]. Settings configured on one [User Management] page are also reflected on the other.

	Privileged Camera Control	Camera Control	Video Distribution	Audio Distribution
Authorized User	<input checked="" type="checkbox"/>	<input checked="" type="checkbox"/>	<input checked="" type="checkbox"/>	<input checked="" type="checkbox"/>
Guest User	<input checked="" type="checkbox"/>	<input checked="" type="checkbox"/>	<input checked="" type="checkbox"/>	<input checked="" type="checkbox"/>

The following settings can be configured here.

- Administrator Account
- Authorized User Account
- User Authority

Administrator Account

Set this when changing the account information for the administrator.

Important

- To ensure system security, change the administrator password periodically. Do not forget the new password.
- If you forget the administrator password, restore the factory default settings (P. 247). Note, however, that this will reset all camera settings to factory default settings including the administrator account, the network information, date and time.

[Administrator Name]

Enter the administrator name using alphanumeric characters, hyphens (-), and underscores (_).

[Password]

Enter the administrator password in alphanumeric characters.

If the Camera Viewer, etc., are connected, terminate the connection before changing the password.

[Confirm Password]

Enter the same password as above for confirmation.

Authorized User Account

Add authorized users.

[User Name], [Password]

To add the authorized user, enter the user name and password, then click [Add].

Enter the user name using alphanumeric characters, hyphens (-), and underscores (_).

Enter the password in alphanumeric characters.

Up to 50 authorized users can be added.

[User List]

Displays a list of added authorized users.

The order of the list can be changed with the ▲▼ buttons on the right.
To delete an authorized user from the list, select the user and click [Delete].

User Authority

Set the privileges for authorized users and guest users. This setting enables you to set access restrictions for the Camera Viewer (P. 53).

[Privileged Camera Control], [Camera Control], [Video Distribution]

[Audio Distribution] R13 R11 M50 H65x M641 H761 H751 M741

Select the items for granting users privileges.

An authorized user has higher privileges than a guest user.

[Basic] > [Date and Time] Setting the Date/Time

Camera date and time settings.

Date and Time		Apply	Clear
Current Date and Time			
Date	yyyy/mm/dd	2016/10/21	
Time	hh:mm:ss	21:48:18	
Settings			
Settings Method		Set manually	
Date	yyyy/mm/dd	2016/10/21	
Time	hh:mm:ss	21:48:18	
Time Zone		(GMT+09:00) Osaka, Sapporo, Tokyo	
Daylight Saving Time		Disable	

The following settings can be configured here.

- Current Date and Time
- Settings

Current Date and Time

The date and time set in the camera are displayed.

Settings

Set the date and time setting method, time zone and daylight saving time for the camera.

[Settings Method]

Select the date and time setting method.

[Set manually]

Set the desired date and time in [Date] and [Time].

Set the time in 24-hour format in <hour:minute:second> order.

[Synchronize with NTP server]

Select the setting method displayed in [Set NTP Server Settings Automatically].

[Disable]

Enter the IP address or host name of the NTP server in [NTP Server].

[Use DHCP]

The camera time is synchronized with the time of the NTP server at the address acquired from the DHCP server. The acquired NTP server address is displayed in [NTP Server (DHCP)].

In order to set [Use DHCP], you must change [Network] > [IPv4] > [IPv4 Address Settings Method] to [Auto (DHCP)] (P. 95).

[Use DHCPv6]

The camera time is synchronized with the time of the NTP server at the address acquired from the DHCPv6 server. The acquired NTP server address is displayed in [NTP Server (DHCPv6)].

In order to set [Use DHCPv6], you must change [Network] > [IPv6] > [IPv6] to [Enable], then set [Auto (DHCPv6)] to [Enable] (P. 95).

[Use DHCP/DHCPv6]

The camera time is synchronized with the time of the NTP server at the address acquired from the DHCP server or DHCPv6 server.

If the NTP server address can be acquired from both the DHCP server (IPv4) and DHCPv6 server, the NTP server address acquired from the DHCP server (IPv4) will be used.

[Synchronization Interval (minutes)]

Enter the synchronization interval for the specified NTP server.

[Last Sync Time]

The time last synchronized with the specified NTP server will be displayed.

[Synchronize with computer time]

The date and time will be synchronized with that of the computer currently accessing the camera. After clicking [Apply], [Settings Method] will change to [Set manually].
[Time Zone] is not automatically selected, so set it if necessary.

Note

- If the NTP server IP address is incorrect or a connection with the NTP server cannot otherwise be established, [Last Sync Time] will not be updated, or will be blank.
- Synchronization will take time if there is a large difference between the time of the camera and the time of the NTP server.

[Time Zone]

Select the appropriate time zone.

When the time zone is changed and [Apply] is selected, the date and time will be automatically changed based on the selected time zone.

[Daylight Saving Time]

Select whether to automatically adjust for daylight saving time to suit the time zone.

[Basic] > [Video] Setting Video Size and Quality

General video settings, such as the size and quality of JPEG and H.264 video transmitted from the camera. [Video] is common with [Video] found in [Video and Audio] and [Video Record]. A setting configured in any of the [Video] submenus will be reflected in the other [Video] submenus as well.

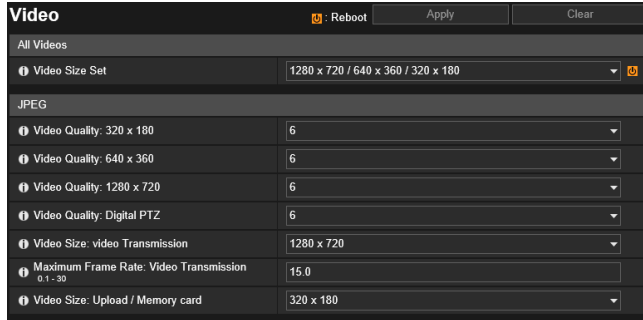

The following settings can be configured here.

- All Videos
- JPEG
- H.264(1)
- H.264(2)

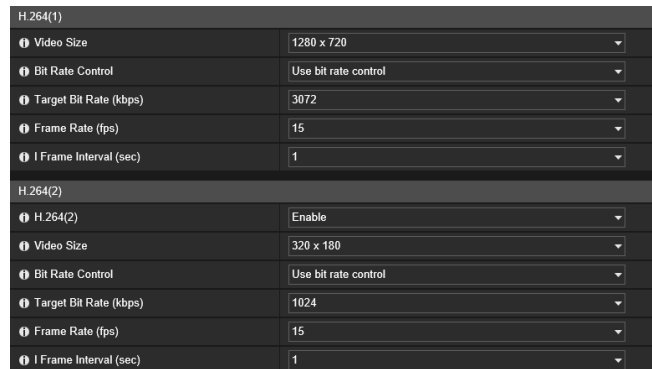

Important

- The following may occur if video size, video quality and target bit rate are set higher, as this increases network load and data size per frame.
 - JPEG: The frame rate may drop
 - H.264: Video may be temporarily disrupted
- In case of H.264 video, block noise may become noticeable if a large video size and low target bit rate are set.
- The data size may increase depending on the type or movement of the subject. If the frame rate remains low or other undesirable conditions continue for a prolonged period, lower the video size or quality setting.
- The included RM-Lite can only record JPEG video.

All Videos

Set the video size sets used by the camera.

All options in the [Video] submenu and the size sets that can be selected in [Video Size] in all of the Setting Pages are determined by the video size set selected here.

This also determines the video sizes and screen sizes that can be selected by each Viewer.

[Video Size Set]

Categories and aspect ratios vary according to each video size set.

R11 **R10** **M50** **M64x** **M74x**

[Video Size Set]	Category	Aspect Ratio
[1280 x 720 / 640 x 360 / 320 x 180]	720p	16:9
[1280 x 960 / 640 x 480 / 320 x 240]	4:3	4:3

[Video Size Set]	Category	Aspect Ratio
[1920 x 1080 / 960 x 540 / 480 x 270]	1080p	16:9
[1280 x 720 / 640 x 360 / 320 x 180]	720p	16:9
[1280 x 960 / 640 x 480 / 320 x 240]	4:3	4:3

Important

Changing the [Video Size Set] selection and clicking [Apply and reboot] will disconnect all connections and then change all the video sizes. Consequently, users connected to the camera must reconnect.

If the [Video Size Set] selection is changed, review the following settings and check the operation.

- ADSR (P. 142)
- Privacy Mask (P. 145)
- Intelligent Function (P. 171)
- Preset (P. 131)
- View Restriction (P. 128) **R1x** **M50** **H76x**
- Camera Angle (P. 45) **H651** **M64x**

JPEG

You can configure settings for the quality and size of JPEG video transmitted from the camera, as well as, the video size when recording the camera video.

The video sizes that can be set or selected depend on the [Video Size Set] setting.

[Video Quality]

Select the video quality transmitted from the camera for each size in a video size set.

Greater values have higher quality.

[Video Quality: Digital PTZ] **M50** **H65x** **M64x** **H76x** **H751** **M74x**

Select the video quality for digital PTZ.

[Video Size: video Transmission]

Select the default video size transmitted from the camera when no video size has been specified by the Viewer.

[Maximum Frame Rate: Video Transmission]

Limit the maximum frame rate per second transmitted to reduce the viewer load. Up to 30 frames per second can be set.

[Video Size: Upload / Memory card]

Select the size of video when using the upload function (P. 158) or when recording to a memory card (P. 217).

Set whether to upload a video or record it to a memory card with [Video Record] > [Upload] or [Memory Card] > [Video Record Action] (P. 158).

H.264(1)

Settings for H.264(1) video transmitted from the camera.

The video sizes that can be selected depend on the [Video Size Set] setting.

[Video Size]

Select the size of the video transmitted from the camera.

[Bit Rate Control]

Set the video bit rate.

If you select [Use bit rate control], please set [Target Bit Rate (kbps)]. If you select [Do not use bit rate control], please set [Video Quality].

[Target Bit Rate (kbps)]

You can select the target bit rate if [Bit Rate Control] is set to [Use bit rate control].

[Video Quality]

You can select the video quality if [Bit Rate Control] is set to [Do not use bit rate control].

Greater values have higher quality.

[Frame Rate (fps)]

Select the video frame rate.

[I Frame Interval (sec)]

Select the I frame interval (sec) for H.264 video.



Important

- When [H.264(1)] or [H.264(2)] video is used for memory card recording and upload, the following restrictions apply to the setting.
 - [Bit Rate Control]: [Use bit rate control] only
 - [Target Bit Rate (kbps)]: [3072] or less
 - [I Frame Interval (sec)]: either [0.5], [1], or [1.5]
- When dual streaming H.264 videos, setting the video size for H.264(1) and H.264(2) to the following combinations restricts the frame rate to a maximum of 15 fps. For all other combinations, a frame rate of up to 30 fps can be selected.

H.264(1)	H.264(2)
1920 x 1080	All sizes
All sizes	1920 x 1080
1280 x 960	1280 x 960
1280 x 720	1280 x 720

H.264(2)

Settings for H.264(2) video transmitted from the camera.

The video sizes that can be selected depend on the [Video Size Set] setting.

[H.264(2)]

Select [Enable] to dual stream H.264 video.

[Video Size], [Bit Rate Control], [Target Bit Rate (kbps)], [Video Quality], [Frame Rate (fps)], [I Frame Interval (sec)]

Please refer to each setting in "H.264(1)".

[Basic] > [Viewer] Configuring the Viewer

Configure the startup, authorization, and view of the Viewer.

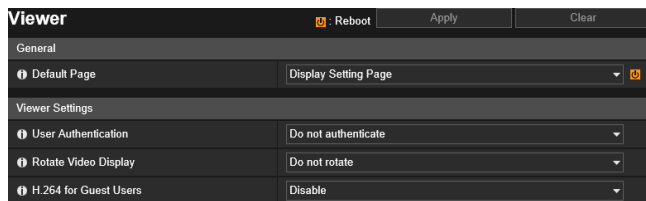

The following settings can be configured here.

- General
- Viewer Settings

General

[Default Page]

Sets the Setting Page or the Viewer as the first page to display when the camera is connected. If users other than the administrator use the Viewer, set [Default Page] to [Display Viewer].

Viewer Settings

[User Authentication]

Displays the user authentication screen when the camera is connected to the Viewer (P. 51). If you select [Authenticate], only the administrator or an authorized user (P. 98) can connect.

[Rotate Video Display] H65x M64x H76x H751 M74x

If you select [Rotate clockwise 90 degrees] or [Rotate counterclockwise 90 degrees], video is displayed in portrait orientation in the Camera Viewer. Use this to rotate the camera 90° to capture video in portrait orientation.

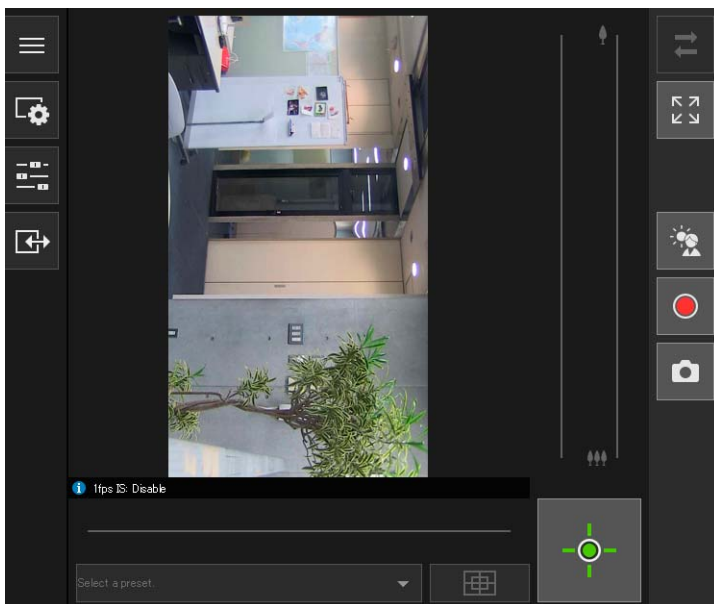

Camera Viewer video when [Rotate clockwise 90 degrees] is set

Note

- Rotation of the video display only affects the Viewer. The video in the video display area of the Setting Page is not rotated. Uploads and video stored on the memory card are not rotated.
- If you rotate the video display, the on-screen display is also rotated.

[H.264 for Guest Users]

Set whether guest users may receive H.264 video. If you select [Enable], the [H.264] button will be displayed even when a guest user connects to the viewer (P. 57).

If you select [Enable], the [CANON SOFTWARE LICENSE AGREEMENT] dialog box is displayed. Click [Yes] to accept the terms of the license agreement.



Important

Additional H.264 licenses are required to receive H.264 video on multiple computers (P. 23). Select [Disable] for environments in which license management cannot be performed, such as environments in which multiple unspecified users access the camera.

[Camera] > [Camera] Setting General Camera Controls

Settings for the camera name and external input/output devices, and for camera use and installation settings.

Camera	
Camera Name	
Camera Name (alphanumeric characters) Up to 15 characters	Camera
Camera Control	
Digital Zoom	Disable
Enhanced Digital Zoom	Disable
Maximum Digital Zoom Magnification	5
Image Stabilizer	Disable
Smart Shade Control Strength (Auto)	Medium
Haze Compensation Strength (Auto)	Medium
Motion-Adaptive Noise Reduction	Disable
Pan/Tilt Speed Control	Control by zoom position
Day/Night (when Auto is set)	
Switching Brightness	Standard
Response (sec.)	20
Clear IR Mode	
Infrared Light Turn On Time	Specify Time
Lighting Time <small>hh:mm</small>	18:00
Light Turn Off Time <small>hh:mm</small>	06:00

The following settings can be configured here.

- Camera Name
- Camera Control
- Day/Night (when Auto is set)
- Clear IR Mode
- Installation Conditions
- Camera Position Control
- External Input Device 1, 2
- External Output Device 1, 2

Installation Conditions	
LED Setting	Turn On
Video Flip	Enable
Camera Position Control	
Restricted to Presets	No Restriction
Camera Position without Control	Do not return to Home Position
External Input Device 1	
Device Name (alphanumeric characters) Up to 15 characters	
External Input Device 2	
Device Name (alphanumeric characters) Up to 15 characters	
External Output Device 1	
Device Name (alphanumeric characters) Up to 15 characters	
External Output Device 2	
Device Name (alphanumeric characters) Up to 15 characters	

Camera Name

Set the camera name.

[Camera Name]

Enter any camera name. Be sure to enter a name in [Camera Name].

Camera Control

Set various controls for easier viewing of video.

[Digital Zoom]

Select this to enable or disable digital zoom.

If [Enable] is selected, the area indicating digital zoom will be displayed next to the zoom slider (P. 67).

Unlike optical zoom, the higher the digital zoom ratio, the lower the video quality.

[Enhanced Digital Zoom] **R1x** **M50** **H76x**

Select this to enable or disable the enhanced digital zoom.

When the video size is small, digital zoom can be used to enlarge it up to the maximum size resolution with reduced video deterioration.

When [Enable] is selected, an area indicating the enhanced digital zoom and a horizontal line (blue) indicating the enhanced digital zoom telephoto end are displayed on the zoom slider of the Viewer (P. 67).

[Maximum Digital Zoom Magnification] **R1x** **M50** **H76x**

Sets the maximum zoom magnification for digital zoom.

[Image Stabilizer]

Select this to enable or disable blur reduction in video due to camera vibration.

If there is still blur after selecting [On1], select [On2].

The angle of view will be narrower and video noisier when using the Image Stabilizer, compared to when it is not used.

Important

- The image stabilizer is not effective when the subject is shaking.
- Stabilization is not effective beyond a certain degree of vibration or for momentary vibrations.
- If you select [On2], it is recommended to select a video reception size less than [640 x 480].
- If you use stabilization, please refer to the information listed in the following "Important" sections.
 - The "Important" section in "Setting Privacy Mask" (P. 147)
 - The "Important" section in "Setting View Restriction" (P. 128). **R1x** **M50** **H76x**
 - The "Important" section in "Viewing Video with the Camera Viewer" (P. 60).
 - The "Important" section in "Registering Presets" (P. 131).

[Smart Shade Control Strength (Auto)]

Select the control strength when [Smart Shade Control] (P. 116) is set to [Auto].

- [Mild]: Select if noise is noticeable.
- [Medium]: Recommended setting for Auto mode (default setting)
- [Strong]: Select to increase visibility in dark areas.

[Haze Compensation Strength (Auto)]

Select the strength of compensation when [Haze Compensation] (P. 118) is set to [Auto].

Note

When [Haze Compensation] is set to [Auto] and [Haze Compensation Strength (Auto)] is set to [Strong], contrast may be strong if the subject is not obscured by haze. If this happens, set [Haze Compensation Strength (Auto)] to [Mild].

[Infrared Light Strength (Auto)] **H652** **H761** **H751** **M741**

Select the infrared illumination strength when you have set [Use Infrared Light] to [Day/Night Operation] in [Initial Settings] (P. 119) and have selected [Auto], [Auto (Flickerless)], [Auto (Shutter-priority AE)] or [Auto (Aperture-priority AE)] for [Exposure] (P. 115).

Note **H652** **H761** **H751** **M741**

- If all or part of the image appears to have a white glow, there is a possibility that a wall (even a wall not in the image) is reflecting the infrared lighting. If this occurs, please adjust the camera angle.
- When using the infrared lighting, and there is a problem in getting the desired contrast on the object (would like the image brighter or darker), please adjust the Exposure Compensation (P. 116) and/or the Metering Mode (P. 116).

[Motion-Adaptive Noise Reduction]

When [Enable] is selected, noise reduction is automatically adjusted according to movement. For scenes in which there is little movement, noise reduction is increased and data size decreases.

Important

The intended effect may not be achievable, depending on the size and movement speed of the subject.

[Pan/Tilt Speed Control] **R1x** **M50**

Select the pan/tilt control mode.

If [Control by zoom position] is selected, the pan/tilt speed will be slower in telephoto, and faster in wide-angle.

[Auto Flip] **R1x**

Select this to enable or disable Auto Flip.

If you enable Auto Flip and tilt the camera using the video display area in the Viewer (P. 66), the video will flip when the tilt angle of the camera nears 100°. Because this operation is effectively the same as panning 180°, at the same time that the video flips, the position of the pan/tilt slider knob moves to the pan/tilt position after flipping.

Note R1x

If you set Auto Flip to [Enable], some of the settings in [View restriction] are disabled (P. 128).

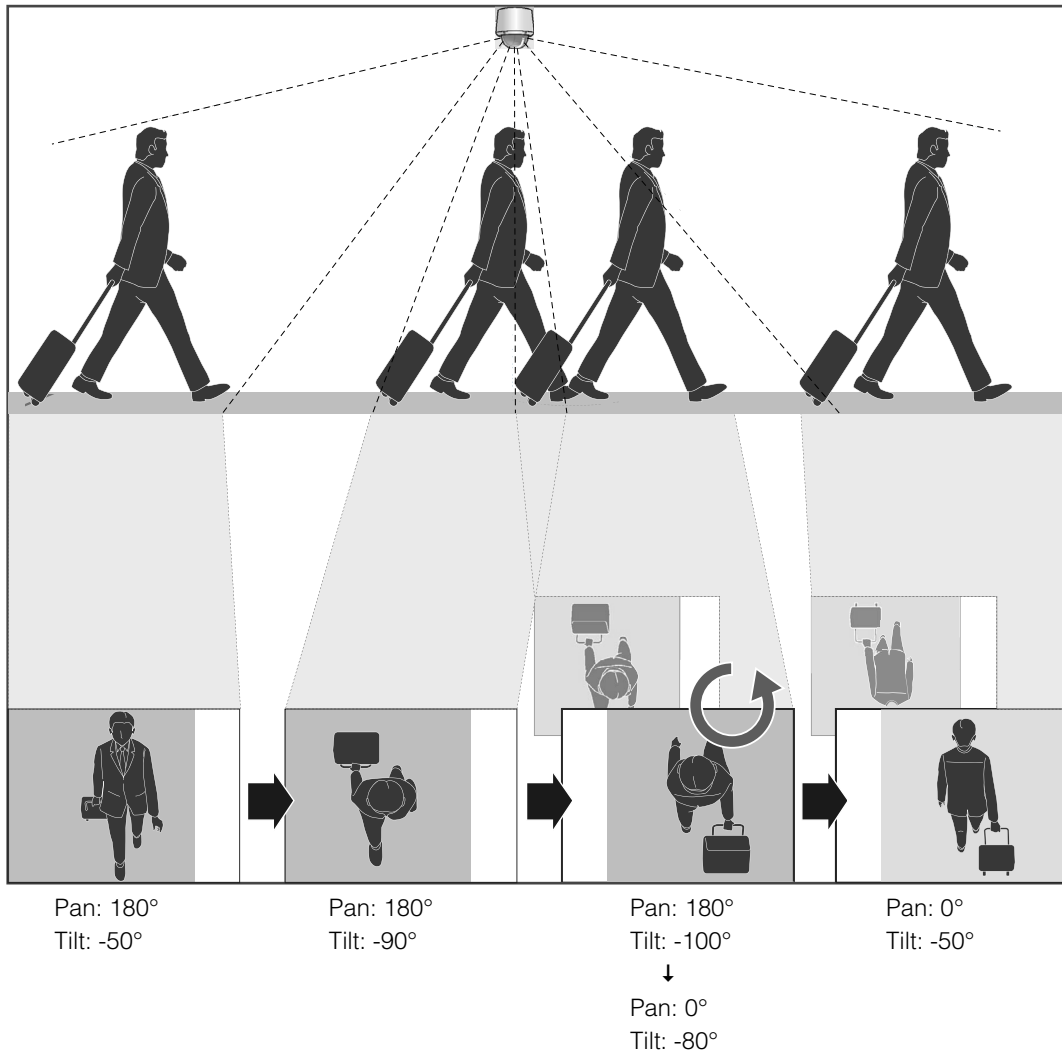

If the tilt angle exceeds 100°, Auto Flip will occur, and the video and coordinates will be flipped.

If tracking a subject that passes directly under a ceiling mounted camera (tilt angle 90°), the video will flip as the tilt angle nears 100° without the subject appearing inverted.

Day/Night (When Auto Is Set)

Set conditions for switching Day Mode and Night Mode when [Day/Night] is set to [Auto].

[Switching Brightness]

Select the brightness for switching Day/Night Mode when [Day/Night] is set to [Auto].

Select [Darker] if you want to capture video in color as much as possible.

Select [Brighter] to reduce noise. Note that this mode switches to monochrome sooner.

[Response (sec.)]

Select the number of seconds for determining when to switch Day/Night Mode, when [Day/Night] is set to [Auto]. Day/Night Mode switches when the brightness continues to exceed or fall below the brightness set in [Switching Brightness] for the number of seconds selected.

Select [30] or [60] if brightness changes frequently, such as when a light source passes in front of the camera. Select [5] or [10] if change in brightness is minimal.

Clear IR Mode

H761

If [Clear IR Mode] is set to [Enable] (P. 118), set the time to turn on the infrared illumination. This can reduce halation due to strong light sources, etc. during dark times such as at night.

[Infrared Light Turn On Time]

Select the time to turn on the infrared illumination from [Always] or [Specify Time]. If you select [Specify Time], set the times for turning the infrared illumination on and off in [Light Turn-On Time] and [Light Turn-Off Time].

[Light Turn-On Time]

Enter the time to turn on the infrared illumination in the 24-hour format.

[Light Turn-Off Time]

Enter the time to turn off the infrared illumination in the 24-hour format.

Note

This setting may not be effective for some types of light sources, such as halogen lamps.

Installation Conditions

Configure settings for camera use suitable for the location the camera will be installed.

[LED Setting] **M50** **H76x** **H751** **M74x**

Select whether to turn on the LED indicating the camera operation status.

If you select [Turn On], the LED will light up when turning the power on, rebooting, and during normal use.

When [Turn Off] is selected, the LED will light for several seconds during startup and then turn off.

Regardless of the setting, the LED will flash when initializing the settings.

[Video Flip]

Select whether to vertically flip the video.

Select the setting suited to the camera installation method, such as ceiling mounting or placing on a desk.

Camera Position Control

Settings for camera use when there are no camera control restrictions for users or requests for camera control privileges.

[Restricted to Presets] **R1x** **M50** **H76x**

Restricts camera control of the camera angle, such as with Camera Viewer, to presets, including the home position, for users other than administrators.

[Camera Position without Control]

Select the camera operation when there are no users with camera control privileges.

If [Return to Home Position] has been selected, the home position of the camera must be set in advance with [Camera] > [Preset] > [Register Preset] (P. 131).

External Input Device 1, 2

R13 **R11** **M50** **H65x** **M641** **H761** **H751** **M741**

Enter each device name in order to identify the corresponding external input device being connected.

There are two external input device terminals on the camera.

[Device Name]

Enter the name of the device connected to the external input device terminal.

External Output Device 1, 2

R13 **R11** **M50** **H65x** **M641** **H761** **H751** **M741**

Enter each device name in order to identify the corresponding external output device being connected.

There are two external output device terminals on the camera.

[Device Name]

Enter the name of the device connected to the external output device terminal.

[Camera] > [Initial Settings] Setting Initial Video Settings

Sets initial settings, such as video quality compensation, at camera start up. If you change settings, the changes are immediately reflected in the video display area and Viewer, even if you do not click [Apply].

A message confirms whether you want to display the current camera status as the initial settings if the current camera status differs from the settings registered as the initial settings when you access [Initial Settings].

If you click [OK], the current camera status is displayed as the initial settings. If you click [Cancel], the current camera status is ignored and the settings registered as the initial settings are displayed.

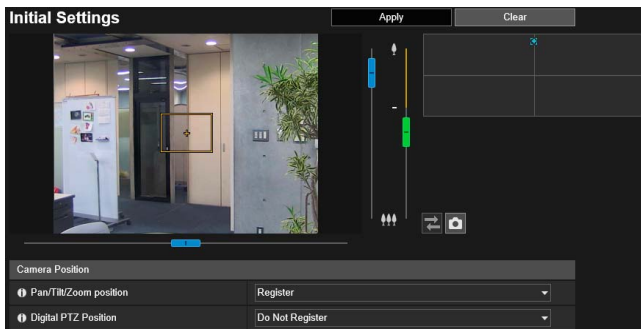

The following settings can be configured here.

- Camera Position
- Camera Settings

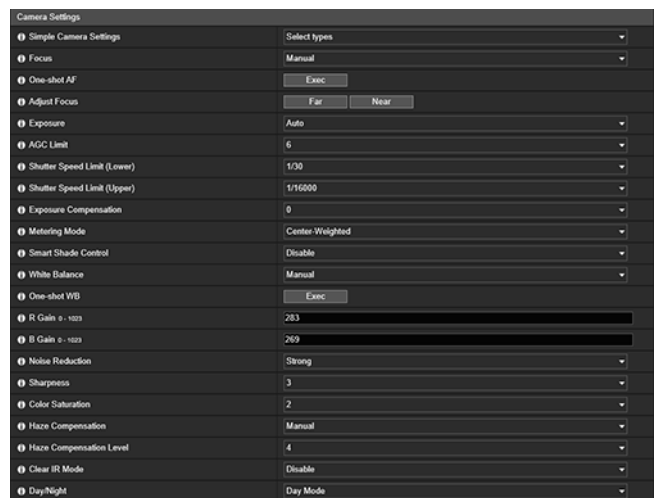

Camera Position

Sets the camera position at camera start up.

Important **R1x** **M50** **H76x**

If you change the zoom after configuring the intelligent function, privacy mask, preset, and ADSR, those settings must be configured again.

Note

After installing the camera, set the zoom position with the zoom slider in [Initial Settings]. **H751** **M74x**

[Pan/Tilt/Zoom position] **R1x** **M50**

Register the present pan, tilt, and zoom positions as the initial setting. You can operate the frame on the panorama screen or the video display area to perform pan, tilt, and zoom operations.

If you select [Do Not Register], the camera will return to the pan, tilt, and zoom positions as when the camera was turned off the next time it is booted.

Note **M50**

When [Digital PTZ Position] is set to [Do Not Register], you can perform pan, tilt, and zoom operations on the video display area using Area Zoom (P. 67).

[Zoom Position] **H76x**

Register the present zoom positions as the initial setting. If you select [Do Not Register], the camera will return to the zoom positions as when the camera was turned off the next time it is booted.

[Digital PTZ Position] **M50** **H65x** **M64x** **H76x** **H751** **M74x**

Register the current digital PTZ position as the initial setting.

If you select [Register], a yellow frame is displayed in the video display area. Operate the frame to specify the Digital PTZ trim position during startup.

 **Note** **M50** **H65x** **M64x** **H76x** **H751** **M74x**

The Digital PTZ trim frame (yellow) displayed during startup can be set to incremental sizes. The sizes that can be set are the same as the Digital PTZ of the Viewer (P. 75).

Camera Settings

Sets the camera settings at camera start up.

[Simple Camera Settings]

Recommended settings for [Camera Settings] are displayed according to the selected type (The table below shows the items and their differing recommended values) You can also change the recommended settings as required and click [Apply].

Type	Motion Priority	Depth Priority	Low Light Visibility	Data Size Reduction	Standard Settings
Usage scenario	Reduces vibrations for moving subjects.	Focuses within a wide range, from near to far.	Brightens by raising the sensitivity for dark subjects.	Reduces the data size in low-light conditions.	Cancels the scenario settings and restores the factory default settings.
[Exposure]	Auto (Shutter-priority AE)	Auto (Aperture-priority AE)	Auto	Auto	Auto
[AGC Limit]	6	6	6	4	6
[Shutter Speed Limit (Lower)]	-	1/30 (sec.)	1/8 (sec.)	1/8 (sec.)	1/30 (sec.)
[Shutter Speed Limit (Upper)]	-	1/16000 (sec.)	1/16000 (sec.)	1/16000 (sec.)	1/16000 (sec.)
[Shutter Speed]	1/1000 (sec.)	-	-	-	-
[Smart Shade Control]	Disable	Disable	Disable	Disable	Disable
[Noise Reduction]	Mild	Standard	Strong	Strong	Standard
[Sharpness]	3	6	3	3	3
[Color Saturation]	4	4	4	2	4
[Haze Compensation]	Disable	Disable	Disable	Disable	Disable

Important

Note the following regarding [Simple Camera Settings].

- [Motion Priority]: The range in which the appropriate exposure can be maintained becomes narrower. Even if you set [Day/Night] to [Auto], there are cases where the night mode may not be enabled. Flickering may occur due to fluorescent lighting, etc.
- [Depth Priority]: The range in which the appropriate exposure can be maintained may become narrower. Even if you set [Day/Night] to [Auto], there are cases where the night mode may not be enabled.
- [Low Light Visibility]: Residual images may appear for moving subjects in dark situations.
- [Data Size Reduction]: Residual images may appear for moving subjects in dark situations.

[Focus]

Selects the focus.

[Auto]

Automatically adjusts the focus.

[Manual]

You can click and hold the [Near] and [Far] buttons in [Adjust Focus] to adjust the focus in the near and far directions.

When you click [Exec] in [One-shot AF], the camera will focus once using autofocus and then switch to manual mode.

The following procedure enables you to adjust the focus appropriately.

1. Select [Auto (Aperture-priority AE)] in [Exposure], and move the aperture slider to the right limit to fully open the aperture. The depth of field becomes shallow, and you can adjust the focus appropriately.
2. To adjust the focus, click and hold the [Far] or [Near] button in [Adjust Focus], or click [Exec] in [One-shot AF].
3. When you have finished adjusting the focus, change [Exposure] to an appropriate setting.

Note H651 M64x

When using [Adjust Focus], it is recommended that you use [Adjust Focus] in [Camera Angle] > [Camera Settings] (P. 47).

[Fixed at infinity]

You can set the focus so that it is fixed near infinity.







Important

- The focus you set is also applied to other users.
- Depending on the lighting used, focus may not be maintained when switching between [Day Mode] and [Night Mode]. Focus when switching between Day/Night Mode can be set in [Camera] > [Day/Night Mode Focus].
- If you select [Manual] in [Exposure] and set the shutter speed to [1/1 sec], the camera will be out of focus if [Auto] is set. In this case, adjust the focus with [Manual].
- If you set the focus [Manual], it will remain fixed.
- In conditions where an outdoor scene is captured from an indoor location through a glass window, the camera may focus on the glass if there is dust or water on the surface. Install the camera at the shortest possible distance from the glass surface.

Note

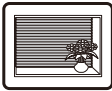
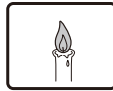
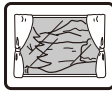
- Focusing may be difficult for the following types of subjects when using [Auto].

Difficult to Focus Subjects

 A white wall or other subject lacking bright/dark contrast	 A slanting subject	 A subject reflecting strong light
 A subject consisting of only slant lines or horizontal stripes	 A subject having no form, such as flame or smoke	 A subject seen through glass
 A fast moving subject	 A dark area or night view	 Subjects both near and far

- It is recommended that you check that the camera is focused whenever you reboot the camera.
- The estimated focus ranges depending on the [Day/Night] setting are shown in the following table.

Focus	Day/Night Settings			
	Day Mode		Night Mode	
	Max. Wide-Angle	Max. Telephoto	Max. Wide-Angle	Max. Telephoto
Auto/Manual R1x	0.3 m (12 in.) – infinity	2.0 m (6.6 ft.) – infinity	1.0 m (3.3 ft.) – infinity	2.0 m (6.6 ft.) – infinity
Auto/Manual M50	3.0 m (9.8 ft.) – infinity	5.0m (16.4 ft.) – infinity	3.0 m (9.8 ft.) – infinity	5.0m (16.4 ft.) – infinity
Auto/Manual H65x M64x H751 M74x	0.3 m (12 in.) – infinity		0.3 m (12 in.) – infinity	
Auto/Manual H76x	0.3 m (12 in.) – infinity	1.0 m (3.3 ft.) – infinity	1.0 m (3.3 ft.) – infinity	1.5 m (4.9 ft.) – infinity
Fixed at Infinity	Fixed near infinity*			

* Using infrared illumination from an external device may throw the camera out of focus.

You can use [Camera] > [Day/Night Mode Focus] > [Compensate for light source] to focus according to the wavelength of an infrared light (P. 120). **H65x M64x H751 M74x**

[One-shot AF]

Use when [Focus] is set to [Manual]. When you click [Exec], the camera will focus once using autofocus and then switch to manual.

[Adjust Focus]

If the [Focus] is set to [Manual], you can click and hold the [Near] and [Far] buttons to adjust the focus in the near and far directions.

[Exposure]

Selects an exposure mode.

Note

If [Auto] is selected in [Day/Night], select either [Auto], [Auto (Flickerless)], [Auto (Shutter-priority AE)] or [Auto (Aperture-priority AE)] for [Exposure].

[Auto]

Automatically controls the exposure.

[Auto (Flickerless)]

Automatically adjusts the shutter speed according to the brightness of the usage environment. Video flickering caused by fluorescent lights, etc., is reduced.

[Auto (Shutter-priority AE)]

Automatically adjusts the aperture and gain according to the specified [Shutter Speed].

[Auto (Aperture-priority AE)]

Automatically adjusts the gain and shutter speed according to the specified [Aperture].

[Manual]

Manually set [Shutter Speed], [Aperture], and [Gain].

Cannot be set when [Smart Shade Control] is set to [Auto].

[AGC Limit]

Select the Auto Gain Control (AGC) limit value for increasing gain to brighten video in low light conditions. The greater the value, the higher the sensitivity will become, but video noise will increase.

Important

- [AGC Limit] will not function if [Exposure] is set to [Manual] or [Auto (Flickerless)].
- Minimum subject illumination may change when [AGC Limit] is set.

[Shutter Speed Limit (Lower)]

If [Exposure] is set to [Auto], [Auto (Flickerless)], or [Auto (Aperture-priority AE)], a minimum shutter speed can be selected.

[Shutter Speed Limit (Upper)]

If [Exposure] is set to [Auto], [Auto (Flickerless)], or [Auto (Aperture-priority AE)], a maximum shutter speed can be selected.

[Shutter Speed]

If [Exposure] is set to [Auto (Shutter-priority AE)] or [Manual], you can fix the shutter speed.

Note

- Slower shutter speeds generate residual images in video when capturing a moving subject.
- When capturing a moving subject, selecting a higher shutter speed can reduce blurry video capture.

The table below describes the selectable range of shutter speed according to the setting for [Exposure].

[Exposure]	[Shutter Speed Limit (Lower)]	[Shutter Speed Limit (Upper)]	[Shutter Speed]
[Auto]	1/2 – 1/16000 (sec.)	1/2 – 1/16000 (sec.)*	-
[Auto (Flickerless)]	1/2 – 1/50 (sec.)	1/100 – 1/16000 (sec.)	-
[Auto (Shutter-priority AE)]	-	-	1/2 – 1/16000 (sec.)
[Auto (Aperture-priority AE)]	1/2 – 1/16000 (sec.)	1/2 – 1/16000 (sec.)*	-

[Exposure]	[Shutter Speed Limit (Lower)]	[Shutter Speed Limit (Upper)]	[Shutter Speed]
[Manual]	-	-	1/1 – 1/16000 (sec.)

* You cannot select a speed lower than [Shutter Speed Limit (Lower)].

Important

- If a traffic signal, electronic scoreboard, etc. is captured the video may flicker. In this case, try changing [Exposure] to [Auto (Shutter-priority AE)] and then select a shutter speed lower than 1/100 seconds so that the condition improves.
- Setting a slow shutter speed may prevent the intelligent function from working correctly. Select a shutter speed that suits the capture conditions and purpose.

[Aperture]

If [Auto (Aperture-priority AE)] or [Manual] is selected for [Exposure], set a desired aperture.

Moving the slider to the left closes the aperture and darkens the image. Moving the slider to the right opens the aperture and brightens the image.

[Gain]

If [Manual] is selected for [Exposure], set the sensitivity to affect brightness.

Moving the slider to the left darkens the video, and moving it to the right brightens video.

[Exposure Compensation]

When [Exposure] is set other than [Manual], you can adjust the brightness of the video by selecting the [Exposure Compensation].

Important

The setting is not available if [Smart Shade Control] is set to [Auto].

[Metering Mode]

When [Exposure] is set a value other than [Manual], you can select a metering mode.

[Center-Weighted]

Performs photometry with the entire screen center-weighted.

Even if there is a slight difference in light and dark around the screen, subjects near the center will have the appropriate exposure.

Use this when the subject is near the center of the screen.

[Average]

Performs photometry with the average of the entire screen.

This enables stable exposure to be obtained even in environments with large differences in light and dark on the screen. Use this to stabilize the exposure for scenes when cars are passing or people are entering and exiting.

[Spot]

Performs photometry with the center of the screen.

This enables the appropriate exposure to be obtained for subjects in the center of the screen, regardless of differences in light and dark around the screen.

Use this to match the exposure with the center of the screen when the subject is hit by spotlights or backlit.

[Smart Shade Control]

If the background is bright and the subject is hard to see, this function brightens dark areas without affecting bright areas to make the subject easier to see.

This is different from Backlight Compensation (P. 71). This function suppresses over-exposure of highlights while compensating for under-exposure in dark areas of the video.

Important

- [Auto] cannot be selected for [Smart Shade Control] if [Exposure] is set to [Manual].
- [Smart Shade Control] is not available if [Haze Compensation] is set to [Auto] or [Manual].

[Manual]

Set the level of compensation in [Smart Shade Control Level].

[Auto]

Performs automatic control with both smart shade control function and exposure compensation functions to prevent blocked up under-exposure and over-exposure.

[Smart Shade Control Level]

When [Smart Shade Control] is set to [Manual], set a compensation level.

Note

- The video data size increases if you set [Auto] or [Manual] for [Smart Shade Control].
- Screen noise may increase if you set [Smart Shade Control] to [Manual] and the control level to strong. Set the control level to mild to reduce the noise.

[White Balance]

Select the white balance according to the light source to achieve natural color in the video.

Important

- When the subject has only one color, is under low light conditions, or when sodium lamps, mercury lamps or certain other fluorescent lighting is used, [Auto] may not adjust colors appropriately.
- If [Auto] is set, and the subject appears greenish under mercury lamps, select [Mercury Lamp]. If the colors of the screen are not appropriate under a mercury lamp even when you select [Mercury Lamp], select [Manual] and use [One-shot WB].
- Since the light source selection options are based on representative characteristics, appropriate colors may not be achieved depending on the available light source. If this occurs, select [Manual] and use the [One-shot WB].

[Auto]

Automatically adjusts the white balance.

[Manual]

Operate [One-shot WB], [R Gain], and [B Gain] to manually set the white balance.

[Daylight Fluorescent] (approx. 6,100K - 6,600K)

Select this when capturing under a daylight fluorescent lamp.

[White Fluorescent] (approx. 4,100K - 5,000K)

Select this when capturing under a daylight fluorescent lamp or white fluorescent lamp.

[Warm Fluorescent] (approx. 2,500K - 3,000K)

Select this when capturing under a warm fluorescent lamp.

[Mercury Lamp] (approx. 4,300K)

Select this when capturing under a mercury lamp.

[Sodium Lamp] (approx. 2,000K)

Select this when capturing under an orange sodium lamp.

[Halogen Lamp] (approx. 2,700K - 3,200K)

Select this when capturing under a halogen lamp or incandescent lamp.

[One-shot WB]

If you set white balance to [Manual], this will force the white balance to match the light source and lock the setting.

Setting Method Example:

Illuminate a white subject (white paper, etc.) using the light source, making sure the subject fills the entire screen, and then click [Exec].

[R Gain]

If you set white balance to [Manual], set the Red gain values.

[B Gain]

If you set white balance to [Manual], set the Blue gain values.

Important

- When [Clear IR Mode] is set to [Enable], the setting of [White Balance] cannot be changed. **M50 H761**
- When [Day/Night] is set to [Night Mode] (including when it is set to [Auto] and Night Mode is judged to be applicable), the white balance function cannot be used.
- If a subject that seldom changes is captured in a location where the light source changes gradually, such as when capturing a subject continuously day and night, appropriate colors may not be achieved. In this case, appropriate colors can be achieved by changing the captured video with settings such as [One-shot WB].

[Noise Reduction]

Select a noise reduction level. This setting is generally more effective in low-light conditions.

When set to [Strong], the noise reduction effect is increased, but residual images are more likely to appear.

When set to [Mild], the noise reduction effect is decreased and resolution is increased, but the video file size becomes larger.

[Sharpness]

Select a sharpness level.

When set toward [Strong] the video becomes sharper, and when set toward [Mild] the video becomes softer.

When set toward [Strong] the video file size becomes larger.

[Color Saturation]

Select a color saturation level.

[Haze Compensation]

If the subject is obscured by haze, this adjusts contrast in the video to improve subject visibility.

[Manual]

Set the level of compensation in [Haze Compensation Level].

[Auto]

Automatically performs haze compensation. Select the compensation strength in [Haze Compensation Strength (Auto)] (P. 108).

Important

[Haze Compensation] cannot be used if [Smart Shade Control] is set to [Auto] or [Manual].

Note

- When [Auto] or [Manual] is selected for [Haze Compensation], the video data size may increase.
- If using [Haze Compensation] causes a strong difference in video brightness, set [Haze Compensation] to [Manual] and set [Haze Compensation Level] weaker.

[Haze Compensation Level]

When Haze Compensation is set to [Manual], set the compensation level.

[Clear IR Mode] **M50 H761**

Uses infrared light to reduce shade and heat shimmer in far backgrounds to make the video clearer.

If you select [Enable], the video becomes black and white.

Important **M50 H761**

- Since video is captured using infrared light, the video may be affected in the following ways. Confirm the effectiveness before use.
 - Red colors may appear white.
 - Leaves of plants may appear white.
 - Water surfaces may appear black.
- The effect may differ depending on the weather.
- Since performance decreases in low-light conditions, use Night Mode in dark situations.

Note **H761**

You can set the time to turn on the infrared illumination in [Camera] > [Clear IR Mode] (P. 110).

[Day/Night]

Select a capture mode according to the brightness of the installation environment.

[Auto]

The camera automatically determines ambient brightness and switches to Day Mode or Night Mode.

[Day Mode]

Captures normal color video.

[Night Mode]

Removes the infrared filter to increase sensitivity. Video turns to monochrome.

 Important

- [Day/Night] cannot be set if [Clear IR Mode] is set to [Enable]. **M50 H761**
- If you use [Auto], conduct a thorough operation test beforehand to check the effectiveness of the setting.
- When [Auto] is selected, set [Exposure] to [Auto], [Auto (Flickerless)], [Auto (Shutter-priority AE)], or [Auto (Aperture-priority AE)]. However even if you set [Day/Night] to [Auto], the night mode may not be enabled, depending on the shutter speed when [Auto (Shutter-priority AE)] is set or depending on the aperture when [Auto (Aperture-priority AE)] is set.
- If you exit the Viewer while [Day Mode] or [Night Mode] is set, these will remain in effect, even if [Day/Night] is set to [Auto] on the Setting Page.
To enable [Auto] Day/Night Mode, set [Day/Night] to [Auto] before exiting the Viewer.
- If you use [Auto], the infrared filter may move several times while the mode is switching between Day Mode and Night Mode. You will not be able to use pan, tilt, zoom and manual focus during this period.
- If you use infrared illumination from an external device in Night Mode, turn on the infrared illumination before switching to Night Mode.

[Use Infrared Light] **H652 H761 H751 M741**

Select whether to use infrared illumination operated with [Day/Night].

[Day/Night Operation]

Linked to Day/Night. Turns on infrared illumination in Night Mode.

[Disable]

Infrared illumination is not used.

 Important **H761**

[Use Infrared Light] cannot be set if [Clear IR Mode] is set to [Enable].

 Note

- If all or part of the image appears to have a white glow, there is a possibility that a wall (even a wall not in the image) is reflecting the infrared lighting. If this occurs, please adjust the camera angle. **H652 H761 H751 M741**
- If you use the Sunshade Cover (sold separately) in conjunction with infrared illumination, switching between day/night using [Day/Night] > [Auto] may not be possible due to the angle of the lens. In this case, adjust the angle of the lens (please refer to "Installation Guide"), or configure [Day/Night Mode Switching] using [Timer] (P. 170). **H652**
- The range of the infrared illumination differs depending on the power source used (refer to the "Appendix – Specifications").

[Infrared Light Level] **H652 H761 H751 M741**

Sets the infrared illumination strength when [Day/Night Operation] is selected in [Use Infrared Light].

 Important

[Infrared Light Level] can only be set when [Exposure] is set to [Manual].

[Camera] > [Day/Night Mode Focus] Day/Night Mode Focus

Set the focus position when switching day/night. It is necessary to change the focus position since the wavelengths of regular lighting such as fluorescent lamps and infrared lighting differ.

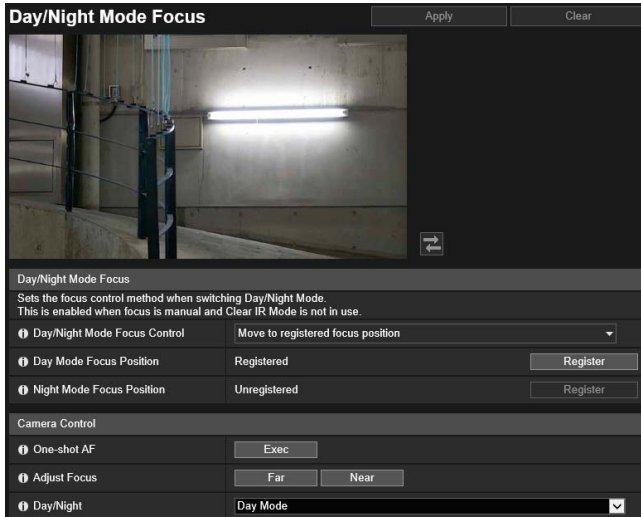

The following settings can be configured here.

- Day/Night Mode Focus
- Camera Control

Important

Even if you use [Day/Night Mode Focus] with the night mode, the camera may be out of focus due to changes in the light source (when sunlight mixes with infrared lighting, etc.).

Note

You can set [Day/Night Mode Focus] if the following conditions have been met.

- When [Focus] (P. 113) is set to [Manual]
- When [Clear IR Mode] (P. 118) is set to [Disable] **M50** **H761**

Day/Night Mode Focus

[Day/Night Mode Focus Control]

Set the focus control method when switching day/night.

[Use One-shot AF]

Select this to use One-shot AF when switching Day/Night Mode.

Important

When using [Use One-shot AF] and switching between Day/Night Mode, it may not be possible to focus on the intended subject if another subject, such as a person, passes in front of the camera.

[Move to registered focus position]

When switching Day/Night Mode, the focus positions preregistered in [Day Mode Focus Position] or [Night Mode Focus Position] will be used. For more information, please refer to “Registering a Focus Position”.

[None] **R1x** **M50** **H76x**

When switching Day/Night Mode, the camera automatically focuses on each of the fluorescent lighting focus positions set beforehand for Day Mode and Night Mode.

[Compensate for light source] **H65x** **M64x** **H751** **M74x**

Adjust the focus position to suit the light source when switching to Night Mode.

[Light Source] **H65x** **M64x** **H751** **M74x**

If you selected [Compensate for light source], select the light source.

[Fluorescent]

Select this option to capture video under fluorescent, LED, sodium or mercury lighting.

[Halogen Lamp]

Select this option to capture video under halogen or incandescent lighting.

[Infrared Light (740nm)]

Select this option to capture video under infrared (740 nm wavelength) illumination.

[Infrared Light (850nm)]

Select this option to capture video under infrared (850 nm wavelength) illumination.

[Infrared Light (940nm)]

Select this option to capture video under infrared (940 nm wavelength) illumination.

■ Registering a Focus Position

If you selected [Move to registered focus position] for [Day/Night Mode Focus Control], register a focus position.

- 1** In [Camera Control], select [Day Mode] for [Day/Night].
- 2** Use [One-shot AF] or [Adjust Focus] in [Camera Control] while viewing the video display area to adjust the camera to a suitable focus position under the lighting conditions of day mode.
- 3** Click [Register] for [Day Mode Focus Position].
[Registered] is displayed for [Day Mode Focus Position].
- 4** In [Camera Control], change [Day/Night] to [Night Mode].
- 5** Repeat steps 2 and 3 to register the focus position under the Night Mode lighting conditions.
- 6** Click [Apply].
The settings are saved to the camera.

Note

- If you select an item other than [Move to registered focus position] without first clicking [Apply], the focus position returns to [Unregistered].
- Click [Clear] to set the focus position again. The focus position setting is discarded and the setting saved in the camera is restored.
- See the page (P. 114) for the focus ranges when using Day/Night Mode settings.

Camera Control

Set the camera focus adjustment and day/night capture mode when controlling day/night mode focus.

[One-shot AF]

Use when [Move to registered focus position] is selected in [Day/Night Mode Focus Control]. When you click [Exec], it will focus once using autofocus and then switch to manual mode.

[Adjust Focus]

Use when [Move to registered focus position] is selected in [Day/Night Mode Focus Control]. Click [Far] and [Near] to adjust focus.

[Day/Night]

Set a capture mode suited to the brightness of the camera installation environment.

[Auto]

The camera automatically determines ambient brightness and switches to Day Mode or Night Mode.

[Day Mode]

Captures normal color video.

[Night Mode]

Removes the infrared filter to increase sensitivity. Video turns to monochrome.

[Camera] > [Panorama] Creating a Panorama Image

R1x M50

You can create a panorama image that captures the entire area that can be captured by the camera. Created panorama images are displayed in the Viewer and part of the Setting Page.

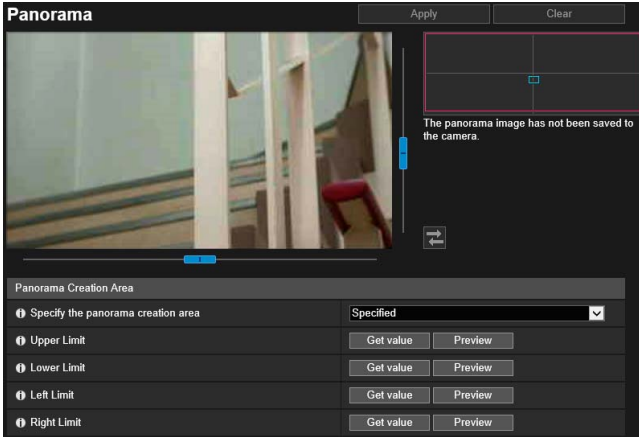

The following settings can be configured here.

- Panorama Creation Area
- Panorama Image
- Capture Settings

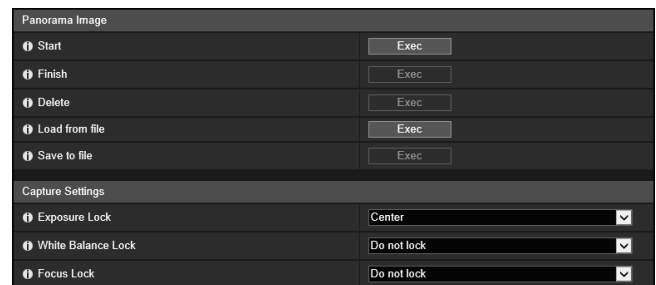

Important

- If you change the privacy mask settings in [Privacy Mask], it is recommended that you create the panorama image again to reflect the new privacy mask settings in the panorama image.
- If you have changed the camera installation method settings, recapture the panorama image.

Creating a Panorama Image

A panorama image can be used in the Viewer and for a privacy mask by clicking [Apply] to save it to the camera after capturing.

Note

- While a panorama image is being captured, the Image Stabilizer is temporarily disabled.
- The following users will be disconnected while creating a panorama image.
 - All users except for administrators
 - Users not connected via RTP
- When a small value is entered for [Maximum Frame Rate: Video Transmission] (P. 103) in [Video] > [JPEG], panorama capture is slowed down.

1 Set [Panorama Creation Area]

Set the range for panorama creation. This enables the panorama creation time to be reduced.

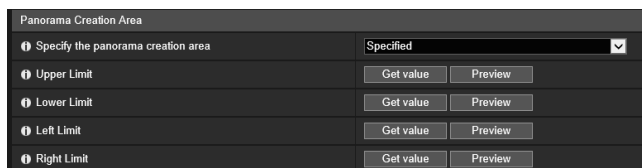

[Specify the panorama creation area]

If you select [Specified], the panorama image is created within a set area that can be captured by the camera. If you select [Not specified], the panorama image is created within the entire area that can be captured by the camera.

If you selected [Not specified], proceed to step 3.

2 Set the panorama creation area using the video display area.

Operate the camera angle to get the positioning value in the video display area, and specify the panorama creation range.

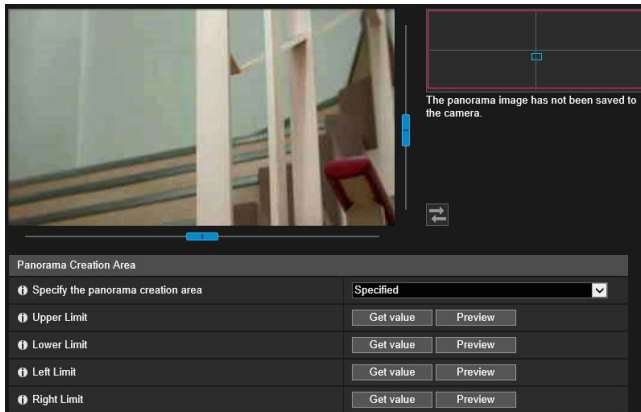

[Upper Limit]/[Lower Limit]/[Left Limit]/[Right Limit]

Operate the camera angle to the upper limit, lower limit, left limit, and right limit to set in the video display area. Click [Get value] in each position to reflect the values to the panorama creation range frame.

Click [Preview] in [Upper Limit]/[Lower Limit]/[Left Limit]/[Right Limit] to move the preview frame to the upper limit, lower limit, left limit, and right limit of the current panorama creation range frame and display it in the video display area.

Two types of frames are displayed for panorama images.

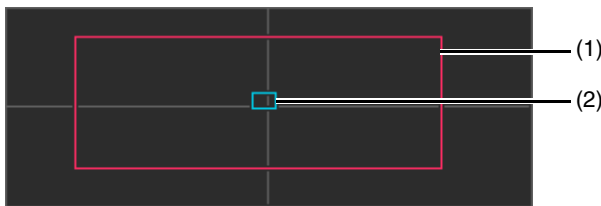

(1) Panorama creation area frame (red frame)

Indicates the capture area of the panorama image. You can also drag the panorama creation area frame to set the capture range for the panorama image.

Note

If the preview frame is positioned outside the panorama creation area frame you have changed, the camera position is moved inside the panorama creation area frame.

(2) Preview frame (blue frame)

Indicates the current position displayed in the video display area.

3 Set [Capture Settings] as necessary.

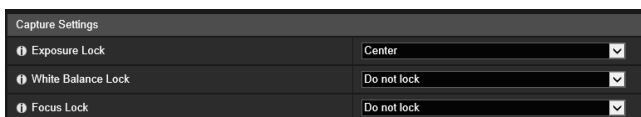

For details on the settings, please refer to "Capture Settings" (P. 126).

[Capture Settings] are applied when panorama capture is started, and the previous settings are restored after panorama capture is complete.

4 In [Start], click [Exec].

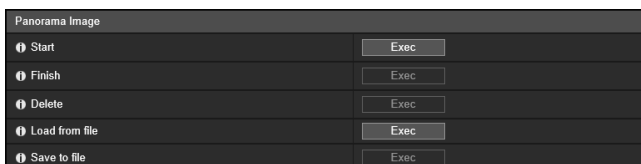

Capturing starts, and the panorama image is created.

Click [Cancel] to cancel capturing.

To recapture part of the image:

A lattice frame is displayed on the created panorama image.

Right-click with the mouse pointer over the area to recapture and select [Recapture] to recapture that area only.



To capture the entire panorama image again:

Click [Exec] of [Start] again.

5 In [Finish], click [Exec].

The created image is not yet saved in the camera.

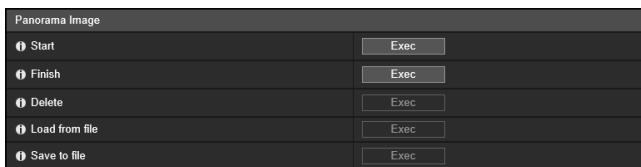

6 Click [Apply].

The panorama image is saved in the camera and reflected in the other settings.

■ Deleting a Panorama Image from the Camera

You can delete a panorama image saved in the camera.

1 Click [Exec] of [Delete].

The displayed panorama image is cleared.

2 Click [Apply].

The confirmation message is displayed.

3 Click [OK].

The panorama image saved in the camera is deleted.

Saving the Panorama Image as an Image File/Opening the Image File

The captured panorama image can be saved as an image file and image files can be opened as panorama images. Only image files in the JPEG format can be used.

Saving the Panorama Image as an Image File

1 After creating the panorama image, click [Exec] in [Save to file].

2 In the displayed dialog box, select the folder to save the file in, and enter the file name.

3 Click [Save].

The image file is saved in the specified location.

Opening the Image File

- 1** In [Load from file], click [Exec].
- 2** In the displayed dialog box, select the image file to use and click [Open].
The panorama image is displayed.

Capture Settings

These settings will be applied at the panorama image capture start time and will revert back to their previous settings once capture is completed.

[Exposure Lock]

The exposure for the selected position will be automatically adjusted and locked during capture.

[White Balance Lock]

The white balance for the selected position will be automatically adjusted and locked during capture.

[Focus Lock]

The focus for the selected position will be automatically adjusted and locked for the entire scene during capture.

[Camera] > [View restriction] Setting View Restriction

R1x M50 H76x

Set the range that the camera can capture.

You can use this, for example, to limit zoom or the angle of view to a certain range when publishing live video.

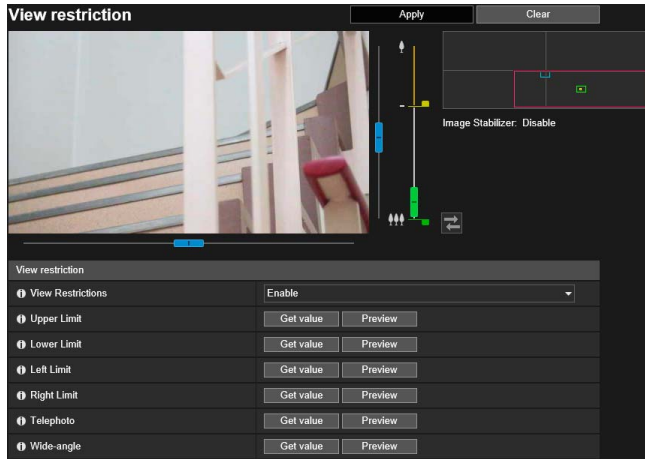

The following settings can be configured here.

- View restriction

5

Setting Page

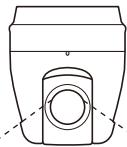

View restriction

Recording outside the view restriction is not possible.

Scope of View Restriction Settings

Restrictions set by the view restriction function are applied in the following cases.

- When the Camera Viewer is accessed with authorized user or guest user privileges.
- When accessed via RM-Lite.
- For presets or functions that move to preset positions.

Note

Even when view restrictions are set, an area outside the view restriction may still be displayed momentarily when the camera is controlled near the boundary of the view restriction.

Configuring View Restrictions

Set a restrict view area and click [Apply] to restrict the capture range of the Camera Viewer.

Important

- If you have changed how the camera is installed, reconfigure the view restriction settings.
- Check view restrictions again if you change the [Basic] > [Video] > [All Videos] > [Video Size Set] settings on the Setting Page.
- When [Camera] > [Camera] > [Camera Control] > [Digital Zoom] or [Image Stabilizer] is changed on the Setting Page, check the view restriction settings again.

1 Select [Enable] in [View Restrictions].

Note

To delete view restriction settings, select [Disable], and click [Apply].

2 Set the restrict view area using the frame on the video display area or the panorama screen/full-view screen.

Operate the camera angle using the frame on the video display area or the panorama screen/full-view screen to get the positioning value, and specify the restrict view area.

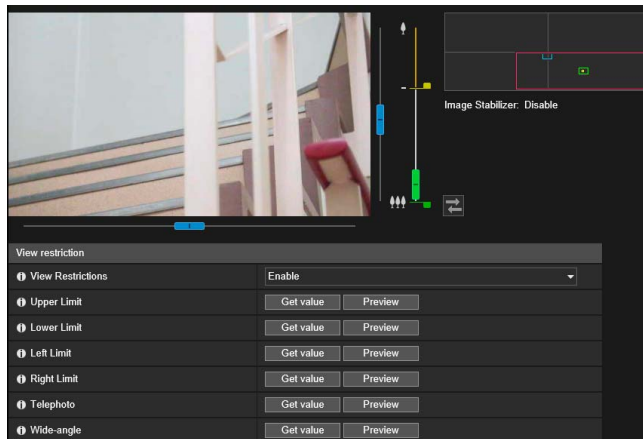

[Upper Limit]/[Lower Limit]/[Left Limit]/[Right Limit] **R1x** **M50**

Operate the camera angle to the upper limit, lower limit, left limit, and right limit to set in the video display area. Click [Get value] in each position to reflect the values to the pan/tilt preview frame.

Click [Preview] in [Upper Limit]/[Lower Limit]/[Left Limit]/[Right Limit] to move the preview frame to the upper limit, lower limit, left limit, and right limit of the current pan/tilt preview frame, respectively, and display it in the video display area.

Note **R1x**

In the following cases,  (warning icon) will be displayed with a message stating that the restrict view area cannot be configured, and you will become unable to set view restrictions.

- For [Left Limit]/[Right Limit]: If [Camera] > [Camera Control] > [Auto Flip] (P. 108) is set to [Enable]
- For [Upper Limit]: If [Camera] > [Camera Control] > [Auto Flip] (P. 108) is set to [Enable], and [Camera] > [Installation Conditions] > [Video Flip] (P. 110) is also set to [Enable]
- For [Lower Limit]: If [Camera] > [Camera Control] > [Auto Flip] (P. 108) is set to [Enable], and [Camera] > [Installation Conditions] > [Video Flip] (P. 110) is set to [Disable]

To set the upper limit, lower limit, left limit, and right limit, set [Camera] > [Camera] > [Camera Control] > [Auto Flip] (P. 108) to [Disable].

[Telephoto]/[Wide-angle]

Operate the camera angle to the wide-angle/telephoto limit to set, using the frame on the video display area or the panorama screen.

Click [Get value] in each position to reflect the values to the wide-angle preview frame/telephoto preview frame. Click [Preview] in [Telephoto]/[Wide-angle] to move the preview frame to the telephoto/wide-angle limit of the current wide-angle preview frame/telephoto preview frame and display it in the video display area.

You can also set the telephoto/wide-angle limit range by directly moving the operation knob on the zoom slider up

and down. This also moves each preview frame to the telephoto/wide-angle limit of the current wide-angle preview frame/telephoto preview frame and displays it in the video display area.

If you dragged the telephoto knob to the upper limit and the wide-angle knob to the lower limit, the view restriction is disabled for each edge (there is no restriction).

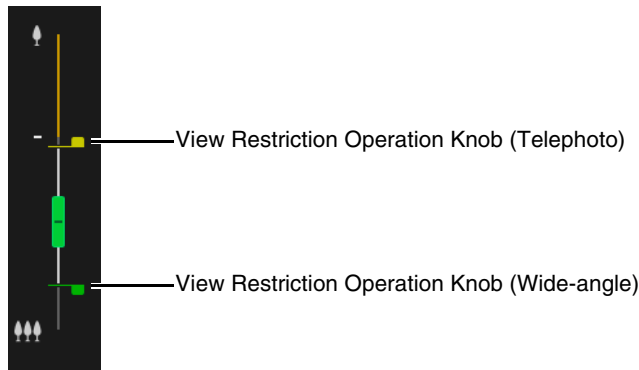

Drag the frames displayed on the panorama screen to set the restrict view area.

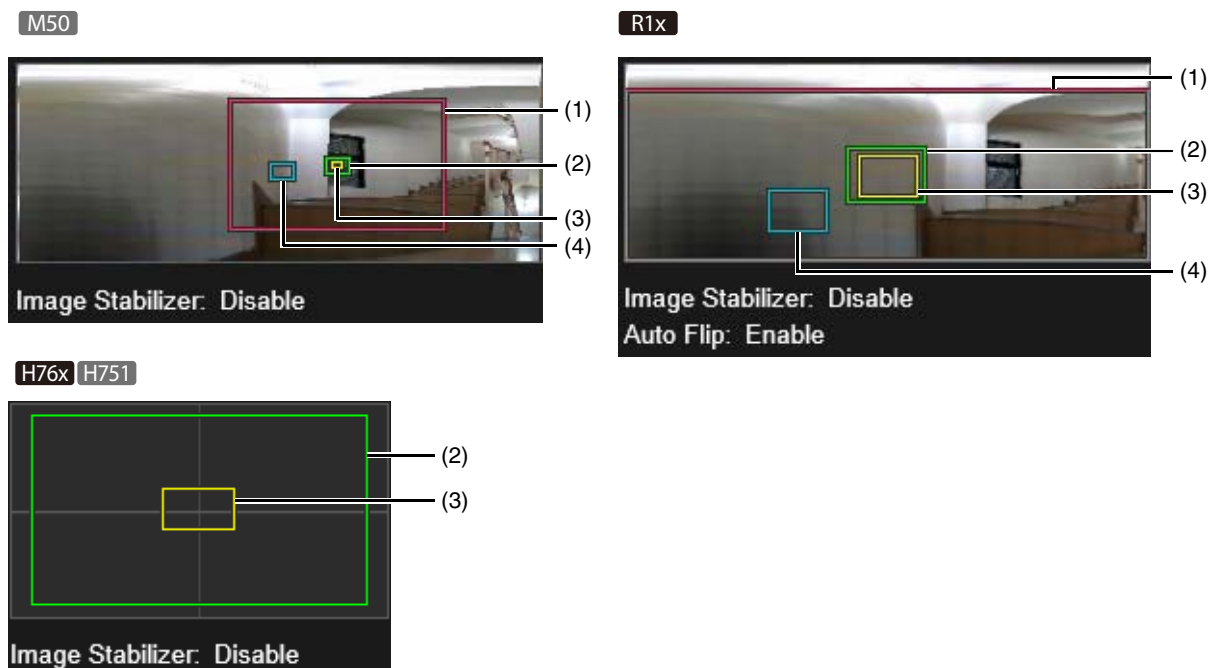

(1) **Pan/Tilt Preview Frame (Red Frame)** **R1x** **M50**

Displays the vertical and horizontal range the camera can move. You can directly change the restrict view area by dragging the pan/tilt preview frame.

If you dragged the pan/tilt preview frame to the outer frame of the panorama area, the view restriction is disabled for each edge (there is no restriction).

Note **R1x**

If [Camera] > [Camera Control] > [Auto Flip] (P. 108) is set to [Enable], sides of the pan/tilt preview frame that cannot be configured become gray and cannot be changed. For information on the relationship between Auto Flip and configuring the restricted view area, please refer to "Note" on P. 128.

(2) **Wide-Angle Preview Frame (Green Frame)**

You can directly change the maximum wide-angle view by dragging the wide-angle preview frame, but the aspect ratio cannot be changed.

The wide-angle preview frame can be set within the pan/tilt preview frame. **R1x** **M50**

(3) **Telephoto Preview Frame (Yellow Frame)**

You can directly change the maximum telephoto view by dragging the telephoto preview frame, but the aspect ratio cannot be changed.

The telephoto preview frame can be set within the wide-angle preview frame.

(4) **Preview Frame (Blue Frame)** **R1x** **M50**

Indicates the current position displayed in the video display area.

Note

- If the preview frame (blue frame) is positioned outside the pan/tilt preview frame (red frame) you have changed, the camera position is moved inside the restricted view. **R1x M50**
- If you change the position of the wide-angle/telephoto preview frame, the wide-angle/telephoto end of the preview frame is also changed.

3 Click [Apply].

The settings are saved to the camera.

Important **R1x M50**

The panorama screen may vary from the actual image. After you have configured view restrictions, be sure to use the Camera Viewer to confirm the changes have been reflected correctly. View restrictions are not applied to the video display area of the restrict view setting.

Note **R1x M50**

- The controllable range and range that can be captured are as follows.

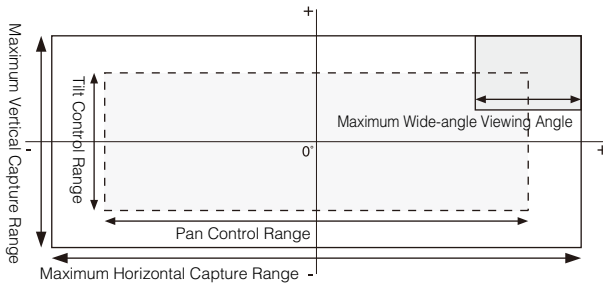

- The pan and tilt ranges vary depending on the zoom ratio (view angle).

Setting view restrictions automatically restricts the camera operating angle.

When using wide-angle, the camera operating angle would allow capture outside the view restrictions if the angle remained the same. Therefore, it is narrowed automatically.

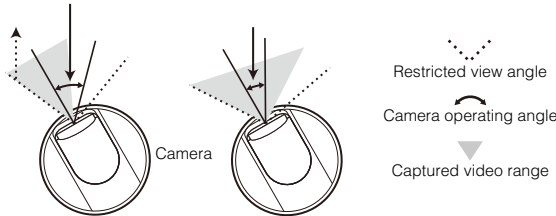

- If the view restriction will be exceeded as a result of zooming toward wide-angle, the camera will first pan and tilt to a position where the maximum wide-angle zoom will be within the viewing restriction area. Wide-angle zoom control will then be enabled within the view restriction area.

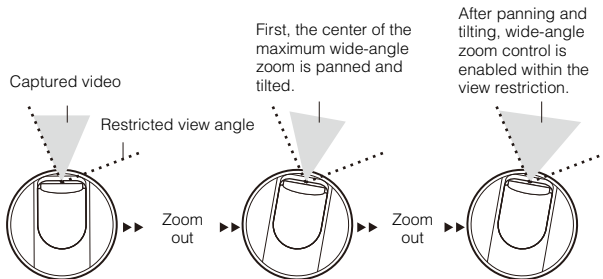

- Narrowing the view restriction may also reduce the zoom range.

[Camera] > [Preset] Registering Presets

By registering settings as presets, such as camera angles, camera settings (e.g. exposure) and Day/Night Mode switching, the presets can be easily called up by Viewers to apply the settings.

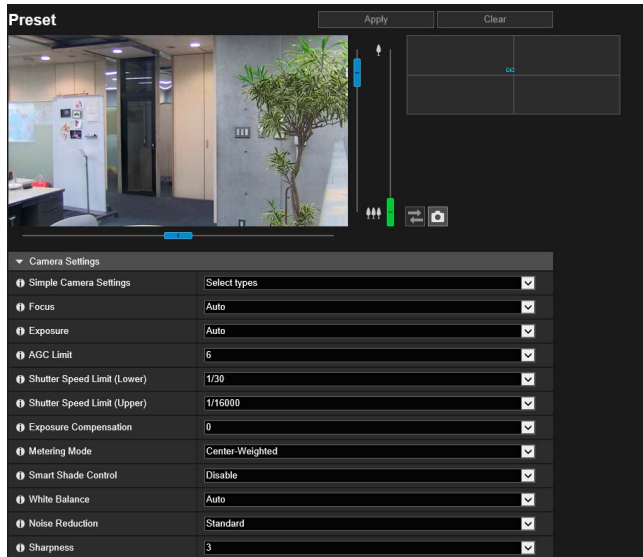

The following settings can be configured here.

- Camera Settings
- Register Preset

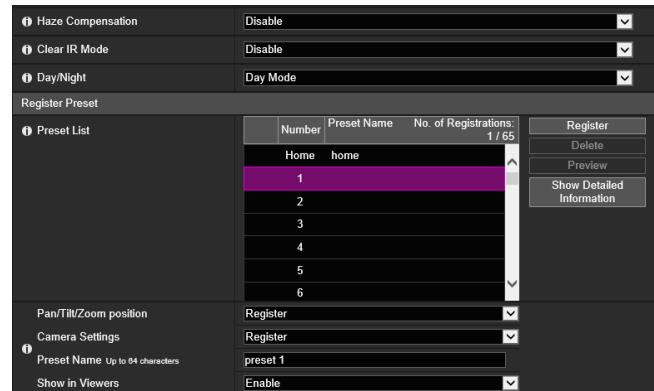

Important

- It is strongly recommended you register as presets, the positions Intelligent Function will use for the camera. **R1x M50 H76x**
- If you use a preset registered with the digital zoom, the camera position at registration may not be able to be reproduced with a high degree of accuracy. Therefore, it is recommended that you use a preset registered in the optical zoom area for the preset tour and intelligent function. **R1x M50 H76x**
- Reconfigure the presets if you change the [Camera] > [Camera] > [Installation Conditions] > [Video Flip] (P. 110) settings on the Setting Page.
- Reconfigure the presets if you change [Video] > [All Videos] > [Video Size Set] (P. 102) settings on the Setting Page.
- If you change the settings in [Camera] > [Camera Control] > [Image Stabilizer] on the Setting Page (P. 108), the angle of view when using the camera will not match the angle of view when you configured presets. If you change [Image Stabilizer] settings, recheck the preset settings.

Using Presets

In addition to immediate execution of registered camera angles and the camera settings such as exposure when operating the viewer, you can use presets as follows.

- Execute the presets during switches between Day Mode and Night Mode (P. 201).
- Automatically cycle through multiple presets at a set time and in a predetermined sequence (Preset Tour) (P. 135).
- When using the Intelligent Function, lock the monitoring position at a preset camera angle (P. 177).

R1x M50 H76x

Registering a Preset

The camera angle and camera settings can be registered as a preset.

The number of presets you can register are as follows.

- Maximum 257 presets (including the home position). **R1x**
- Maximum 65 presets (including the home position). **M50**
- Maximum 21 presets (including the home position). **H65x M64x H76x H751 M74x**

1 Operate the panorama image to set the angle you want to register as the preset.

The camera angle can also be operated from the following screens.

Panorama screen **R1x** **M50** **H76x**

Digital PTZ panel **H65x** **M64x** **H751** **M74x**

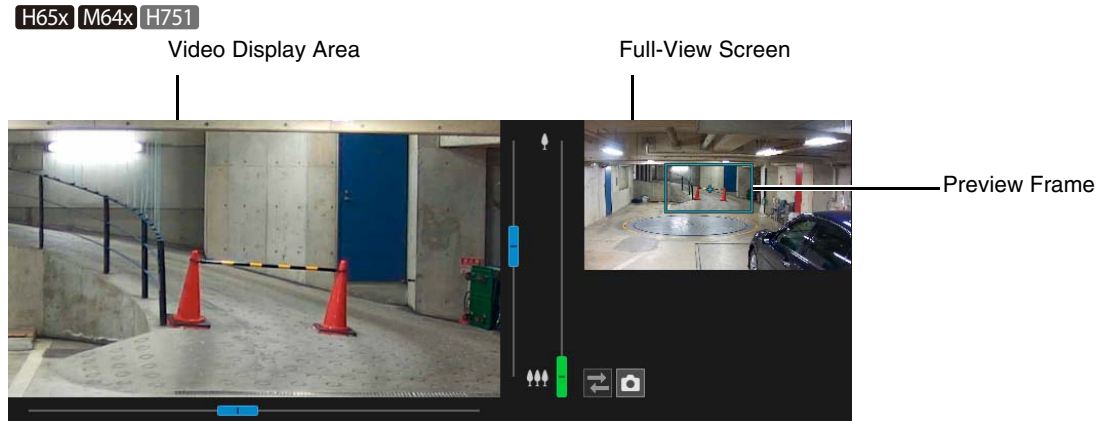
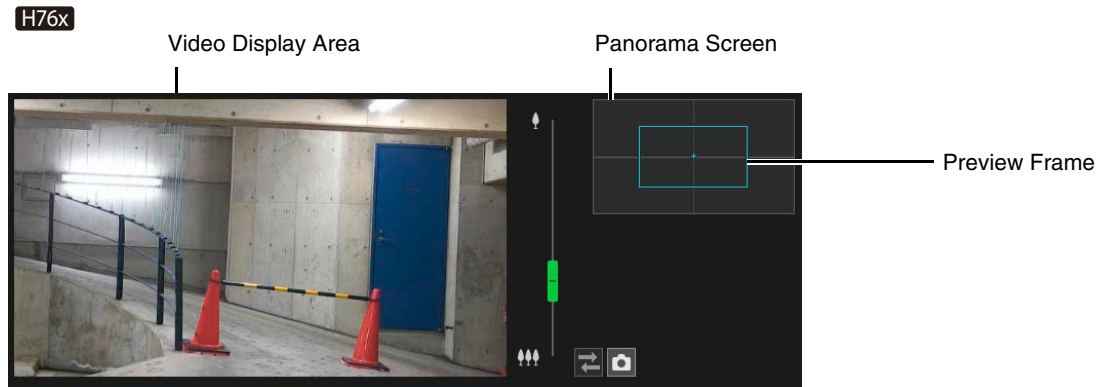
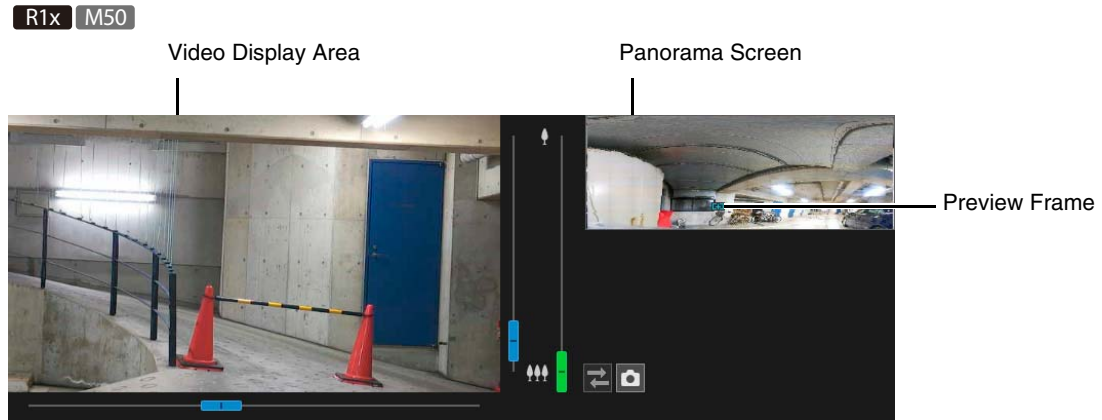

2 Click [Camera Settings] to set the items as necessary.

Set the items to apply in the preset. For a description of each item, please refer to "Camera Settings" (P. 113).

3 Set the items of preset registration.

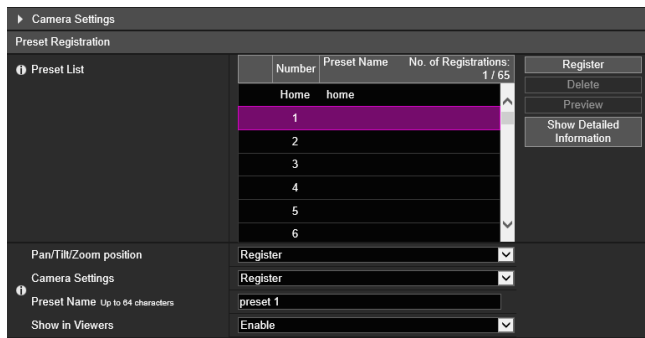

[Pan/Tilt/Zoom position] **R1x** **M50** / [Zoom Position] **H76x** / [Digital PTZ Position] **H65x** **M64x** **H751** **M74x**
 Select [Register] to register the current camera angle as a preset.

Note

If you selected [Home] (home position) in the preset list, [Pan/Tilt/Zoom position]/[Zoom Position]/[Digital PTZ Position] is always registered.

[Camera Settings]

Select [Register] to register the current camera settings as a preset.

[Preset Name]

Enter a preset name. Be sure to enter a preset name in [Preset Name].

[Show in Viewers]

Select [Enable] to allow the Camera Viewers to use the preset.

4 Click [Register].

Note **R1x** **M50** **H76x**

If the preset position is outside the restrict view area,  (a warning icon) is displayed on the left.

5 To register multiple presets, repeat steps 1 – 4.

6 Click [Apply].

The preset is saved in the camera.

Note

Click [Clear] to discard the settings and restore the settings saved in the camera. However, note that presets only registered to the preset list by clicking [Register] are all discarded.

■ Deleting a Preset

Select the preset to delete in the preset list, and click [Delete]. Click [Apply] to delete the preset from the camera. [Home] (home position) cannot be deleted.

■ Previewing a Preset

Select a preset in the preset list, and click [Preview]. The preset settings are displayed in the video display area.

■ Checking Advanced Preset Information

Displays the information of the presets registered in the camera.

Select the preset to check the advanced information from the preset list, and click [Show Detailed Information].

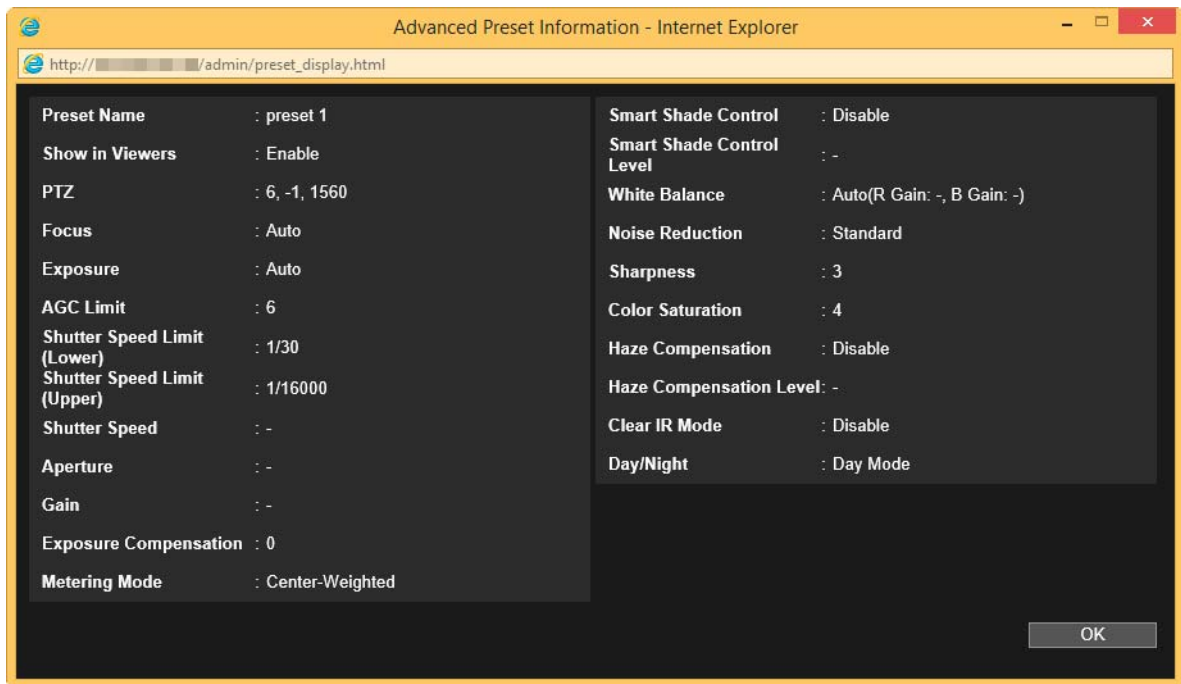

Check the detailed information, and click [OK].

[Camera] > [Preset Tour] Setting the Preset Tour Route

You can have the camera automatically tour multiple registered presets to allow monitoring.

Preset Tour Apply Clear

Preset Tour

Setting routes that frequently use the camera's pan/tilt capabilities, can reduce the lifespan of the camera's pan/tilt mechanism.

Route List

Route Name	Conditions to Enable Settings	Active Time hh:mm-hh:mm	Revert
route 1	Viewers Connected	Not Specified	No
route 2	Disable	Not Specified	No
route 3	Disable	Not Specified	No
route 4	Disable	Not Specified	No
route 5	Disable	Not Specified	No

Conditions to Enable Settings: Viewers Connected
 Route Name: Up to 64 characters
 Specify Active Time: Not Specified
 Reverse Route: Disable

The following settings can be configured here.

- Route List
- Edit Tour Route

Edit route 1 Tour Route No. of Registrations: 0 / 60

Number	Preset Name	Speed (PT, Z)	Pause Duration

Speed (PT): 20(Fast)
 Speed (Z): 8(Fast)
 Pause (sec) 0-3600: 0

Important R1x M50

- If you set frequent pan/tilt operations in a preset tour, the life expectancy of the pan/tilt drive part may become shorter. The life expectancy may become even shorter in environments outside ordinary temperatures (approx. 23°C (73°F) and approx. 60% humidity).
You can reduce the frequency of pan/tilt operations by setting a longer stop time at each tour point, or by specifying an active time for the preset tour to reduce operation time.
- Intelligent Function cannot be used while using preset tour.

Note

- Preset tour is not performed while the camera control privileges are obtained in the Camera Viewer or the video is displayed on the Setting Page.
- Preset tour is not performed when control privileges are obtained by RM-Lite.

Screen Composition

The screen composition differs according to the camera model, because the number of tour routes that can be registered, number of presets that can be toured with a single route, and tour conditions differ.

Route List

Route Name	Conditions to Enable Settings	Active Time hh:mm-hh:mm	Revert
route 1	Viewers Connected	Not Specified	No
route 2	Disable	Not Specified	No
route 3	Disable	Not Specified	No
route 4	Disable	Not Specified	No
route 5	Disable	Not Specified	No

Conditions to Enable Settings: Viewers Connected

Route Name: Up to 64 characters

Specify Active Time: Not Specified

Reverse Route: Disable

Edit route 1 Tour Route No. of Registrations: 3 / 64

Number	Preset Name	Speed (PT, Z)	Pause Duration
1	preset 1	20,8	10
2	preset 2	20,8	10
3	preset 3	20,8	10

Speed (PT): 20(Fast)

Speed (Z): 8(Fast)

Pause (sec) 0-3600: 10

(1) (2) (3) (4) (5)

Route List

Route Name	Conditions to Enable Settings	Active Time hh:mm-hh:mm	Revert
route 1	Viewers Connected	Not Specified	No
route 2	Disable	Not Specified	No
route 3	Disable	Not Specified	No
route 4	Disable	Not Specified	No
route 5	Disable	Not Specified	No

Conditions to Enable Settings: Viewers Connected

Route Name: Up to 64 characters

Specify Active Time: Not Specified

Reverse Route: Disable

Edit route 1 Tour Route No. of Registrations: 3 / 20

Number	Preset Name	Speed (Z)	Pause Duration
Home	home	8	10
1	preset 1	8	10
2	preset 2	8	10
3	preset 3	8	10

Speed (Z): 8(Fast)

Pause (sec) 0-3600: 10

(1) (2) (3) (4) (5)

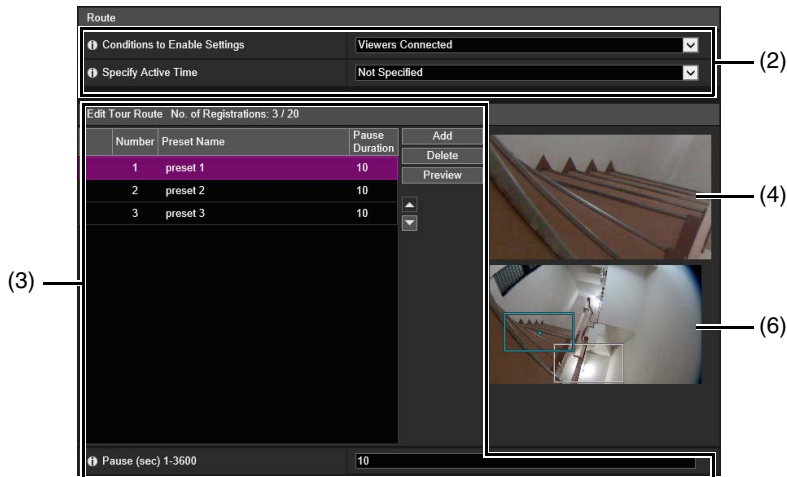

- (1) [Route List] **R1x M50 H76x**
The list of preset tour routes. Displays the tour conditions that are set. Up to five tour routes can be set.
- (2) **Tour Condition Settings**
Set the conditions for touring and the tour route name (P. 138).
- (3) [Edit Tour Route]
Displays a list of the presets to tour. The presets are toured from the top of the list.
You can change the order of the presets and set the time to stop at the preset positions, etc.
- (4) **Video Display Area**
Displays the current camera video.
- (5) **Panorama Screen** **R1x M50 H76x**
Displays the panorama images registered in the camera.

R1x M50



H76x

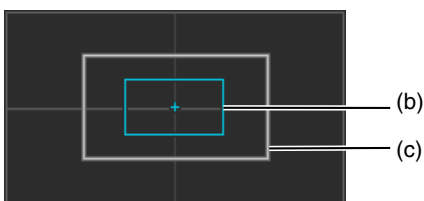

- (a) **Pan/Tilt Preview Frame (Red Frame)** **R1x M50**
Displays the vertical and horizontal range the camera can move. Displayed when the restricted view is set (P. 127).
- (b) **Preview Frame (Blue Frame)**
Indicates the current trim position in the video display area.
- (c) **Preset Preview Frame (White Frame)**
Indicates the preset/home position that is currently selected.
- (6) **Digital PTZ Panel** **H65x M64x H751 M74x**
Displays the full video obtained by the camera when starting [Preset Tour].



- (b) **Preview Frame (Blue Frame)**
Indicates the current camera angle in the video display area
- (c) **Preset Preview Frame (White Frame)**
Indicates the preset/home position that is currently selected.

Tour Route Settings

The number of tour routes you can register and the number of presets that can be toured per route are as follows.

- Maximum 5 routes, maximum 64 presets per route **R1x** **M50**
- Maximum 5 routes, maximum 20 presets per route **H76x**
- Maximum 1 route, maximum 20 presets per route **H65x** **M64x** **H751** **M74x**

Note **R1x** **M50** **H76x**

If the effective conditions or active times of the registered tour routes conflict, the routes listed higher in the [Route List] take precedence.

- 1** Select the tour route to configure from [Route List]. **R1x** **M50** **H76x**
- 2** Specify the settings for tour route name and usage.

Conditions to Enable Settings	Viewers Connected
Route Name Up to 64 characters	
Specify Active Time	Specified
Start Time hh:mm	00:00
End Time hh:mm	00:00
Reverse Route	Disable

[Conditions to Enable Settings]

Select the conditions to preform a preset tour.

[Disable]

Preset tour is not performed.

[Viewers Connected]

Preset tour is performed when a Viewer is connected to the camera.

[Always]

Preset tour is always performed.

Note

When [Disable] is selected, the following preset tour route settings cannot be configured.

[Route Name] **R1x** **M50** **H76x**

Enter the tour route name.

[Specify Active Time]

Select [Specified] to configure a preset tour at a predetermined time, and enter the start time and end time for the preset tour.

If [Viewers Connected] is set for [Conditions to Enable Settings], the preset tour operates when the Viewer is connected to the camera at the tour start time. If [Always] is set for [Conditions to Enable Settings], the preset tour always operates.

[Reverse Route] **R1x** **M50** **H76x**

If you select [Enable], the preset tour order in [Edit Tour Route] will be reversed.

- 3 Click [Add] in [Edit Tour Route].
- 4 Select a preset to tour from the [Preset List].

You can select multiple presets.





Note **R1x** **M50** **H76x**

If the position for the preset is outside the view restriction range,  (warning icon) will be displayed on the left.

- 5 Click [Add].

The preset is added to the [Edit Tour Route].

Select a preset in [Edit Tour Route] and click the [] or [] to change its position in the list.

If you select a preset in [Edit Tour Route] and then click [Delete], the preset will be deleted.

Select a preset name in the [Preset List] or [Edit Tour Route] list, and click [Preview]. The preset settings can be checked in the video display area.

Note

If a preset has already been added to [Edit Tour Route] when another preset is added from [Preset List], the added preset will be displayed below the preset selected in [Edit Tour Route].

- 6 Configure the preset speed and pause duration.

Select the preset to configure in [Edit Tour Route] and set the tour operation.

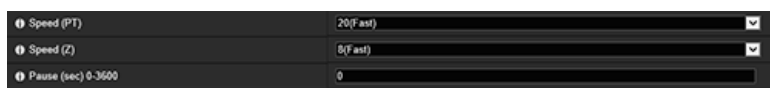

[Speed (PT)] **R1x** **M50**

Select the camera pan/tilt speed for moving to the next preset.

[Speed (Z)] **R1x** **M50** **H76x**

Select the camera zoom speed for moving to the next preset.

[Pause (sec)]

Enter the time the camera pauses at the preset position.

 **Note** **R1x** **M50** **H76x**

If you want to view video during moves between presets, select a slow speed. If you only want to switch quickly to view video at the preset positions, select a fast speed.

7 Click [Apply].

Click [Apply] after configuring the route. The setting will be saved to the camera.

 **Note**

Click [Clear] to set the route again. The settings saved in the camera are restored. However, note that presets only added to the [Edit Tour Route] by clicking [Add] are all discarded.

[Video and Audio] > [ADSR] Reducing Data Size by Lowering Video Quality in Specific Areas

Reduces the size of transmitted H.264 video by reducing the video quality of non-target areas, such as ceilings and the sky. ADSR is an abbreviation for Area-specific Data Size Reduction.

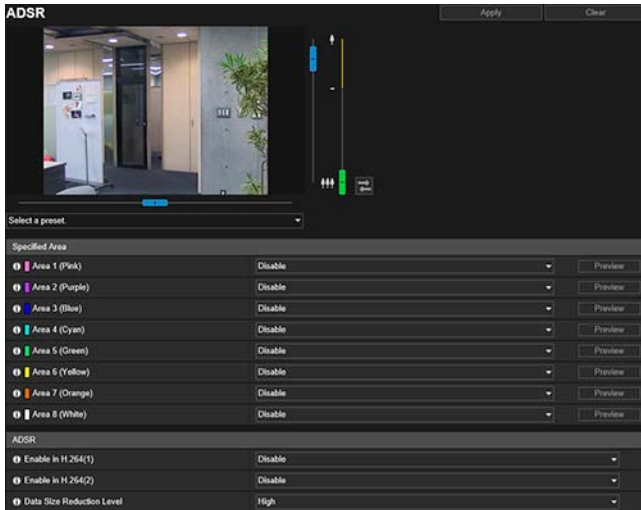

The following settings can be configured here.

- Specified Area
- ADSR

Important

Some image scenes and settings for selected areas may not be able to reduce data size using ADSR. Please test the ADSR feature in the environment before use.

Note

- The image quality of the specified area depends on the [Bit Rate Control] setting in [Video] > [H.264(1)] or [H.264(2)].
 - When [Use bit rate control] is set: The image quality is adjusted according to the situation to match the target bit rate.
 - When [Do not use bit rate control] is set: The setting in [Video] > [H.264(1)] or [H.264(2)] is retained.
- The image quality for areas outside the specified area will be reduced according to [Data Size Reduction Level].

R1x **M50** **H76x**

- Even if the camera pans, tilts, or zooms (**H76x** **H751** zoom only), the specified area follows the movement of the camera.
- Specified areas can only be configured within view restrictions.

Specified Area

Specify the area where video quality is not to be lowered.
You can specify up to eight areas with different colored frames.

Important

- If you change the [Video Flip] setting in [Camera] > [Installation Conditions], review the specified area settings.
- Reconfigure the specified area if you change the [Video] > [All Videos] > [Video Size Set] settings.

R1x **M50** **H76x**

- Configure the specified area to a slightly larger size.
- Specified areas may deviate slightly from the specified position depending on the zoom position.
- The selected area can only be set within the optical zoom range, and cannot be set using the digital zoom range (P. 67).

1 Select [Enable] for the area with the frame color to use for the specified area.

The frame for the specified area is displayed on the video display area.

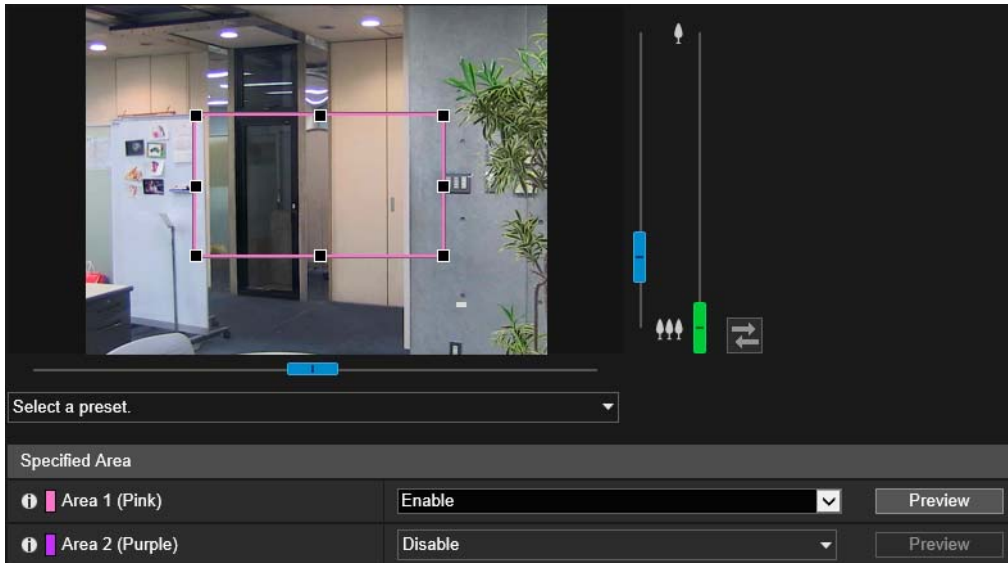

2 Set the specified area.

Set the specified area as follows within the display area.

- Drag out a frame and move it to the area you want to specify.
- Change the size of the frame by dragging any of the eight handles (■).
- To change the camera angle, perform either of below **R1x** **M50** **H76x**
Control using the pan/tilt/zoom sliders (**H76x** zoom only)
Select a preset in the preset selection box

3 Click [Apply].

The settings are saved to the camera.

Note

You can use the Camera Viewer to check video with ADSR settings applied. Video outside the specified area will deteriorate according to the amount of applied data reduction.

[Preview] **R1x** **M50**

The camera will move to a specified area if you click [Preview] for that area.

Note **R1x** **M50** **H76x**

If you change the camera angle before operating the area frame, the area frame may become hidden. To display the area frame again, either click the [Preview] for the target specified area, or use the slider to move the camera angle to a position in which the entire area frame is displayed.

ADSR

Set the data size reduction of outside areas set with [Specified Area].

[Enable in H.264(1)]

Select [Enable] to lower video quality of outside areas set with [Specified Area] in H.264(1) video.

[Enable in H.264(2)]

Select [Enable] to lower video quality of outside areas set with [Specified Area] in H.264(2) video.

[Data Size Reduction Level]

Set the data size reduction level for the outside area of [Specified Area]. If you select [Low], the data size reduction effect is lower. If you select [High], the data size reduction effect is higher.

[Video and Audio] > [On-screen display] Displaying Date, Time and Text on the Video

Displays the date and time, camera name and other text on the Video.

On-screen display		Apply	Clear
On-screen display			
Date display	Enable		
Position of date display	Upper left		
Format of date display	YYYY/MM/DD		
Time display	Enable		
Position of time display	Upper left		
Text display	Display designated string		
Position of text display	Upper left		
Text string display <small>Up to 40 characters</small>			
Color of text	White		
Background color	Black		
Color depth of text and background	Fill text and background color		

The following settings can be configured here.

- On-screen display

Important

The on-screen time display is not suitable for usage where high reliability is required. Only use it as reference information on systems where utmost and constant reliability is required for surveillance.

Note

- Depending on video quality settings, the on-screen display may become difficult to decipher. Set it after confirming appearance on actual video
- When using digital PTZ, on-screen display will not be displayed if the cropped video has a horizontal size of 384 pixels or less.
M50 H65x M64x H76x H751 M74x
- Setting the [Text display], [Date display], and [Time display] to the same position may result in not displaying all of the information. In such case, items set with [Upper right] or [Lower right] for [Position of text display] are prioritized for display.
- All of the texts may not be displayed depending on the video size, text length, and text position. Check the display after changing the video size and on-screen display settings.

On-Screen Display

[Date display]

Select whether to display the date on the Video.

[Position of date display]

Select position for date display on the Video.

[Format of date display]

Select the year, month and day display order.

[Time display]

Select whether to display the time on the Video.

[Position of time display]

Select position for time display on the Video.

[Text display]

Select the text strings to display on the Video.

[Display designated string]

Displays the text string entered in [Text string display] below.

[Display camera name]

Displays the camera name entered in [Camera Name] (P. 107).

[Position of text display]

Select position for text display on the Video.

[Text string display]

If [Text display] is set to [Display designated string], enter the text string to be displayed in alphanumeric characters.

[Color of text]

Select from eight colors for the text color.

[Background color]

Select from eight colors for the background color.

[Color depth of text and background]

Select a color depth combination (Filling, Transparence, Translucence) for the text and background color.

[Video and Audio] > [Privacy Mask] Setting Privacy Mask

Mask any areas of the camera video. You can check the camera video and set up to eight privacy masks. When the camera is panned, tilted, or zoomed, the privacy mask areas follow the camera video.

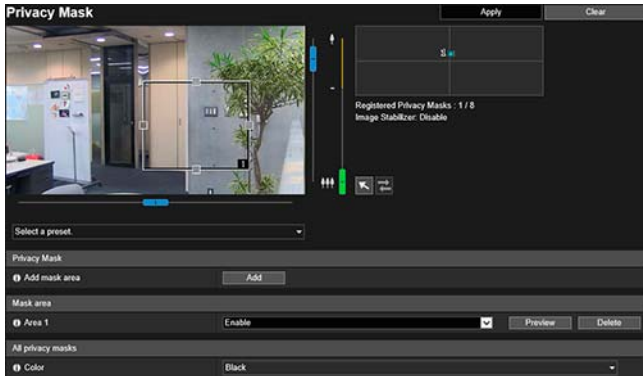

The following settings can be configured here.

- Privacy Mask
- Mask area
- All privacy masks

Important

- Privacy masks are applied to all video transmitted from the camera (live video, uploaded video, recorded video and video recorded to a memory card).
- Privacy masks are not available in the following situations.
 - When the camera is launched immediately after being turned on.
 - For camera video in the camera angle settings **H651** **M64x**
 - While a panorama image is being created. **R1x** **M50**
- Intelligent Function detection also works in the privacy mask areas. The [Intelligence Function] Setting Page displays the profile line of detected objects, etc., so you may be able to tell the movement of subjects even if a mask is applied.

Registering Privacy Masks

Use the mouse to position and size the privacy mask areas, then save the settings to the camera.

- 1 Display the area which you want to add as a mask area on the video display area. **R1x** **M50** **H76x**

Use the sliders to operate the camera angle.

R1x **M50**

You can perform the following operations while the  mouse operation switch button is purple after clicking it.

- Centering the camera angle to the position you click in the video display area
- Area zoom operations (P. 67)

R1x **M50** **H76x**

Change the camera angle by selecting a preset in the preset selection box

Note **R1x** **M50**

The preview frame is not shown on the video display area while the mouse operation switch button is purple.

R1x M50

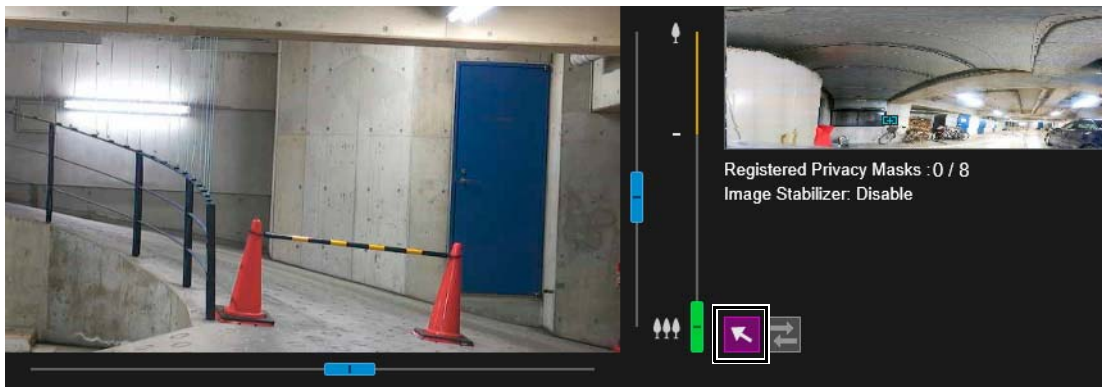

2 In [Add mask area], click [Add].

The preview frame attached with the area number is displayed on the video display area. The privacy mask area for the corresponding number is also displayed on the privacy mask registration area.

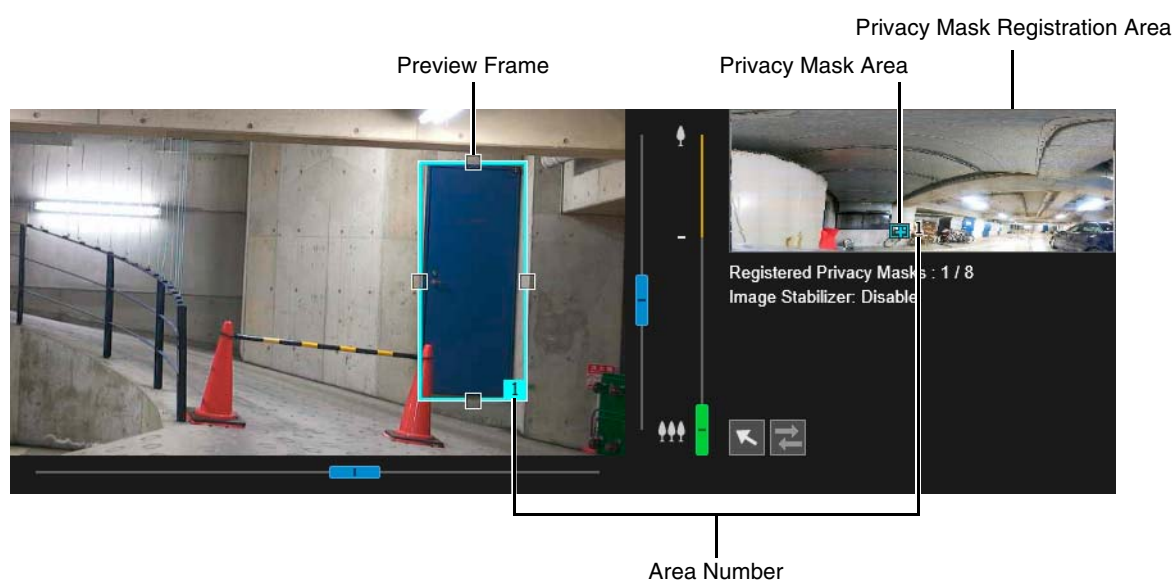

3 Set the size and position for the preview frame in the video display area.

Drag the preview frame displayed in the video display area to the position you want to mask. Change the size of the preview frame by dragging the handles (□) positioned on its four sides.



Important R1x M50 H76x

Set the privacy mask area to a slightly larger size than the area you want to hide.

4 Set [Mask area] to [Enable].

The settings for the privacy mask area is enabled.

Set [Mask area] to [Disable] to temporarily disable a privacy mask area without deleting it. The disabled privacy mask area of the registration area will be displayed with a crossed out frame.

5 Change the color for the privacy mask area with [Color] as necessary.

The color selected here is reflected to all the preview frames and privacy mask areas.

6 To add privacy mask areas, repeat steps 1 to 5.

You can save up to eight privacy masks.

7 Click [Apply].

The privacy mask area is saved to the camera.

Saved privacy mask areas are shown in the video display area and the privacy mask registration area.

Important

- Check privacy mask settings again if you change the [Basic] > [Video] > [All Videos] > [Video Size Set] settings.
- You will need to set the position of the privacy mask again if you change the [Video Flip] setting in [Camera] > [Camera] > [Installation Conditions].
- If you reconfigure privacy mask settings after you changed the [Camera] > [Camera] > [Camera Control] > [Image Stabilizer], reconfigure all privacy mask positions and sizes.
- If you change the privacy mask settings after saving a panorama image using the panorama function, you must use the panorama function to recreate the panorama image (P. 123). **R1x M50**

R1x M50 H76x

- After registering a privacy mask, pan, tilt and zoom the camera to confirm the areas you want to mask do not become visible when the camera angle is altered.
- Privacy masks may deviate slightly from the specified position depending on the zoom position.

Changing/Deleting a Privacy Mask

■ Privacy Mask Registration Area

This shows the positions of privacy mask areas in the entire area that can be captured by the camera.

R1x M50



H65x M64x H76x H751 M74x



(1) Entire Area That Camera Can Capture

This shows the area that can physically be captured.

R1x M50

If a panorama image is registered in the camera, the panorama image is displayed here.

(2) View Restriction Area **R1x M50**

Appears in gray if view restrictions have been configured (P. 127).

(3) Privacy Mask Areas

Privacy mask areas with [Mask area] set to [Enable] (P. 146) are filled in.

Privacy mask areas with [Mask area] set to [Disable] (P. 146) have diagonal lines displayed in them.

(4) Preview Frame **R1x M50**

Indicates the current position of the camera displayed in the video display area.

■ Changing Mask Position and Size

How to Select a Privacy Mask

The following methods are available for selecting the privacy mask area.

- Click the privacy mask area you want to change in the privacy mask registration area.
- Click [Preview] in the mask area you want to display.
- Click the privacy mask area displayed in the video display area.

1 Select the privacy mask area you want to change.

2 Change the position and size of the privacy mask area.

Move the preview frame by dragging it and change its size by dragging the handles (□) positioned on its four sides.



Note

To discard changes and restore settings saved to the camera, click [Clear]. However, note that mask area settings that have not been saved in the camera by clicking [Apply] are all discarded.

3 Click [Apply].

The changed privacy mask area is saved to the camera.

■ Deleting a Privacy Mask from the Camera

Click [Delete] for [Mask area] in the privacy mask that you want to delete, then click [Apply].
The selected privacy mask area is deleted from the camera.

[Video and Audio] > [Audio] Setting Audio Input/Output

R13 R11 M50 H65x M641 H761 H751 M741

Settings for audio input from the microphone connected to the camera and audio output from the Viewer. The output sound clip used when an event is triggered can also be registered.

Audio		Apply	Clear
General Audio			
Input Volume 1 - 100	50		
Output Volume 1 - 100	50		
Echo Canceller	Disable		
Audio Input	Line In		
Sound Clip Upload 1			
Browse File		Browse...	Add
Sound Clip Name Up to 15 characters			Delete
Sound Clip Upload 2			
Browse File		Browse...	Add
Sound Clip Name Up to 15 characters			Delete
Sound Clip Upload 3			
Browse File		Browse...	Add
Sound Clip Name Up to 15 characters			Delete

The following settings can be configured here.

- General Audio
- Sound Clip Upload 1 to 3

5

Setting Page

Important

- Video and audio can be distributed to up to 30 clients. However, when there are many clients or they are connected to the camera over an SSL/TLS connection, the video frame rate may slow down and the sound may drop out if audio reception from the camera is enabled.
- The video and audio may not be synchronized.
- If the [Input Volume] or [Echo Canceller] setting is changed after setting volume detection (P. 166) or scream detection (P. 167), check the detection setting again.
- The audio may be temporarily interrupted, depending on the performance of the computer and the network environment.
- The audio may be interrupted if anti-virus software is enabled.
- Communication may be temporarily interrupted, cutting off the audio, if the LAN cable is unplugged and plugged in again. If this occurs, reconnect from the Viewer.
- The volume, sound quality, etc., may change depending on the characteristics of the microphone used.
- Use a speaker with an amplifier to connect to the camera (please refer to "Installation Guide").

General Audio

Set the audio input/output volume, echo cancellation and microphone type.

[Input Volume]

Enter the input volume from the microphone connected to the camera.

This is applied when [Server] > [Audio Server] > [Audio Transmission from the Camera] (P. 155) is set to [Enable].

[Output Volume]

Enter the output volume from the Viewer to the speaker connected to the camera.

This is applied when [Server] > [Audio Server] > [Audio Reception from Viewer] (P. 155) is set to [Enable].

[Echo Canceller]

Select to enable or disable the Echo Canceller for suppressing echoes that occur between the microphone and speaker.

This is applied when [Server] > [Audio Server] (P. 155) is set to the following.

- [Audio Transmission from the Camera] is set to [Enable]
- [Audio Reception from Viewer] is set to [Enable]

Important

Use of the Echo Canceller may affect audio quality and volume. Use it when necessary to suit the installation environment and camera usage.

[Audio Input]

Select the type of microphone connected to the camera.

Caution

If using a microphone, switch [Line In] and [Microphone In] with [Audio Input] to suit the specifications of the microphone.
Using the wrong input may damage the camera and/or microphone. Be sure to configure settings correctly.

Sound Clip Upload 1 to 3

You can upload up to three sound clips for playback when an event is triggered.



Note

The sound clip is used when audio playback is set in [Event] > [External Device Input] (P. 164) or [Event] > [Intelligent Function] > the [Event] tab (P. 199).

[Browse File]

Specify the sound clip to upload and click [Add].

To be able to upload a sound clip, it must satisfy the following requirements.

- Playback length: Less than 20 seconds
- File Format: ".wav" (μ-law PCM 8bit. Sampling frequency 8000 Hz, monaural)

A sample sound clip is included on the Setup CD-ROM in the SOUND folder.

If it is blank when you click [Apply], the sound clip registered in the camera will be deleted.

To delete an uploaded sound clip, click [Delete] next to the name of the sound clip.

[Sound Clip Name]

Enter the name of the sound clip to upload.

Be sure to enter the sound clip name.

[Server] > [Server] HTTP, SNMP and FTP Server Settings

Settings for HTTP server, SNMP server, FTP server usage or WS-Security time checks.

The screenshot shows the 'Server' settings page with the following sections:

- HTTP Server:** Authentication Method (Digest Authentication), HTTP Port (80), HTTPS Port (443).
- SNMP Server:** Use SNMP v1 and v2c (Enable), Use SNMP v3 (Enable), Administrator Contact Information, Administration Function Name (VB), Installation Location.
- SNMP v1 and v2c Server:** Community Name (community name).
- SNMP v3 Server:** User Name (user name), Security Level (Authentication and encryption), Authentication Algorithm (MD5), Authentication Password (*****), Encryption Algorithm (DES), Encryption Password (*****).

The following settings can be configured here.

- HTTP Server
- SNMP Server
- SNMP v1 and v2c Server
- SNMP v3 Server
- FTP Server
- WS-Security

The screenshot shows the 'FTP Server' and 'WS-Security' settings:

- FTP Server:** Use FTP Server (Enable), User Name (username), Password (*****).
- WS-Security:** Check Time on Authentication (Check).

HTTP Server

Set the authentication method and HTTP port number.

Important

If the setting of [HTTP Port] or [HTTPS Port] is changed and the camera may become inaccessible from the active web browser, a confirmation dialog box will be displayed. Click [OK] to apply the new setting.
If you reboot the camera and cannot connect to the camera from the web browser, any available URI for connecting to the camera will be displayed in a message.
If you cannot connect to the camera through the displayed URI, contact your system administrator.

[Authentication Method]

Select an authentication method for use by the HTTP server.

[HTTP Port]

Enter an HTTP port number.

Normally use [80] (factory default setting).

[HTTPS Port]

Enter an HTTPS port number.

Normally use [443] (factory default setting).

SNMP Server

Configure the necessary settings to use SNMP.

Note

- The camera information referenced from the SNMP manager is read-only.
- Use an SNMP Manager that supports SNMP MIB2 (supporting RFC1213).

[Use SNMP v1 and v2c]

If you select [Enable], you can use SNMP v1 and v2c to browse the camera information from an SNMP manager.

[Use SNMP v3]

If you select [Enable], you can use SNMP v3 to browse the camera information from an SNMP manager.

[Administrator Contact Information]

Enter contact information (e-mail address, etc.) for the administrator of the camera. Setting information can be referenced by the SNMP manager.

[Administration Function Name]

Enter the camera name used for administration. Setting information can be referenced by the SNMP manager. If left blank, the camera model name will be used.

[Installation Location]

Enter information regarding the installation location of this camera. Setting information can be referenced by the SNMP manager.

SNMP v1 and v2c Server

[Community Name]

If you select [Enable] for [Use SNMP v1 and v2c], enter the community name to use for SNMPv1 and v2c. The factory default setting is blank.

SNMP v3 Server

[User Name]

If you selected [Enable] for [Use SNMP v3], set the user name to use with SNMP v3.

[Security Level]

Select the security level to use for SNMP v3.

[Authentication Algorithm]

If you selected [Authentication but no encryption] or [Authentication and encryption] for [Security Level], select the authentication algorithm.

[Authentication Password]

If you selected [Authentication but no encryption] or [Authentication and encryption] for [Security Level], set the authentication password.

[Encryption Algorithm]

If you selected [Authentication and encryption] for [Security Level], select the encryption algorithm.

[Encryption Password]

If you selected [Authentication and encryption] for [Security Level], set the encryption password.

FTP Server

[Use FTP Server]

The settings for using an FTP server.

[User Name]

Set the name of the user to allow FTP connections for.

[Password]

Set the password of the user to allow FTP connections for.



Important

- Canon will assume no liability for any accident or damage resulting from use of FTP software.
- When changing the user name, make sure to also change the password.
- If you set the same user name as a user name used in the system, the message "User name is invalid." is displayed. In this case, set another user name.

WS-Security

[Check Time on Authentication]

Select whether to check the time information of data transmitted by the client.

[Server] > [Video Server] Video Transmission Settings

Settings for clients that can connect to a video server.

Video Server		Apply	Clear
Video Server			
Maximum Number of Clients 0 - 30	30		
Camera Control Queue Length 0 - 30	30		
Maximum Connection Time (sec.) 0 - 65535	0		
Camera Control Time (sec.) 1 - 3600	20		

The following settings can be configured here.

- Video Server

Video Server

[Maximum Number of Clients]

Enter the maximum number of clients that can be connected to the camera at the same time.

If set to [0], only administrators will be able to connect.



Important

R13 R11 M50 H65x M641 H761 H751 M741

When there are many clients or they are connected to the camera over an SSL/TLS connection, the video frame rate may slow down and the sound may drop out if audio reception from the camera is enabled.

[Camera Control Queue Length]

Enter the maximum queue length for clients requesting camera control privileges from the Camera Viewer.

If set to [0], only administrators can queue for camera control.

[Maximum Connection Time (sec.)]

Enter the maximum time in seconds during which an individual client can connect to the camera.

If set to [0], the connection time is unlimited.

[Camera Control Time (sec.)]

Enter the maximum time Camera Viewer can retain camera control privileges.

[Server] > [Audio Server] Audio Transmission/Reception Settings

R13 R11 M50 H65x M641 H761 H751 M741

Settings for audio transmission from the camera to the computer, and audio reception from the computer to the camera.

Audio Server		Apply	Clear
Audio Server			
Audio Transmission from the Camera	Disable		
Voice Activity Detection	Disable		
Audio Reception from Viewer	Disable		

The following settings can be configured here.

- Audio Server

5

Setting Page

Audio Server

[Audio Transmission from the Camera]

Select to transmit audio from the microphone connected to the camera to the Viewer.

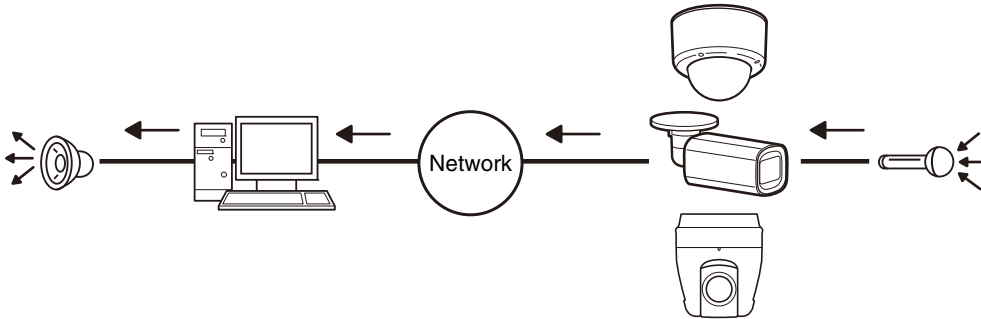

[Voice Activity Detection]

Select whether to detect when there is no sound coming from the microphone.

When set to [Enable], audio data transmission will pause while there is no sound input from the camera. This can reduce the load on the network used.

[Audio Reception from Viewer]

Select to receive audio from Camera Viewer and RM Viewer.

Received audio can be output from a speaker with an amplifier connected to the camera.

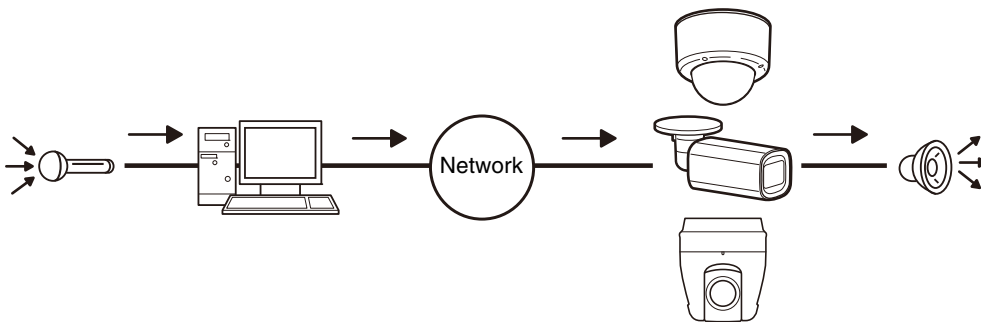

[Server] > [RTP Server] RTP Settings

Set the video and audio transmission using RTP.

RTP Server		Apply	Clear
RTP Server			
RTSP	Enable		
RTSP Authentication Method	Digest Authentication		
RTSP Port	554		
Audio Multicast			
Multicast Address	0.0.0.0		
Multicast Port	0		
Multicast TTL	1		
RTP Stream 1			
Video Size	320 x 180 JPEG		
Frame Rate	5		
Multicast Address	0.0.0.0		
Multicast Port	0		
Multicast TTL	1		
Audio Transmission	Disable		

The following settings can be configured here.

- RTP Server
- Audio Multicast
- RTP Stream 1 to 5

RTP Server

Enable RTP, and set the RTSP authentication method and port number.

[RTP]

Select this to enable or disable RTP.

[RTSP Authentication Method]

Select an authentication method for RTSP. Since the RTSP authentication method is configured independently of the HTTP authentication method, you need to configure each authentication method.

[RTSP Port]

Enter the RTSP port number.

Normally use [554] (factory default setting).

Audio Multicast

R13 R11 M50 H65x M641 H761 H751 M741

Set multicast for audio transmission.

[Multicast Address]

Enter the multicast address for audio transmission as follows.

IPv4: Range from 224.0.0.0 to 239.255.255.255.

IPv6: Address starting with ff00::/8

Set IPv4 to [0.0.0.0] and IPv6 to [::0 (::)] to disable multicast.

[Multicast Port]

Enter the multicast port number for audio transmission.

If set to [0], multicast is disabled.

[Multicast TTL]

Enter the effective range for multicast transmission.

If set to [0], multicast is disabled.

The TTL (Time To Live), representing the effective range for multicast transmission, is decremented each time the signal passes through a router. When the value reaches 0, the signal can no longer pass through the router and be transmitted. For example, if TTL is set to [1], multicast transmission is confined to the local segment only and cannot pass through the router to be transmitted.

RTP Stream 1 to 5

You can set each stream for RTP stream transmission in an RTP Stream 1 to RTP Stream 5 session.

[Video Size]

Select the video format (JPEG or H.264) and video size for the RTP stream.

The video sizes for JPEG will vary depending on the [Video Size Set] settings (P. 102).

The video sizes for H.264 will be determined according to the [H.264(1)] and [H.264(2)] settings in [Video] (P. 103).

In addition, [H.264(2)] cannot be set for multiple RTP streams.

[Frame Rate]

Enter the frame rate if the RTP stream is JPEG video.

This cannot be set for H.264 video. The [Frame Rate] setting in [Video] > [H.264(1)] or [H.264(2)] will be used.

[Multicast Address]

Enter the multicast address for RTP streaming as follows.

IPv4: Range from 224.0.0.0 to 239.255.255.255.

IPv6: Address starting with ff00::/8

Enter [0.0.0.0] for IPv4 and [::0(::)] for IPv6 to disable multicast.

[Multicast Port]

Enter the multicast port number for RTP streaming.

If set to [0], multicast is disabled.

[Multicast TTL]

Enter the effective range for multicast transmission of RTP streams.

If set to [0], multicast is disabled.

The TTL (Time To Live), representing the effective range for multicast transmission, is decremented each time the signal passes through a router. When the value reaches 0, the signal can no longer pass through the router and be transmitted. For example, if TTL is set to [1], multicast transmission is confined to the local segment only and cannot pass through the router to be transmitted.

[Audio Transmission] **R13** **R11** **M50** **H65x** **M641** **H761** **H751** **M741**

Select whether to use audio transmission for RTP streaming.

Note

- RTP Streaming URL
rtsp://IP Address:Port Number/rtpstream/config1(to 5)=rlulm
[=rlulm] is optional and can be omitted. If specified, specify only one option.
r: Requests RTP over TCP
u: Requests RTP over UDP
m: Requests multicast
Example: RTP Streaming 1 request using RTP over TCP
rtsp://192.168.100.1:554/rtpstream/config1=r
Caution: Note that the actual operation is dependent on the RTP client application, so the URL does not necessarily specify the method used for transmission.
- When H.264 is selected, bit rate control and video quality are each set with [Video] (P. 103).
- The [Video Distribution] and [Audio Distribution] settings in [Basic] > [User Management] > [User Authority] are not used for RTP.
- RTP streaming video may not be viewable on systems using a proxy server or firewall. If this occurs, contact your system administrator.
- If Host Access Restrictions are applied to a client while it is streaming using RTP over UDP, it may take from a few to tens of seconds until streaming ceases.
- Regardless of the [Server] > [Audio Server] > [Audio Transmission from the Camera] setting, RTP streaming audio will be used.

R13 **R11** **M50** **H65x** **M641** **H761** **H751** **M741**

[Video Record] > [Upload] HTTP and FTP Upload Settings

Settings for uploading video via HTTP or FTP when an event is triggered.

Use [Server] > [Server] (P. 151) to configure HTTP server and FTP server settings for uploading.

Upload		Apply	Clear
Video Record Settings			
Video Record Action	Upload		
General Upload			
Upload	HTTP Upload		
Video Format	JPEG		
Frame Rate 1 - 10	1		
Pre-event Buffer (number of frames) 0 - 100	0		
Post-event Buffer (number of frames) 0 - 100	0		
HTTP Upload			
Notification	Video attached Notification with HTTP		
URI Up to 255 characters	563154568755769		
User Name Up to 31 characters			
Password Up to 31 characters	*****		
Proxy Server Up to 63 characters			
Proxy Port 1 - 65535	80		
Proxy User Name Up to 31 characters			
Proxy Password Up to 31 characters	*****		
Parameter (query string) Up to 127 characters			
HTTP Upload Test	Exec		

The following settings can be configured here.

- Video Record Setting
- General Upload
- HTTP Upload
- FTP Upload

FTP Upload	
Notification	Video data upload with FTP
FTP Server Up to 63 characters	2357745457531574852
User Name Up to 31 characters	administrator
Password Up to 63 characters	*****
PASV Mode	Enable
File Upload Path Up to 255 characters	
File Naming	YYYYMMDDHHMMSSms
FTP Upload Test	Exec



Important

- When using the upload function or recording to a memory card, the following settings are required according to each event.
 - [Video Record] settings configured with [Event] > [Timer].
 - [Video Record] settings configured with each of the [Event] > [External Device], [Audio Detection] and [Linked Events].
 - The setting in the [Event] tab of the Intelligent Function (P. 199).
- When using the upload function, or recording to the memory card, do not change the settings in the [Settings Page]. Doing so may result in the upload function or the recording to memory card to stop.
- If you are using either HTTP or FTP upload together with e-mail notification by text and video, set [Video] > [JPEG] > [Video Size: Upload / Memory card] (P. 103) to a small size.
- HTTP upload does not support SSL/TLS.
- If the camera is set to upload or send e-mail notification continuously, not all video or e-mails may be sent depending on the video size and the network condition to the server. If this occurs, a message is written to the log (P. 224).
- If the destination for HTTP or FTP upload, or e-mail notification is set for a Windows operating system, IPsec communication is not supported.

Video Record Setting

When an event is triggered, you can set whether to upload camera video with HTTP or FTP or to record the video to a memory card.

This item can also be set with the [Memory Card] submenu (P. 217) and will be reflected in [Video Record Settings] here.

[Video Record Action]

Select [Upload] to upload video.

General Upload

Set the upload method and video format for upload.

[Upload]

Select whether to upload with HTTP or FTP.

[Video Format]

Select the video format for upload.

Video size and quality of the uploaded video follow the settings in [Video] (P. 102).



Important

- For H.264(1) or H.264(2), the following settings must be configured in [Video] > [H.264(1)] (P. 103) or [H.264(2)] (P. 104).
 - [Bit Rate Control]: [Use bit rate control]
 - [Target Bit Rate (kbps)]: [3072] or less
 - [I Frame Interval (sec)]: [0.5], [1] or [1.5]
- You cannot select a different H.264 format from that in [Memory Card] > [Memory Card Operations] > [Video Format] (P. 218).

[Frame Rate]

Enter the maximum frame rate of video to be uploaded when [Video Format] is set to [JPEG].

[Pre-event Buffer (number of frames)] (JPEG)/ [Pre-event Buffer (sec)] (H.264)

Enter the number of frames or seconds of video to be buffered before the event.

Enter the maximum number of frames for [JPEG] or the maximum number of seconds for [H.264(1)] or [H.264(2)] in [Video Format].

[Post-event Buffer (number of frames)] (JPEG)/ [Post-event Buffer (sec)] (H.264)

Enter the number of frames or seconds of video to be buffered after the event.

Enter the maximum number of frames for [JPEG] or the maximum number of seconds for [H.264(1)] or [H.264(2)] in [Video Format].



Important

The maximum video buffer size capacity is approx. 56 MB. If a large video size is set, the Frame Rate, Pre-event Buffer and Post-event Buffer may not be achieved as specified.

If buffering cannot be achieved as specified, a message is written to the log (P. 224). Confirm that no messages are displayed in the log.

Note

If the server or network load increases due to the upload settings, the video frame rate may drop. If this occurs, reconfigure the following settings to reduce the size and frequency of uploaded data.

- Set a lower value for [Video Size: Upload / Memory card] for [JPEG] (P. 103).
- Reduce the number of frames or seconds in [Pre-event Buffer] or [Post-event Buffer].
- If [Volume Detection Event] is enabled, disable [ON Event Operation], [OFF Event Operation] or [Ongoing ON Event Operation] (P. 166).
R13 R11 M50 H65x M641 H761 H751 M741
- From the Intelligent Function [Event] tab, disable [ON Event Operation], [OFF Event Operation] or [Detected mode Operation] (P. 199).
- If [External Device Input Event] is enabled, disable [Active Event Operation], [Inactive Event Operation] or [Ongoing Active Event Operation] (P. 164). R13 R11 M50 H65x M641 H761 H751 M741
- If [Timer Event] is enabled, increase the value in [Repeat Interval] (P. 169).

HTTP Upload

Settings for the HTTP upload function when [Upload] is set to [HTTP Upload].

The HTTP upload function sends notifications via HTTP or via HTTP with attached images, depending on the network camera event.

For information about the HTTP upload function and settings, contact your nearest Canon Customer Service Center.

[Notification]

Select whether to send event information notifications only or notifications with attached videos when using HTTP upload.

[URI]

Enter the HTTP server URI to which to upload.

[User Name], [Password]

Enter the user name and password required for authentication.

Digest authentication is not supported.

[Proxy Server]

If using a proxy server, enter the host name or IP address of the proxy server.

[Proxy Port]

If using a proxy server, enter the port number of the proxy server.

[Proxy User Name], [Proxy Password]

Enter to use a user name and password for the proxy server.

Digest authentication is not supported.

[Parameter (query string)]

Enter the request parameters.

Parameters can be specified using the “%” character (P. 228).

[HTTP Upload Test]

Clicking [Exec] initiates an upload test based on the settings currently entered.

Only a single JPEG image will be uploaded, but it is not necessary to click [Apply] at that time. After entering a password, first click [Exec], then click [Apply].



Important

Enter [Proxy Server], [Proxy Port], [Proxy User Name] and [Proxy Password] if connecting via a proxy server.

FTP Upload

Settings for the FTP upload function when [Upload] is set to [FTP Upload].

[Notification]

This is set to [Video data upload with FTP].

[FTP Server]

Enter the host name or IP address of FTP server.

[User Name], [Password]

Enter the user name and password required for authentication.

[PASV Mode]

Select whether to use PASV mode when connecting to an FTP server.

[File Upload Path]

Enter a remote path (directory name) for video files to be uploaded to.

[File Naming]

Select a file naming rule for the upload file.

[YYYYMMDDHHMMSSms]

Video is uploaded according to the file name format of “{year}{month}{day}{hour}{minute}{second}{ms}.jpg”.

(Example: 20160123112122000.jpg)

[YYYYMMDD Directory/HHMMSSms]

A subdirectory named “{year}{month}{day}” is created first, and then the video is uploaded using the file name

“{hour}{minute}{second}{ms}.jpg”.

(Example: 20160123/112122000.jpg)

[Loop]

Video is loaded with a file name numbered in sequence from 0000 up to the value set in [Maximum Number of Loops].

(Example: 0000.jpg, 0001.jpg) The number will return to 0000 when the maximum number of loops is reached.

Since the way FTP servers manage the upload of files with existing file names differs as follows, be sure to check the FTP server specifications before configuring this setting.

- Overwrite the existing file name
- Automatically save the file with a different name
- Generate an error

[Maximum Number of Loops]

If [Loop] is set under [File Naming], enter the maximum number of loops.

[User Settings]

Video is uploaded according to the file naming method specified in [Subdirectory Name to Create] and [File Name to Create].

[Subdirectory Name to Create], [File Name to Create]

If [File Naming] is set to [User Settings], enter the subdirectory name to be created as well as the name of the created file.

Parameters can be specified in the entry with the “%” character (P. 228).

[FTP Upload Test]

Clicking [Exec] initiates an upload test based on the settings currently entered.

Only a single JPEG will be uploaded, but it is not necessary to click [Apply] at that time. After entering a password, first click [Exec], then click [Apply].

[Video Record] > [E-mail Notification] Setting E-mail Notification

Settings for sending an e-mail notification to a specified recipient when an event is triggered.

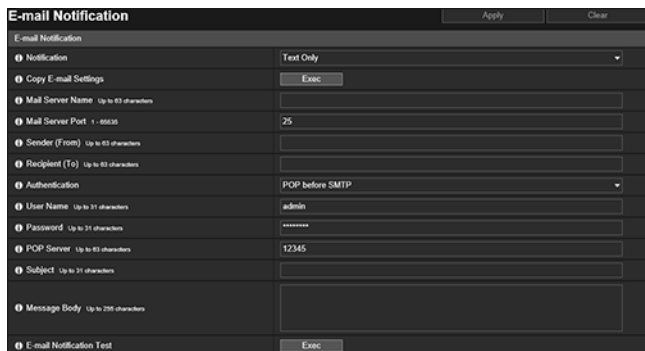

The following settings can be configured here.

- E-mail Notification

E-mail Notification

Set the mail server to be used for e-mail notifications and the content of the e-mail to be sent.

[Notification]

[Subject] and [Message Body] are text.

If you set [Text with Video], an image (JPEG format) captured immediately before the event will be attached.

[Copy E-mail Settings]

Copy the e-mail settings used in [Maintenance] > [Log] > [Log Notifications] (P. 224). However, the password is not copied.

[Mail Server Name]

Enter the host name or IP address of the SMTP server.

[Mail Server Port]

Enter the port number for the SMTP server.

[Sender (From)]

Enter the e-mail address of the sender.

[Recipient (To)]

Enter the e-mail address of the recipient.

[Authentication]

Select an authentication method suited to the destination SMTP server.

[User Name], [Password], [POP Server]

Enter the user name and password needed for authentication, and the POP server host name or IP address when e-mail authentication is set to [POP before SMTP].

[User Name], [Password]

Enter the user name and password needed for authentication when e-mail authentication is set to [SMTP-AUTH].

[Subject]

Enter the subject of the e-mail in alphanumeric characters.

[Message Body]

Enter the message body (text) of the e-mail in alphanumeric characters.
Parameters can be specified in the text using the “%” character (P. 228).

[E-mail Notification Test]

Clicking [Exec] initiates an e-mail notification test based on the settings currently entered.

It is not necessary to click [Apply]. After entering a password, first click [Exec], then click [Apply].

[Event] > [External Device] External Device Input Triggered Operation Settings

R13 R11 M50 H65x M641 H761 H751 M741

Operation settings for external device output and for external device input triggered events.

External Device		Apply	Clear
External Device Output 1			
Operation Mode	Normally Open		
Active Output Format	Continuous		
Pulse Output Time (sec) 1 - 120	1		
External Device Output 2			
Operation Mode	Normally Open		
Active Output Format	Continuous		
Pulse Output Time (sec) 1 - 120	1		
External Device Input			
External Device Input Event	Enable		

The following settings can be configured here.

- External Device Output 1, 2
- External Device Input
- External Device Input 1, 2

External Device Input 1	
Operation Mode	Normally Open
Active Event Operation	Enable
Inactive Event Operation	Disable
Ongoing Active Event Operation	Disable
Preset	None
Video Record	Disable
E-mail Notification	Disable
External Device Output for Active Event	Disable
External Device Output for Inactive Event	Disable
Audio Playback at Active Event	Enable
Audio Playback at Inactive Event	Disable
Sound Clip	SAMPLE
Volume 1 - 100	50
Day/Night Mode Switching	Disable

External Device Output 1, 2

Set the operation for output to the external device.

The camera has two external device outputs. You can set the output for each of them.

Note

The output for an external device can be switched between active and inactive with [External Device Output] of the Camera Viewer (P. 82).

[Operation Mode]

Select whether the output terminals are normally open or closed.

If you set [Normally Open], an active event occurs when the output terminal connection closes, and an inactive event occurs when the output terminal connection opens.

If you set [Normally Close], an active event occurs when the output terminal connection opens, and an inactive event occurs when the output terminal connection closes.

Normally Open

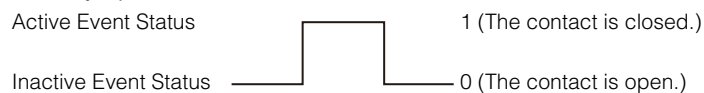

Normally Close

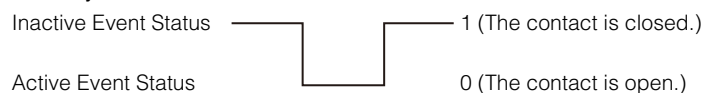

[Active Output Format]

Select the output format when the external device output is active.

[Pulse Output Time (sec)]

Enter the output duration time (sec.) when [Active Output Format] is set to [Pulse].

Important

When [Active Output Format] is set to [Pulse] and a timer is used (P. 169), contact output is controlled only once when the timer starts.

External Device Input

[External Device Input Event]

Select whether to use the input from an external device, such as a connected sensor, as an event.

External Device Input 1, 2

You can set the operation to be performed when an event is triggered by input from an external device.

The camera has two external device inputs. You can set the input for each of them.

You can set these if you have selected [Enable] in [External Device Input Event].

Note

An icon in the [Event and Input/Output] menu of the Camera Viewer will indicate when there is an external device input event (P. 82).

[Operation Mode]

Select the circuit condition to suit the signal input from the connected external device.

When [Normally Open] is set, an active event occurs when the terminals of the external device close, and an inactive event occurs when the terminals open.

When [Normally Close] is set, an active event occurs when the terminals of the external device open, and an inactive event occurs when the terminals close.

[Active Event Operation]

Select the operation to be performed when an active event is triggered.

If [Enable] is set, [Preset], [Video Record] and [E-mail Notification] will be executed according to their settings when an active event is triggered.

[Inactive Event Operation]

Select the operation to be performed when an inactive event is triggered.

If [Enable] is set, [Preset], [Video Record] and [E-mail Notification] will be executed according to their settings when an inactive event is completed.

[Ongoing Active Event Operation]

Select the operation to be performed during an active event. This can only be set when [Active Event Operation] is set to [Enable].

If [Enable] is set, [Video Record] and [E-mail Notification] will be executed according to their settings during the active event.

[Preset] R13 R11 M50 H761

If you specify a preset, the camera angle will automatically move to the preset location when an external device input event is triggered.

It is necessary to set presets beforehand with [Camera] > [Preset] (P. 131).

Important R13 R11 M50 H761

When the camera is moved to a preset position specified in the [Preset] settings, camera control privileges are released, even if the user has obtained those camera control privileges using the Camera Viewer or other camera control applications.

[Video Record]

Select whether to record video depending on the event.

If you select [Enable] and an external device input event is triggered, video will be transmitted to the recording destination specified in [Video Record] > [Upload] > [Video Record Action] (P. 158).

[E-mail Notification]

Select whether to send an e-mail notification depending on the event.

If [Enable] is selected, e-mail notification will be performed when an external device input event is triggered.

To use e-mail notification, you must set [Video Record] > [E-mail Notification] (P. 162) beforehand.

[External Device Output for Active Event]

Select the actions of external device output (1 or 2) when an active event is triggered.

[External Device Output for Inactive Event]

Select the actions of external device output (1 or 2) when an inactive event is triggered.

[Audio Playback at Active Event]

If you select [Enable], the sound clip specified in [Sound Clip] will play back at active events for the external device input.

[Audio Playback at Inactive Event]

If you select [Enable], the sound clip specified in [Sound Clip] will play back at inactive events for the external device input.

[Sound Clip]

Select the sound clip when [Audio Playback at Active Event] or [Audio Playback at Inactive Event] has been set to [Enable].

You must register the sound clip with Sound Clip Upload 1 to 3 (P. 150) in [Video and Audio] > [Audio] in advance.

[Volume]

Enter the volume for the sound clip.

[Day/Night Mode Switching]

Select the Day/Night Mode switching behavior when an external device input event is triggered.

When [Switch to Day Mode] is set, switches to Day Mode when an active event is triggered, and switches to Night Mode when an inactive event is triggered.

When [Switch to Night Mode] is set, switches to Night Mode when an active event is triggered, and switches to Day Mode when an inactive event is triggered.

**Important**

- When [Camera] > [Initial Settings] > [Day/Night] is set to [Auto] (P. 119), [Day/Night Mode Switching] will not happen when an external device input event is triggered.
- When the [Day/Night Mode Switching] settings switch Day/Night Mode, camera control privileges are released, even if the user has obtained those camera control privileges using the Camera Viewer or other camera control applications.

[Event] > [Audio Detection]

Abnormal Audio Input Triggered Operation Settings

R13 R11 M50 H65x M641 H761 H751 M741

Audio input from the microphone connected to the camera, such as loud noises or screams, or when expected audio input ceases, can trigger operations such as video recording or e-mail notification.

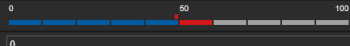
Audio Detection		Apply	Clear
Volume Detection			
Volume Detection Event	Enable		
Detection Conditions	The reference volume level or above		
Reference Volume Level 1 - 100	50		
Current Volume Level	0  100		
Detection Condition Duration (sec) 0 - 10	0		
ON Event Operation	Enable		
OFF Event Operation	Disable		
Ongoing ON Event Operation	Disable		
Preset	None		
Video Record	Disable		
E-mail Notification	Disable		
External Device Output for ON Event	Disable		
External Device Output for OFF Event	Disable		

The following settings can be configured here.

- Volume Detection
- Scream Detection

Scream Detection	
Scream Detection Event	Enable
ON Event Operation	Enable
Preset	None
Video Record	Disable
E-mail Notification	Disable
External Device Output for ON Event	Disable

Important

For notes on use of audio detection, please refer to “Precautions for Built-In Camera Functions and Included Software” (P. 10) in “Safety Precautions”.

Note

You can check the audio detection status on the [Event and Input/Output] menu of the Camera Viewer (P. 83).

Volume Detection

A volume detection event will be triggered when audio input volume is detected exceeding or falling below the reference volume setting.

Set the conditions for triggering a volume detection event and the operations to perform according to an event.

Important

Volume detection is temporarily disabled when an event causes the playback of a sound clip or when audio is transmitted from the Viewer.

[Volume Detection Event]

Select whether to use volume detection event.

[Detection Conditions]

Select the criteria for triggering a volume detection event.

[Reference Volume Level]

Enter the reference volume level to be used for detection.

Set the reference volume level by performing an actual test while checking [Current Volume Level] before configuring the setting.

[Current Volume Level]

The current volume level is displayed on the status bar.

The level set in [Reference Volume Level] is indicated by a red mark. Volume below the reference level is displayed in blue, that above the reference level is displayed in red.

[Detection Condition Duration (sec)]

When the status meeting the volume detection criteria has continued for the specified duration or longer, an ON event is triggered.

[ON Event Operation]

If [Enable] is set, [Preset], [Video Record] and [E-mail Notification] will be executed according to their settings when a volume detection event is triggered (ON event).

[OFF Event Operation]

If [Enable] is set, [Preset], [Video Record] and [E-mail Notification] will be executed according to their settings when a volume detection event is completed (OFF event).

[Ongoing ON Event Operation]

Select the operation to be performed during an ON event. This can be set when [ON Event Operation] is set to [Enable]. If [Enable] is selected, [Video Record] and [E-mail Notification] will be executed according to their settings during the volume detection event.

[Preset] R13 R11 M50 H761

If you specify a preset, the camera angle will automatically move to the preset location when a volume detection event is triggered.

It is necessary to set presets beforehand with [Camera] > [Preset] (P. 131).

**Important** R13 R11 M50 H761

When the camera is triggered by a volume detection event and moved to a preset position specified in the [Preset] settings, camera control privileges are released, even if the user has obtained those camera control privileges using the Camera Viewer or other camera control applications.

[Video Record]

Select whether to record video depending on the volume detection event.

If you select [Enable] and a volume detection event is triggered, video will be transmitted to the recording destination specified in [Video Record] > [Upload] > [Video Record Action] (P. 158).

[E-mail Notification]

Select whether to send an e-mail notification depending on the volume detection event.

If you select [Enable] and a volume detection event is triggered, an e-mail notification will be sent.

To use e-mail notification, you must set [Video Record] > [E-mail Notification] (P. 162) beforehand.

[External Device Output for ON Event]

Select the actions of the external device output (1 or 2) when an ON event is triggered.

[External Device Output for OFF Event]

Select the actions of the external device output (1 or 2) when an OFF event is triggered.

Scream Detection

A scream detection event is triggered when sounds from someone, such as a scream or cry, are detected.

You can also set the operations to perform depending on the scream detection event.

**Important**

- Scream detection detects abnormal sound in relatively quiet environments. Detection is difficult in noisy environments.
- The scream detection is not a voice recognition function.
- Detection may be difficult if an excessively loud scream is input.
- Detection may be difficult if the duration of the scream is short.
- Detection may be temporarily difficult if the same sound is input repeatedly multiple times.

[Scream Detection Event]

Select whether to use scream detection event.

[ON Event Operation]

If [Enable] is set, [Preset], [Video Record] and [E-mail Notification] will be executed according to their settings when a scream detection event (ON event) is triggered.

[Preset] R13 R11 M50 H761

If you specify a preset, the camera angle will automatically move to the preset location when a scream detection event is triggered.

It is necessary to set presets beforehand with [Camera] > [Preset] (P. 131).



Important R13 R11 M50 H761

When the camera is triggered by a scream detection event and moved to a preset position specified in the [Preset] settings, camera control privileges are released, even if the user has obtained those camera control privileges using the Camera Viewer or other camera control applications.

[Video Record]

Select whether to record video depending on the scream detection event.

If you select [Enable] and a scream detection event is triggered, video will be transmitted to the recording destination specified in [Video Record] > [Upload] > [Video Record Action] (P. 158).

[E-mail Notification]

Select whether to send an e-mail notification depending on the scream detection event.

If you select [Enable] and a scream detection event is triggered, an e-mail notification will be sent.

To use e-mail notification, you must set [Video Record] > [E-mail Notification] (P. 162) beforehand.

[External Device Output for ON Event]

Select the actions of the external device output (1 or 2) when an ON event is triggered.

[Event] > [Timer] Timer Triggered Operation Settings

The timer function can generate events that can trigger operations, such as video recording and e-mail notifications, at regular intervals.

You can set the following two types of timers.

- 24 hours continuous from specified time
- Within specified time only

Either type can be set to trigger timer events at regular intervals.

Timer		Apply	Clear
Timer 1			
Timer Event	Enable		
24-Hour Continuous Settings	Disable		
Start Time <small>hh:mm</small>	00:00		
End Time <small>hh:mm</small>	00:00		
Repeat Interval	None		
Operation			
Start Time Preset	None		
Video Record	Disable		
E-mail Notification	Disable		
External Device Output	Disable		
Day/Night Mode Switching	Disable		

The following settings can be configured here.

- Timer 1 to 4
- Operation

Timer 2	
Timer Event	Disable
Timer 3	
Timer Event	Disable
Timer 4	
Timer Event	Disable

Timer 1 to 4

You can register up to four timer events.

[Timer Event]

Select whether to use a timer event.

[24-Hour Continuous Settings]

When set to [Enable], the timer event will be repeated at the interval in [Repeat Interval] for 24 hours, starting from the time specified in [Start Time].

When set to [Enable], only [Video Record] operations can be performed.

[Start Time]

Enter the start time of the timer event in 24-hour format. The timer event will be triggered at the start time.

[End Time]

When [24-Hour Continuous Settings] is set to [Disable], enter the end time of the timer event in the 24-hour format.

[Repeat Interval]

Select a repeat interval for timer events. The timer event will be triggered at the selected intervals.

Operation

Set the operations to be performed when timer events are triggered.

[Start Time Preset] **R1x** **M50** **H76x**

When [24-Hour Continuous Settings] is set to [Disable] and you specify a preset, the camera angle will automatically move to the preset location at the time set in [Start Time].

It is necessary to set presets beforehand with [Camera] > [Preset] (P. 131).



Important **R1x** **M50** **H76x**

When the camera is moved to a preset position specified in the [Start Time Preset] settings, camera control privileges are released, even if the user has obtained those camera control privileges using the Camera Viewer or other camera control applications.

[Video Record]

Select whether to record video depending on the timer event.

If you select [Enable] and a timer event is triggered, video will be transmitted to the recording destination specified in [Video Record] > [Upload] > [Video Record Action] (P. 158).

[E-mail Notification]

When [24-Hour Continuous Settings] is set to [Disable], select whether to send an e-mail notification depending on the timer event.

If [Enable] is selected, e-mail notification is performed when a timer event is triggered.

To use e-mail notification, you must set [Video Record] > [E-mail Notification] (P. 162) beforehand.

[External Device Output] **R13** **R11** **M50** **H65x** **M641** **H761** **H751** **M741**

When [24-Hour Continuous Settings] is set to [Disable], select the actions of the external device output (1 or 2) at [Start Time] and [End Time] of a timer.

[Repeat Interval] is not supported.

[Day/Night Mode Switching]

When [24-Hour Continuous Settings] is set to [Disable], select the Day/Night Mode switching behavior when a timer event is triggered. This can only be set with [Timer 1].

Select [Switch to Day Mode] to switch to Day Mode at the start time, and Night Mode at the end time.

Select [Switch to Night Mode] to switch to Night Mode at the start time, and Day Mode at the end time.

[Repeat Interval] is not supported.



Important

- If you set [Start Time] and [End Time] and select a preset with [Start Time Preset], the Day/Night setting in [Camera] > [Preset] > [Camera Settings] > [Day/Night] (P. 131) is given priority. Therefore, even if you set [Day/Night Mode Switching] to [Switch to Day Mode] or [Switch to Night Mode], the [Day/Night Mode Switching] setting will be disabled if the opposite setting has been configured in [Preset] > [Camera Settings]. **R1x** **M50** **H76x**
- When [Day/Night] in [Camera] > [Initial Settings] is set to [Auto] (P. 119), [Day/Night Mode Switching] will not happen when a timer event is triggered.
- When the [Day/Night Mode Switching] settings switch Day/Night Mode, camera control privileges are released, even if the user has obtained those camera control privileges using the Camera Viewer or other camera control applications.

[Event] > [Intelligent Function] - Overview -

Intelligent Function

The Intelligent Function records video, sends e-mail notifications, plays audio and starts other operations when it detects changes in the video due to subject movement.

The Intelligent Function has the following modes.

- Video Detection
- Auto Tracking **R1x**
- Audio Detection **R13 R11 M50 H65x M641 H761 H751 M741**

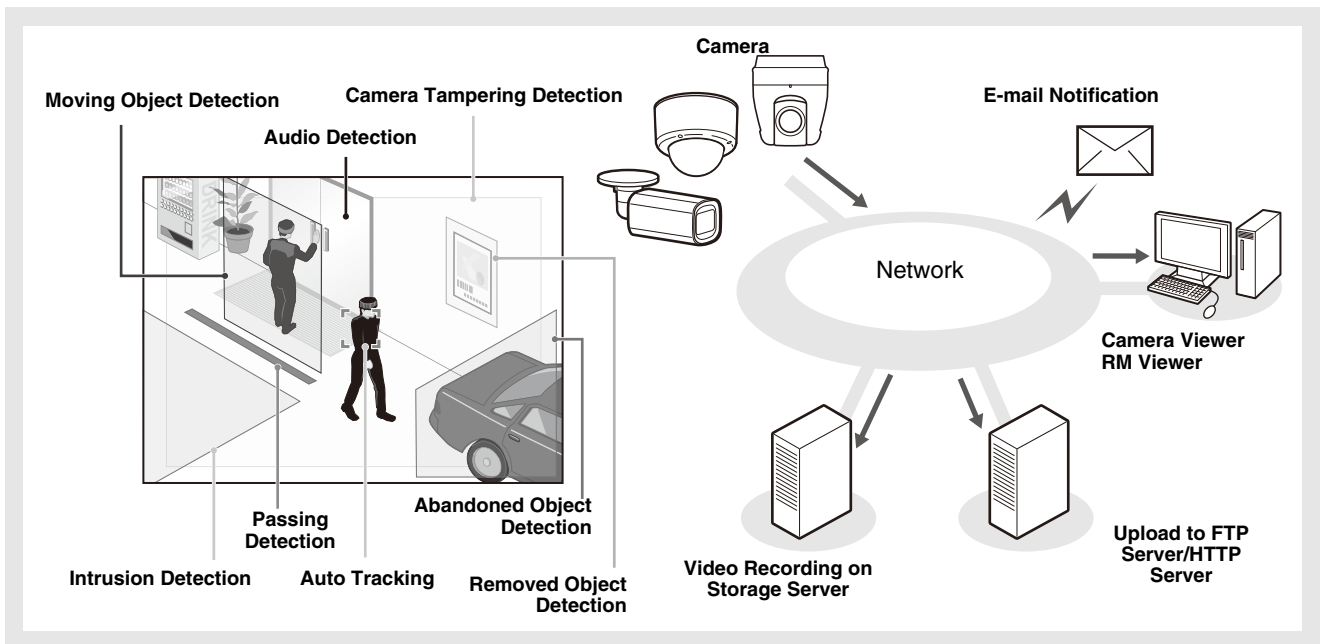

Notes on Use of This Camera

The Intelligent Function is not suitable for applications where high reliability is required. If constant and maximum reliability is required for surveillance it is not recommended that you use this function. Canon shall assume no liability for any accident, loss or other undesirable outcomes resulting from Intelligent Function operations.

Video Detection

Detects changes to video in a specified area. There are six types of detection to suit your needs.

Moving Object Detection

Detects moving objects. This function can be used to detect visitors or suspicious individuals.

Moving object detection is triggered while moving objects are inside the detection area.

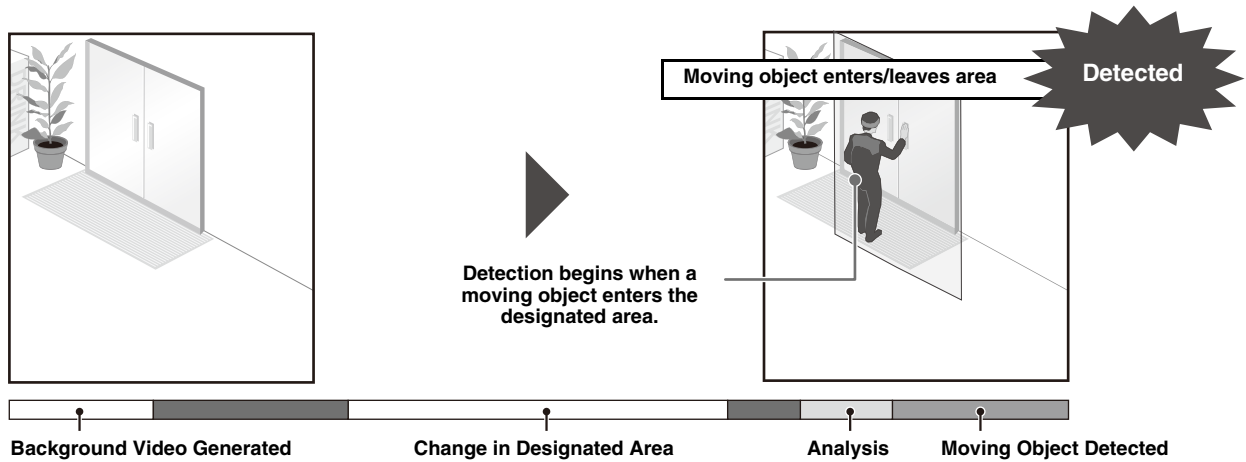

Abandoned Object Detection

Detect objects that are carried in and abandoned for a certain duration. This function can be used to detect suspicious objects that have been left behind. Abandoned object detection is triggered when an object is left in the detection area for a specified duration.

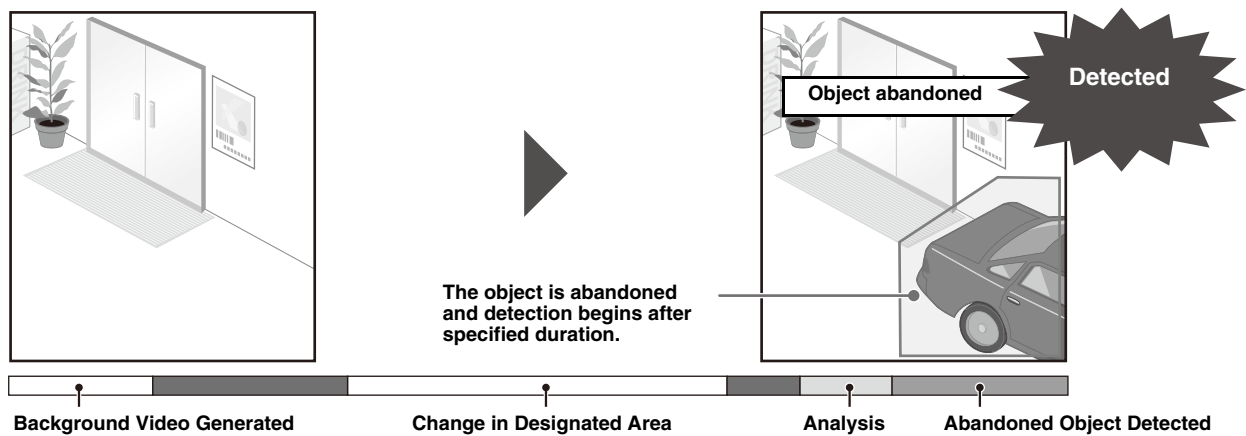

Removed Object Detection

Detect objects that have been removed. This can be used to detect actions such as the taking away of valuables.

Removed object detection is triggered when an object is removed from the detection area for a specified duration.

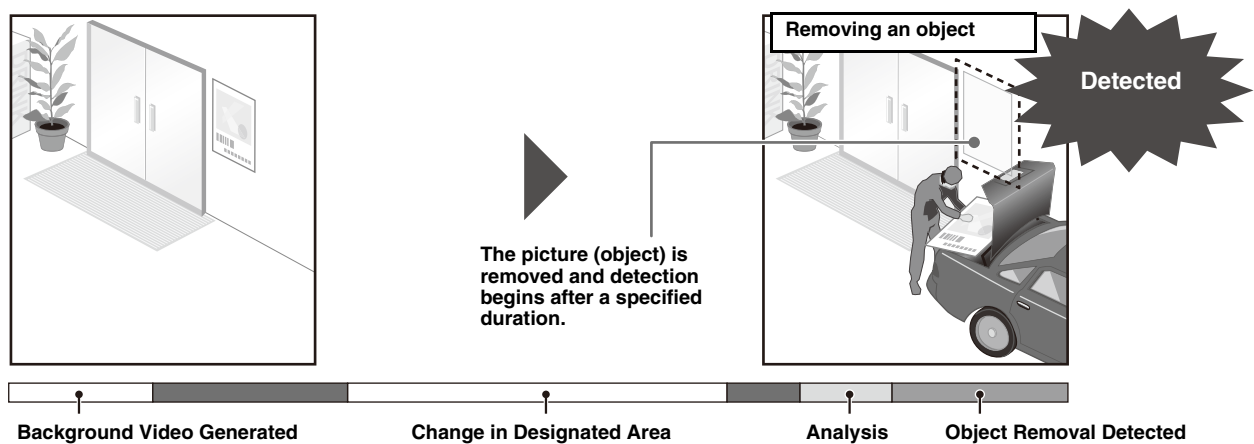

Camera Tampering Detection

Detect when capture is being disrupted. This can be used to detect when the camera orientation is changed or the video display is obscured with spray, etc. Camera tampering detection is triggered when an area exceeding a specified ratio of change is continuously altered.

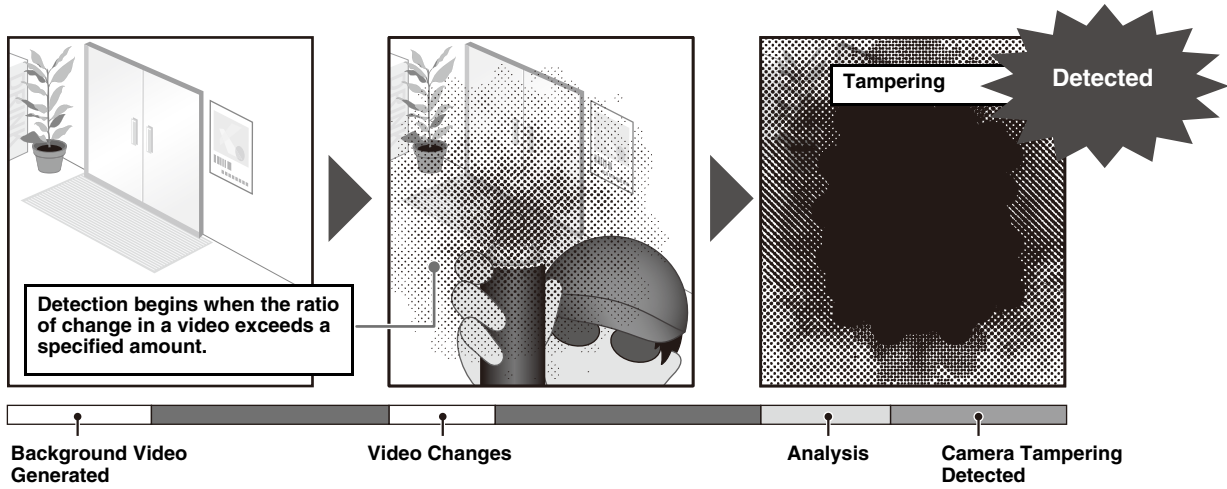

Passing Detection

Detect when a person or moving object crosses a specified line.

This determines that an object is passing when the decision point of the object detection frame crosses a detection line.

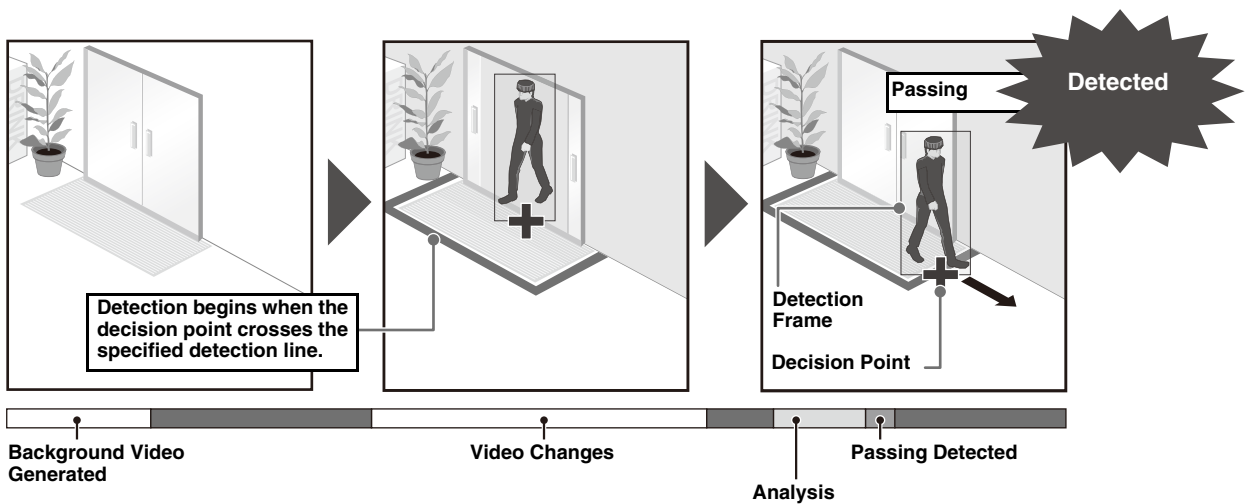

Intrusion Detection

Detect when a person or moving object crosses a specified area. This can be used to detect actions such as when someone climbs over a barrier and enters a restricted area in a museum, etc. This determines that an object is entering when the decision point of the object detection frame enters the detection area and the specified duration has elapsed.

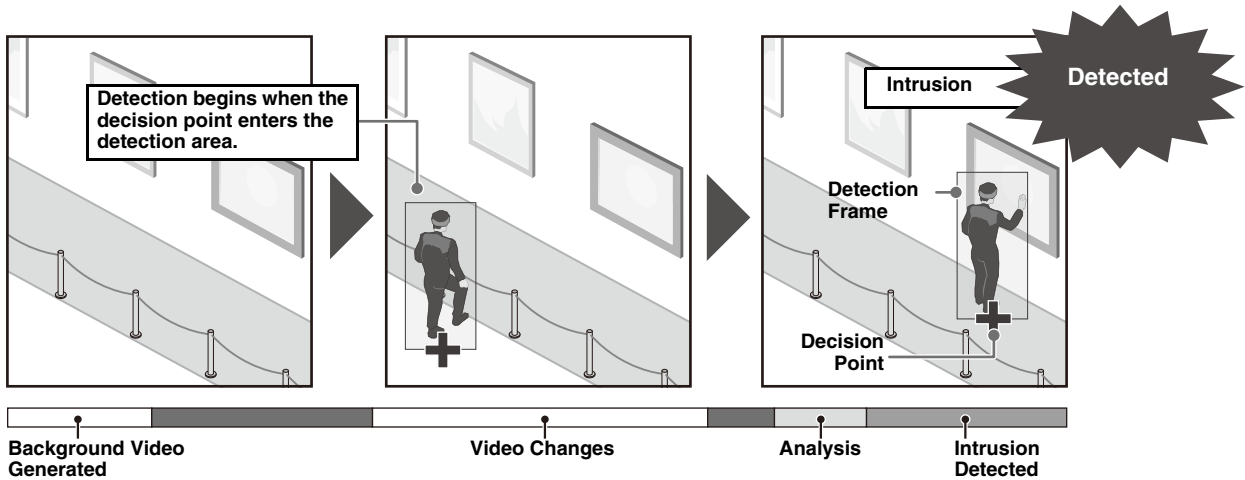

Auto Tracking

R1x

The camera automatically tracks an object when it is detected moving in a detection area. This allows monitoring movement, such as of suspicious persons.

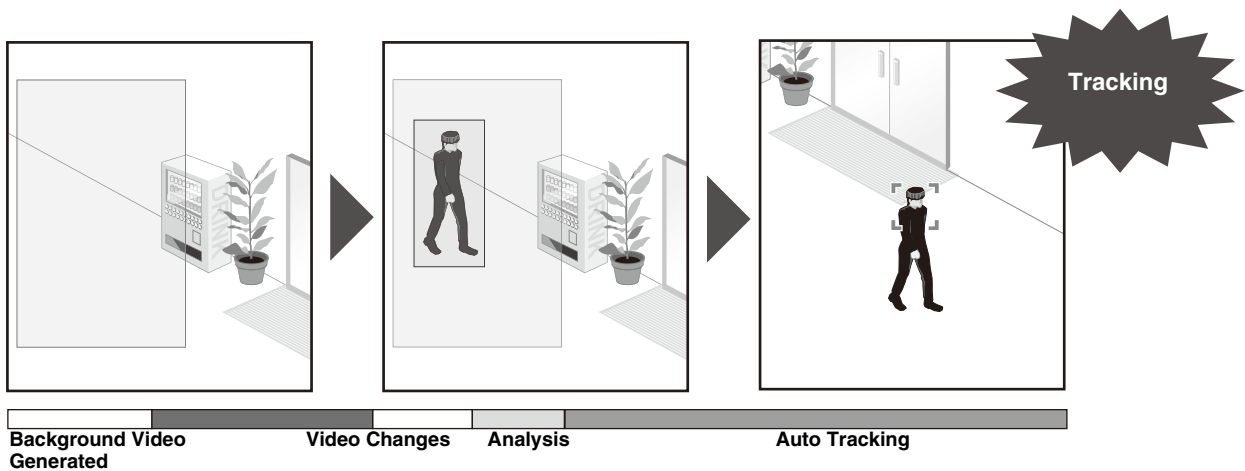

Audio Detection

R13 R11 M50 H65x M641 H761 H751 M741

Detects audio input to the camera. There are two types of detection.

These are set with [Event] > [Audio Detection] (P. 166), not with [Intelligent Function].

[Volume Detection]: Detects when volume level exceeds or falls below a reference volume.

[Scream Detection]: Detects screams or cries from people.

Notes on Intelligent Function Settings and Operations

- When setting the Intelligent Function, do an actual detection/tracking test to confirm that detection will be performed correctly.
- If a sudden change in lightness or darkness occurs within the entire screen, proper detection may not be possible for up to five minutes. When tracking, the effect will be visible as soon as there is change in the scene.
- Detection/tracking will not be performed while the Intelligent Function is restarting.
- If the camera is operated while configuring or using the Intelligent Function, [Restarting intelligent function. Please wait.] is displayed and the Intelligent Function will restart.

- If the display switches between Day mode and Night mode, [Restarting intelligent function. Please wait.] is displayed and intelligent function will restart.
- If [Basic] > [Video] > [All Videos] > [Video Size Set] settings on the Setting Page are changed, be sure to change the preset position settings (**R1x** **M50** **H76x**) and Intelligent Function settings, and check operations. The Intelligent Function may not operate, depending on the settings.

R1x **M50** **H76x**

- When the image is zoomed in (telephoto), detection may not work as expected.
- Please set the Intelligent Function again if the angle of view has changed through camera operation, or the preset/home position has changed.
- If [Status] in [Detection Settings] has [Enable] when the camera position is fixed, control privileges cannot be obtained by the Viewer connected by the user without privileges for privileged camera control or RM Viewer. Also, the preset tour will no longer run.
- If you use a preset registered with the digital zoom, the camera position at registration may not be able to be reproduced with a high degree of accuracy. Therefore, it is recommended that you use a preset registered in the optical zoom area for the intelligent function.

■ Difficult-to-Detect Subjects

The following subjects may not be detected/tracked, or may result in erroneous detection/tracking.

- Objects or areas where there is little contrast in color or brightness with the background may not be detected/tracked.
- Small objects and changes on the screen may not be detected/tracked.
- Partial or entire changes in brightness on the screen may trigger detection/tracking.
- When there are multiple overlapping objects, there may be a change in detection. For example, objects passing may either not be detected or the timing of detection may be incorrect.
- When there are large numbers of objects in the scene, objects may not be properly detected/tracked.

R13 **R12**

- Objects with little movement may not be tracked.
- Objects directly below the camera may take time to be tracked.
- Areas with bright reflections or selected areas that are very bright, can result in an object not probably being tracked.

Registering Presets

R1x **M50** **H76x**

It is strongly recommended that you register the camera angle as a preset in advance and lock the camera to that position when using video detection. It is also recommended that the angle of view that captures targeted objects at a larger ratio be used.

For details on preset registration, please refer to “[Camera] > [Preset] Registering Presets” (P. 131).

Selecting the Intelligent Function Operation Mode

R1x

Video detection and auto tracking cannot be used simultaneously. You can select which one to use on the Setting Page for the intelligent function.

Note

The applied settings are retained even if you change operation modes.

- 1 Select [Video Detection] or [Auto Tracking].

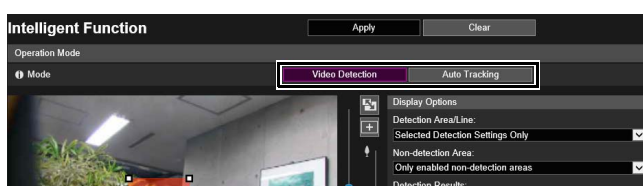



Important

[Video Detection] and [Auto Tracking] are exclusive of each other. Only the selected mode operates, the other is disabled. In addition, if you change to the other operation mode without clicking [Apply], settings changed in the current mode are lost. Be sure to click [Apply] to save the changed settings.

2 Read the displayed message, and click [OK] or [Cancel].

The currently selected operation mode changes to purple.

3 Set the selected operation mode.

For [Video Detection], please refer to “[Event] > [Intelligent Function] - Video Detection -” (P. 177) to configure video detection settings.

For [Auto Tracking], please refer to “[Event] > [Intelligent Function] - Auto Tracking -” (P. 194) to configure Auto Tracking settings.

[Event] > [Intelligent Function] - Video Detection -

In video detection, select the type to detect, and set the tracking area for video changes while checking images on the camera. You should also set which operations (e-mail notification, record video, playing audio from the speaker connected to the camera) should be carried out when changes are detected.

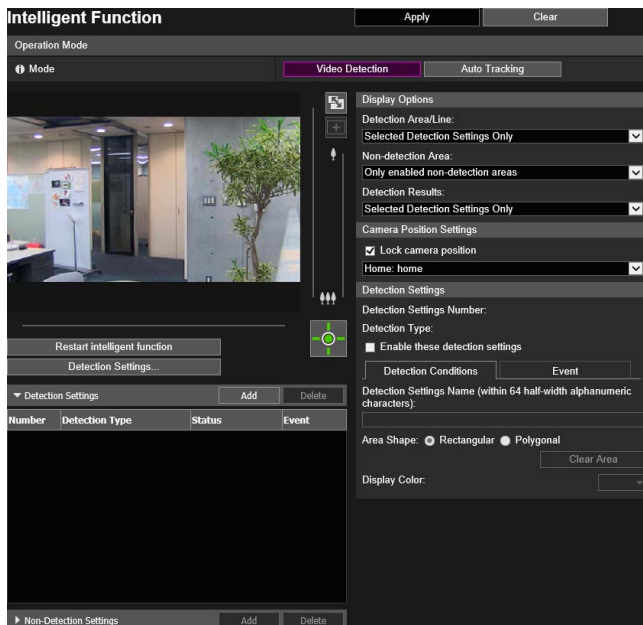

The following settings can be configured here.

- Operation Mode
- Detection Settings (List)
- Non-detection Area Settings (List)
- Display Options
- Camera Position Settings
- Detection Settings (Details)
- Non-detection Settings (Details)

Steps for Configuring Video Detection

Set an area where changes in video are detected and an area where changes in video are not detected (non-detection area) as necessary.

■ Configuring the Detection Area

The following are the basic steps for configuring a detection area. For details on settings for each type of detection, please refer to “Configuring Detection Criteria ([Detection Conditions] Tab)” (P. 181).

- 1 Select [Lock camera position] in [Camera Position Settings], then select a preset. **R1x M50 H76x**

For details on how to adjust presets, please refer to “[Camera] > [Preset] Registering Presets” (P. 131).

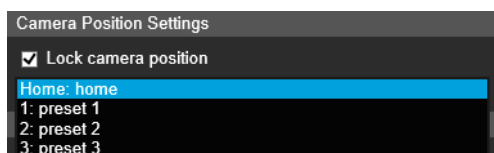

Note

You can select presets that meet the following conditions.

- Presets configured within the view restrictions
- Presets with pan, tilt and zoom setting values (not blank) configured in [Register Preset] (P. 133) **R1x M50**
- Presets with zoom setting values (not blank) configured in [Register Preset] (P. 133) **H76x**

2 Click [Add] in [Detection Settings].



3 Select [Detection Settings Number] (1 to 15) and [Detection Type] for the detection setting to be added.

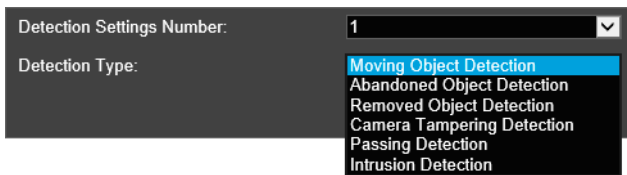

 Note

You can register up to 15 detection settings.

4 Click [OK].

The detection settings added to [Detection Settings] are displayed and [Enable these detection settings] is selected.

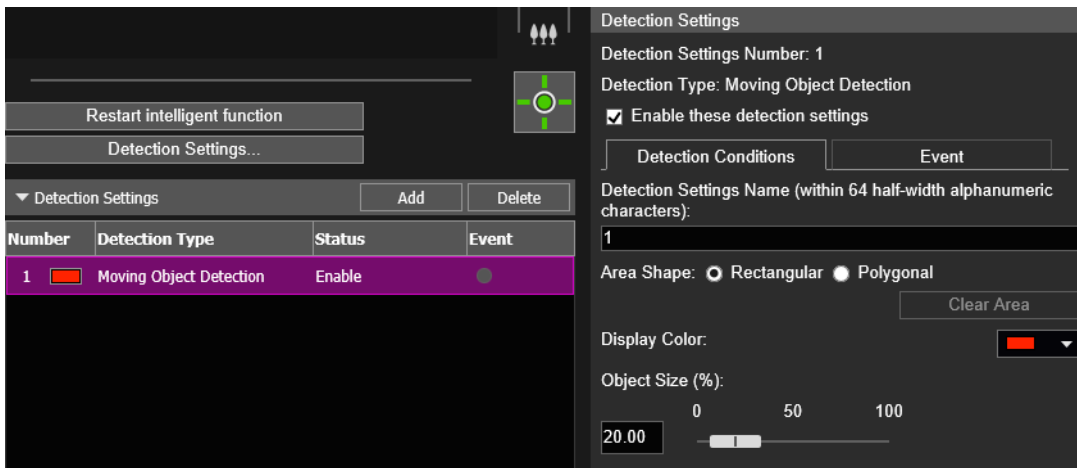

 Note

- To disable the detection settings, clear the [Enable these detection settings] checkbox.
- Enter the [Detection Settings Name] if necessary (P. 182).
- To delete detection area settings, select the detection area settings to delete and click [Delete] in Detection Settings (List).

5 Configure the detection criteria.

Set criteria in the video display area or [Detection Conditions] tab (P. 181). The detection criteria differ according to the detection type.

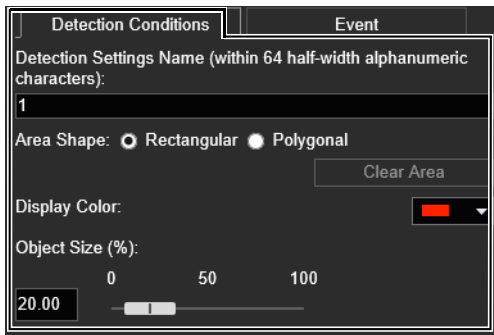

6 Configure event settings.

Set which operations to carry out for video detection in the [Event] tab (P. 199).

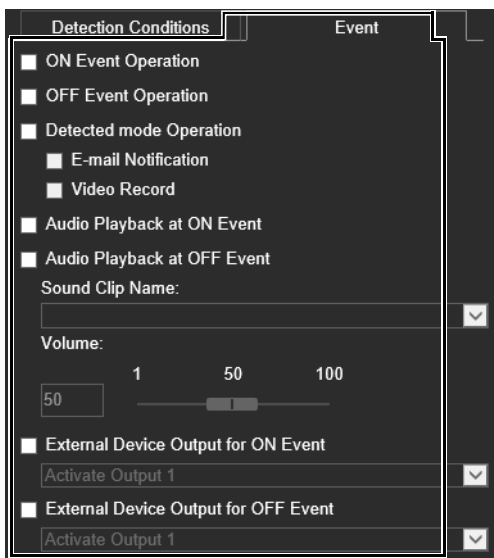

7 To register multiple detection settings, repeat steps 2 to 6.

8 Click [Apply].

The settings are saved to the camera.

Note

To restore settings, click [Clear] before applying. This discards the settings you have specified and restores the settings saved in the camera. However, note that detection settings only added to the detection setting area by clicking [Add] are all discarded.

9 Check the detection result.

You can check the detection status of the specified detection settings in video display area, the [Event] column in [Detection Settings] or the [Event and Input/Output] menu in the Camera Viewer (P. 82).

■ Setting a Non-Detection Area

You can set an area where changes are not detected, to prevent mis-detection and non-detection.

Important

- The non-detection area set in the non-detection area settings is reflected in all detection settings.
- If the area in the detection settings and the area in the non-detection area settings overlap, the non-detection settings are prioritized.

1 Click [Non-Detection Settings] to display the list of non-detection area settings.

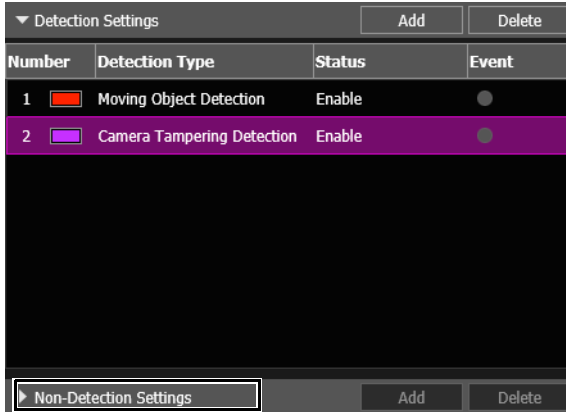

2 Click [Add].

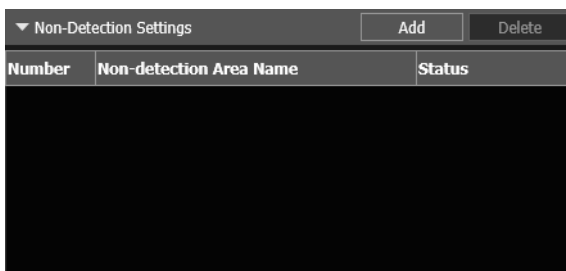

The non-detection area settings added in [Non-Detection Settings] are displayed and [Enable non-detection area] is selected.

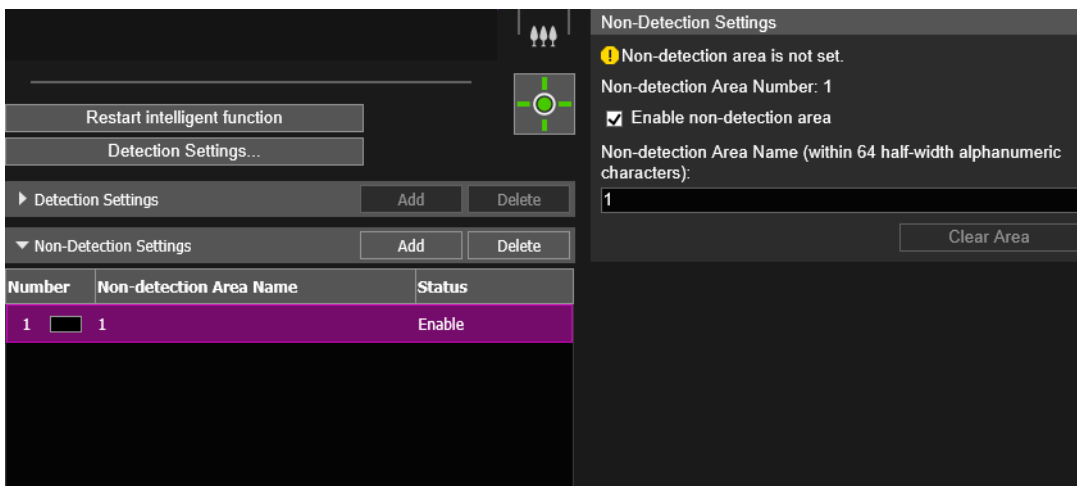

Note

- Up to five non-detection area settings can be registered.
- To disable non-detection area settings, clear the [Enable non-detection area] checkbox.
- To delete non-detection area settings, select the non-detection area settings to delete and click [Delete] in Non-detection Area Settings (List).

3 Set a non-detection area in the video display area.

Click the mouse to create a polygon. For information on the creation method, please refer to “Using [Polygonal]” (P. 182).



Note

- You can create a polygonal area with a maximum of 32 vertices. You cannot set a non-detection area with only a straight line.
- Click [Clear Area] to set the non-detection area again.
- Enter [Non-detection Area Name (within 64 half-width alphanumeric characters)] as necessary.
- The non-detection area is displayed in the video display area in black. The display color cannot be selected.

4 To register multiple non-detection areas, repeat steps 2 and 3.

5 Click [Apply].

The settings are saved in the camera.

Note

Click [Clear] to discard the settings and restore the settings saved in the camera. However, note that non-detection areas only added to the non-detection areas by clicking [Add] are all discarded.

6 Check the detection result.

The status of the specified non-detection settings can be checked in the video display area and the [Status] column in [Non-Detection Settings].

If [Enable non-detection area] is cleared, [Disable] is displayed for the [Status] column in [Non-Detection Settings], and the non-detection area is not displayed in the video display area.

Important

- Make sure to check the video display area to see whether the detection area and non-detection area are unintentionally overlapped.
- If you set the detection area and non-detection area close to each other, detection may be performed incorrectly.

Configuring Detection Criteria ([Detection Conditions] Tab)

Detection criteria is controlled and set in the video display area for each type of detection.

Important

It is recommended that you configure the detection criteria in conditions as close as possible to the actual conditions in which you will use the camera.

■ Settings Common to Each Detection Type

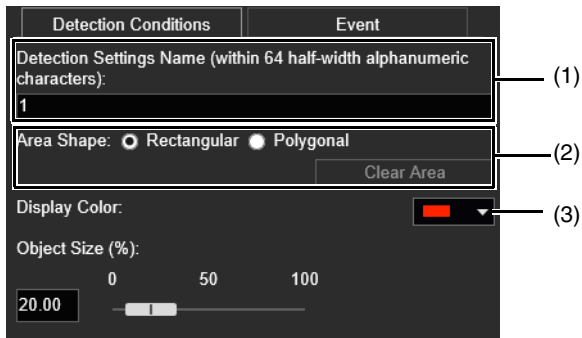

- (1) [Detection Settings Name (within 64 half-width alphanumeric characters)]
Enter a detection name. Be sure to enter a name in [Detection Settings Name (within 64 half-width alphanumeric characters)].
- (2) [Area Shape]
Configure whether the detection area is a rectangle or a free-shape polygon.

Note

You cannot select [Area Shape] for camera tampering detection.

Using [Rectangular]

Configure the detection area by moving, resizing or changing the shape of the rectangle that is displayed in the video display area.



Drag the area to move it, and drag the vertices to resize it.

Using [Polygonal]

Click the video display area to place a vertex for the polygon at the clicked position.

Place the vertices in order, then either click the first vertex again or double-click the last vertex to set the polygon detection area.



Drag the area to move it, and drag the vertices to resize it.

You can specify polygonal areas with a maximum of 32 vertices.

Note

If you change the shape of a detection area you have already configured, the area is deleted and you switch to configuring a new area.

[Clear Area]

The detection area configured with [Polygonal] is deleted.

(3) [Display Color]

Select the color for detection areas and detection lines.

How to Configure Moving Object Detection

Set the area you want to detect a moving object in as a detection area.

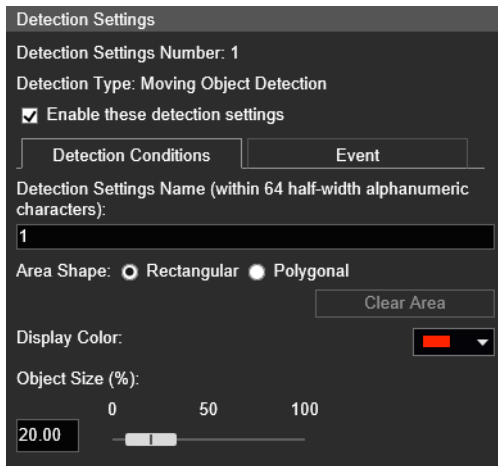

1 Select [Rectangular] or [Polygonal].

2 In the video display area, draw the area in which you would like to detect moving objects (P. 182).

3 Configure the size of the object needed for triggering detection in [Object Size (%)].

This determines how large the moving object must be in relation to the detection area you set in step 2 for motion detection to be triggered.

When the setting values or slider is changed, an indicator representing the object size is displayed for one second in the center of the video display area allowing you to check the size ratio while specifying the setting.

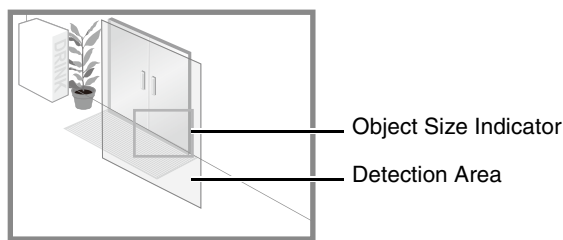

Detection Status for Moving Object Detection

All moving objects detected are displayed with profile lines.

If a moving object is smaller than [Object Size (%)], its profile lines are white.

If the moving object is larger than [Object Size (%)], its profile lines take on the same color as the detection area indicating “detected” status has been triggered.

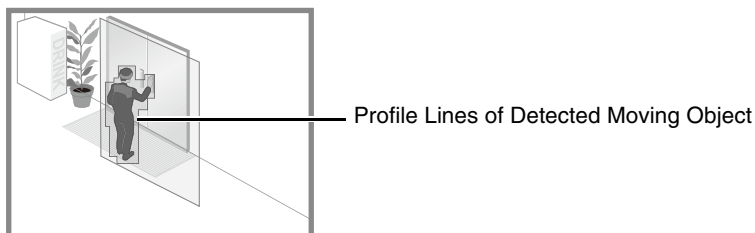

Note

If an object is placed in or removed from the moving object detection area, “detected” status will be triggered for Moving Object Detection.

How to Configure Abandoned Object Detection

Set the area you want to detect an abandoned object in as a detection area.

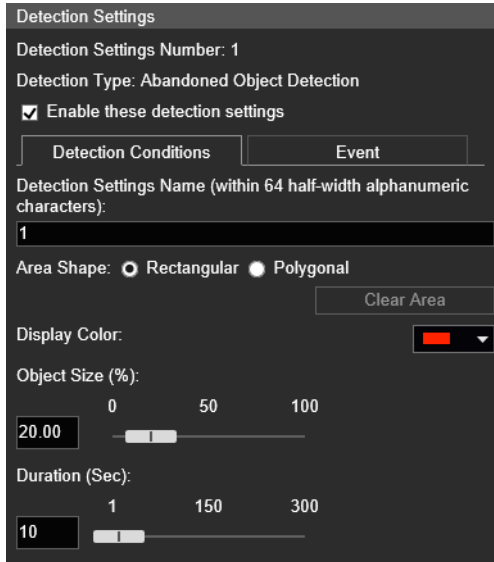

1 Select [Rectangular] or [Polygonal].

2 In the video display area, draw the area in which you would like to detect abandoned objects (P. 182).

3 Configure the size of the object needed for detection in [Object Size (%)].

This determines how large the abandoned object must be in the detection area you set in step 2 to detect as an abandoned object.

When the setting values or slider is changed, an indicator representing the object size is displayed for one second in the center of the video display area allowing you to check the size ratio while setting.

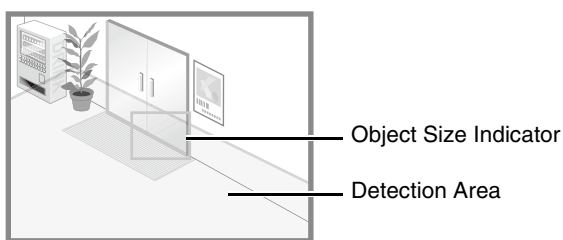

4 Configure [Duration (Sec)] for the time required for an object to be detected as an abandoned object.

Detection Status for Abandoned Object Detection

All moving objects detected are displayed with profile lines.

If [Object Size (%)] and [Duration (Sec)] are not met, profile lines are white.

If both [Object Size (%)] and [Duration (Sec)] are exceeded, the profile lines take on the same color as the detection area, indicating that “detected” mode has been triggered.

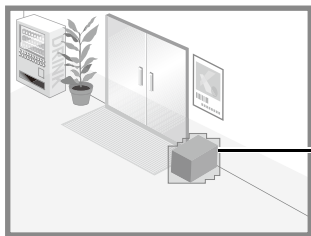

Profile lines of detected abandoned object

How to Configure Removed Object Detection

Set an area around the target objects, for Removed Object Detection. The following methods are available for configuring removed object detection.

- Setting a broad area for detecting the removal of objects
- Specifying the profile lines of objects for removal detection

If you cannot detect the intended objects using one of these methods, use the other method.

Setting a Broad Area for Detecting Removed Objects

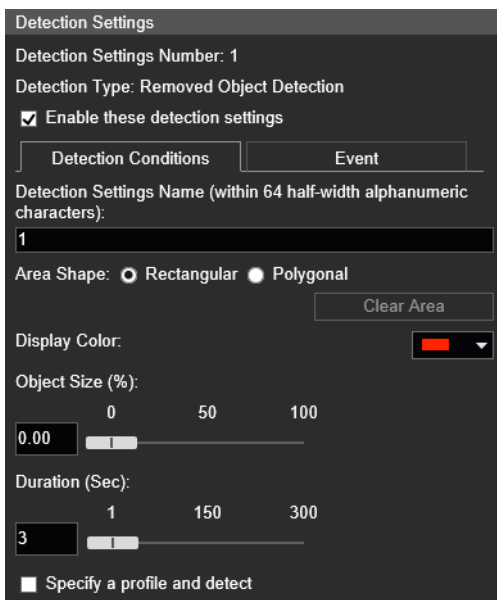

Configure the following settings with the [Specify a profile and detect] checkbox cleared.

- 1 Select [Rectangular] or [Polygonal].
- 2 In the video display area, draw a broad area to detect removed objects (P. 182).

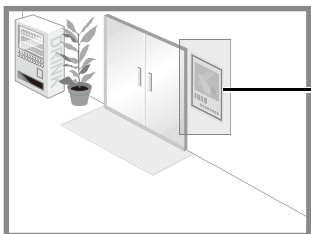

Set detection area

- 3 Configure the size of the object needed for triggering detection in [Object Size (%)].

Set how large an object that is removed must be to trigger removed object detection in the detection area set in step 2.

When the setting values or slider is changed, an indicator representing the object size is displayed for one second in the center of the video display area allowing you to check the size ratio while specifying the setting. A removed object is detected when the setting value in [Object Size (%)] is exceeded.

4 Configure [Duration (Sec)] for time required for an object to be detected as a removed object.

5 Click [Apply].

Important

- A removed object may not be detected in the following cases.
 - When long and thin objects are removed
 - When the same object is placed continuously and some of the objects are removed
 - When objects of the same shape are placed together and some of the objects are removed
- If the video inside the detection area changes without an object being removed, it may be misdetected as a removed object.

Specifying the Profile Lines of Objects for Removal Detection

1 Select [Specify a profile and detect].

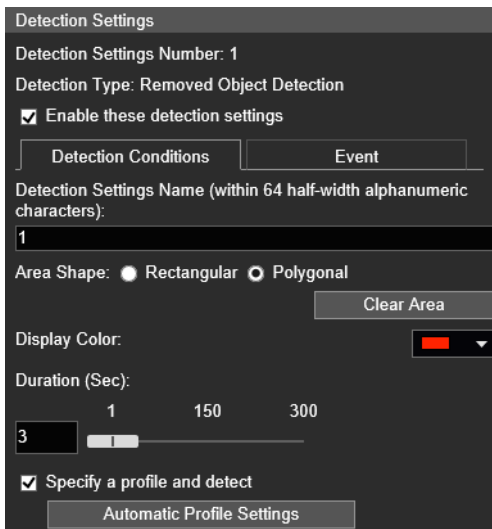

Detection Settings

Detection Settings Number: 1

Detection Type: Removed Object Detection

Enable these detection settings

Detection Conditions Event

Detection Settings Name (within 64 half-width alphanumeric characters):

1

Area Shape: Rectangular Polygonal

Clear Area

Display Color:

Duration (Sec):

1 150 300

3

Specify a profile and detect

Automatic Profile Settings

2 Select [Rectangular] or [Polygonal].

3 Use the video display area to configure an area along the profile lines of the object you do not want removed (P. 182).

Alternatively, set the profile lines automatically using the following procedure.

Temporarily remove the target object for removed object detection from the video display area.



Click [Restart intelligent function] (P. 200).

The background image is generated



Return the target object to its original position.



Click [Automatic Profile Settings].

A profile line of the object is drawn using a polygon with up to 32 vertices.

If there are multiple objects detected, the profile lines are drawn around the object occupying the largest area.

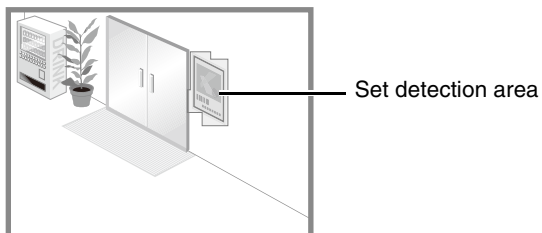

Click [Restart intelligent function] again.

Important

Set detection areas so that they precisely match the profile lines of the target object. Influence from the target object's shadow or adjacent objects may result in the target object being recognized as larger than it actually is and may not trigger removed object detection. If this occurs, reconfigure the detection area to outline the recognized target object.

4 Follow steps 4–5 in “Setting a Broad Area for Detecting Removed Objects” (P. 186).

Detection Status for Removed Object Detection

All moving objects detected are displayed with profile lines.

If you set [Object Size (%)] and [Duration (Sec)], the following occurs.

- If [Object Size (%)] and [Duration (Sec)] are not met, the profile line is displayed with a white line.
- If both [Object Size (%)] and [Duration (Sec)] are exceeded, the profile line is displayed in the same color as the detection area to indicate that something has been detected.

If removed object detection is set in [Specify a profile and detect], the following occurs.

- As long as [Duration (Sec)] is not exceeded, profile lines are white.
- When [Duration (Sec)] is exceeded, profile lines take on the same color as the detection area, indicating that an object has been removed.

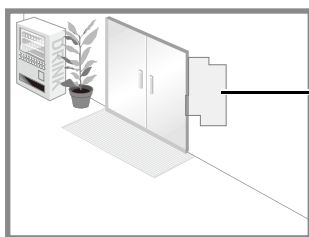

Profile lines of detected removed object

How to Configure Camera Tampering Detection

For [Camera Tampering Detection], the entire video display area is the detection area. The area cannot be changed.

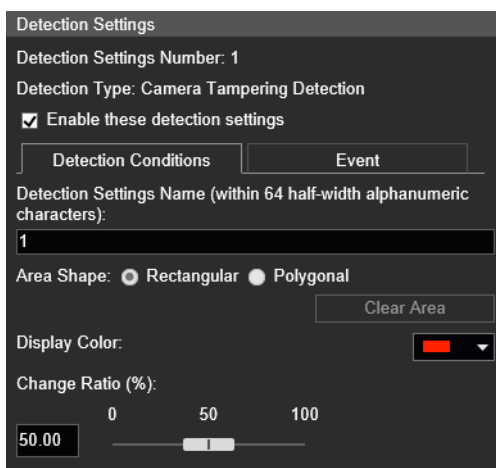

In [Change Ratio (%)], you can set the ratio of screen change for the entire video display area to determine as tampering detection.

When the setting values or slider is changed, an indicator representing the ratio of the entire video display area is displayed for one second in the center of the video display area allowing you to check while specifying the setting.

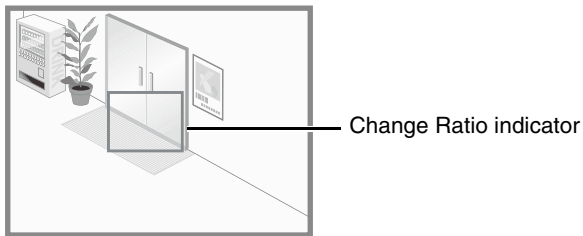

Detection Status for Camera Tampering Detection

Moving objects detected are displayed with profile lines.

If an object is smaller than [Change Ratio (%)], its profile lines are white.

If the obscured area in the video exceeds [Change Ratio (%)], profile lines take on the same color as the detection area, indicating that the camera has “detected” tampering.

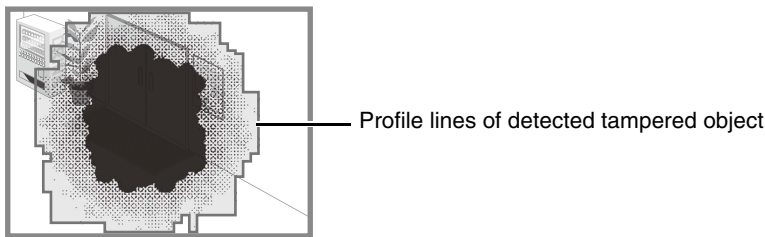

Note

Detection will not be possible for three seconds after the change ratio for camera tampering detection is changed, or when switching to camera tampering detection settings from settings for another detection mode.

How to Configure Passing Detection

The detection line for passing moving objects is determined by setting the passing direction and object decision point.

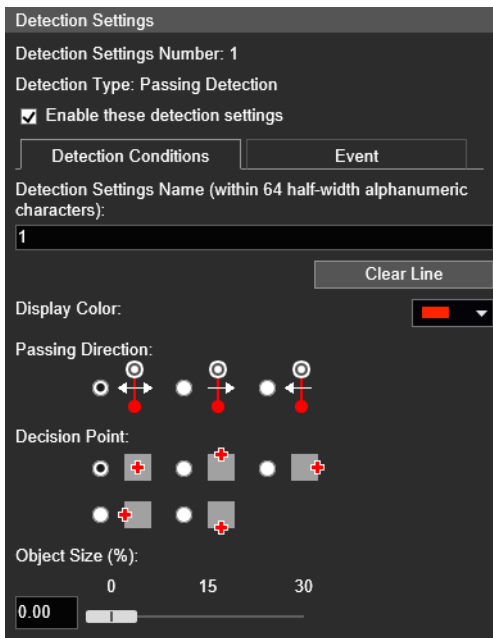

1 Follow the steps below to configure the passing detection line in the video display area.

In the video display area, click the start point of the detection line.



Click another point.

The passing detection line will be set between the start point and next point you clicked.

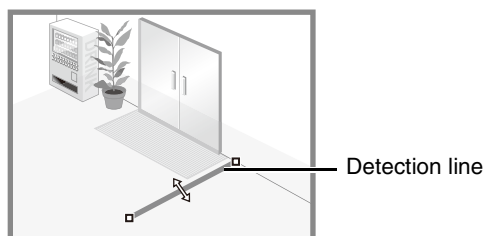

To configure a polygonal detection line, click the vertices of the line in order.

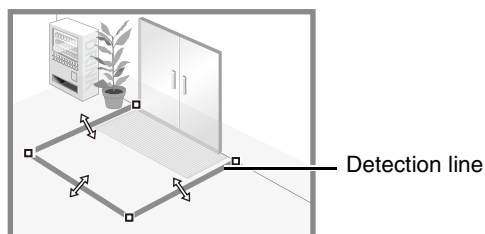

You can configure a polygonal detection line with a maximum of 32 vertices.

Click any of the set vertices.
The detection line is determined.

Note

- Even after configuring a detection line, you can drag each vertex to change the shape of the detection line and the lines between vertices to move the entire detection line.
- Click [Clear Line] to delete a detection line.

2 In [Passing Direction], select the direction for moving objects to pass the detection line.

If a moving object crosses the detection line in the selected direction, it will be detected as 'passed'.
A preview display shows the selected passing direction on the detection line in the video display area.

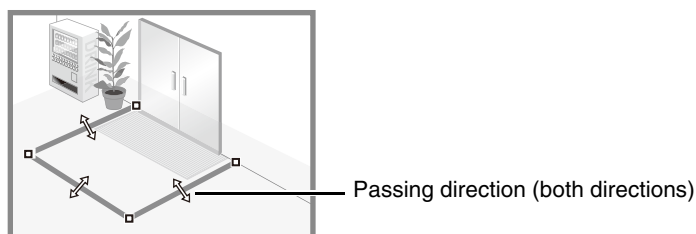

3 In [Decision Point], select the point of a moving object that will be used for triggering passing detection when the moving object crosses a detection line.

If the selected decision point crosses the detection line, it will be detected as 'passed'.
The decision point is indicated by a cross on the detection frame of the moving object.

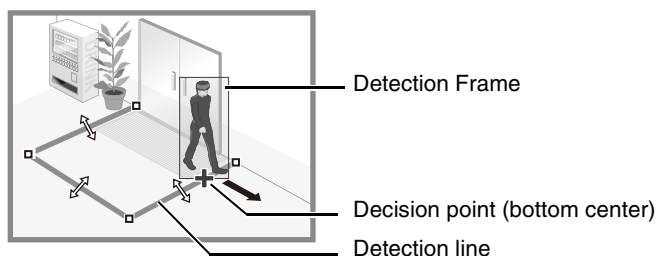

4 Configure the size of the moving object needed for triggering detection in [Object Size (%)].

Set the size ratio of moving objects for the entire screen.
If the moving object exceeds the set value for [Object Size (%)], it will be targeted for passing detection.
When the setting values or slider is changed, an indicator representing the object size is displayed for one second in the center of the video display area allowing you to check the size ratio while specifying the setting.

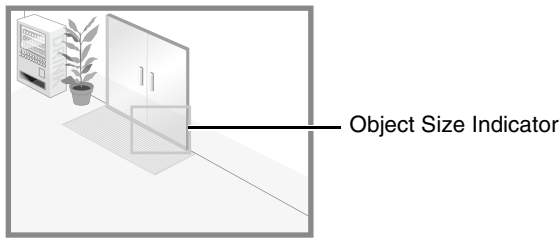

Note

A ratio of up to 30% can be set in [Object Size (%)] for passing detection.

Detection Status for Passing Detection

All moving objects detected are displayed with white profile lines.

When the [Decision Point] of a moving object that meets the [Object Size (%)] setting crosses a detection line in the direction specified in [Passing Direction], the profile line changes to the same color as the detection line, and the status becomes “detected”.

Notification of a passing detection event occurs only when the decision line is crossed. Take care in setting the operation to be performed when an event occurs.

Important

Perform a detection test after configuring passing detection to make sure the detection frame of a moving object continues to be displayed.

How to Configure Intrusion Detection

Set the area for which you want to detect intrusions.

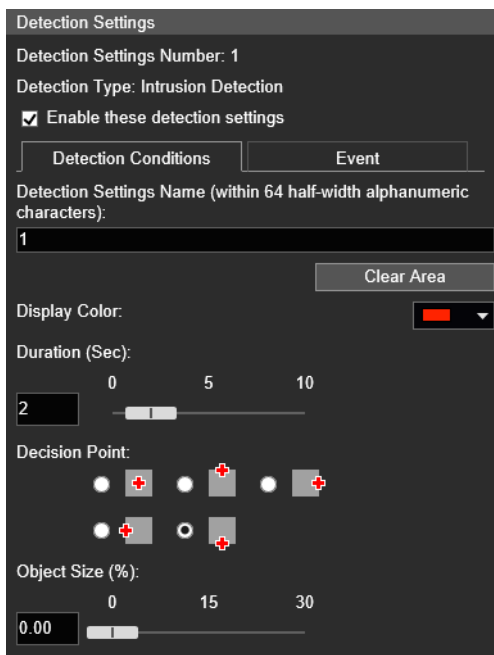

- 1 In the video display area, draw the area in which you would like to detect intruding objects (P. 182).
- 2 Configure [Duration (Sec)] for the time required for an object to enter a detection area, and be detected as an intrusion.
- 3 In [Decision Point], select the point of a moving object that will be used for triggering intrusion detection when the moving object enters a detection area.

The decision point is indicated by a cross on the detection frame of the moving object.

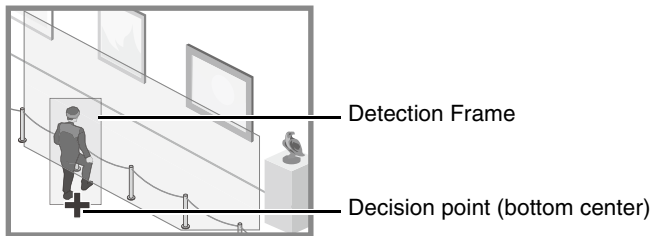

4 Configure the size of the moving object needed to trigger detection in [Object Size (%)].

Set the size ratio of moving objects for the entire screen.

When the setting values or slider is changed, an indicator representing the object size is displayed for one second in the center of the video display area allowing you to check the size ratio while specifying the setting.

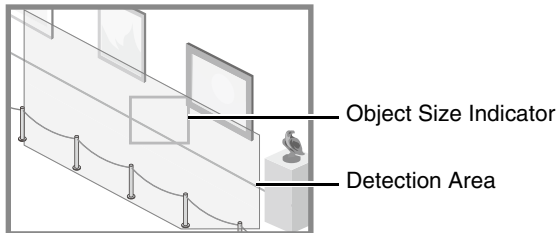

Detection Status for Intrusion Detection

All moving objects detected are displayed with profile lines.

When [Decision Point] of a moving object larger than [Object Size (%)] enters a detection area and exceeds [Duration (Sec)], its profile lines take on the same color as the detection area, indicating that “detected” mode has been triggered.

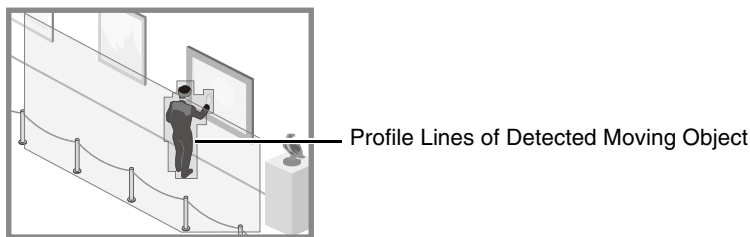

Important

After the Intrusion Detection is set, please confirm that the system continues to show profile lines of the detected moving object.







Configuring Operations for “Detected” ([Event] Tab)

Set operations to be performed upon detection of changes in a subject.

For details on settings, please refer to “Configuring Operations for “Detected” ([Event] Tab)” (P. 199).

Checking Event Status

If the intelligent function (moving object detection, abandoned object detection, removed object detection, camera tampering detection, passing detection, and intrusion detection) detects something, the event icon in that row turns green. The detection status of auto tracking can also be checked in the Event and Input/Output menu of the Camera Viewer (P. 82).

▼ Detection Settings			
Number	Detection Type	Status	Event
1	 Moving Object Detection	Enabled	
2	 Moving Object Detection	Enabled	
3	 Passing Detection	Enabled	

No.1: Video Detection Status is ON
 No.2 and 3: Video Detection Status is OFF

Displaying Settings for Detection Areas/Detection Lines, Non-Detection Area and Detection Results (Display Options)

Configure the detection area/line, non-detection area, and detection results displayed in the video display area.

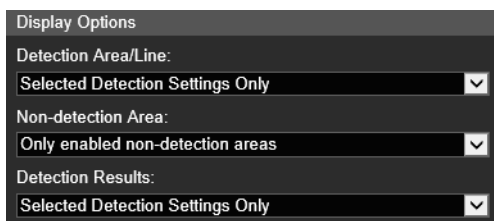

You can select the following for either [Detection Area/Line] or [Detection Results].

[Selected Detection Settings Only]

Show the detection areas/lines or detection results only for those detection settings selected in Detection Settings (List).

[All Detection Settings]

Show the detection areas/lines or detection results for all detection settings in Detection Settings (List).

[Detection Settings of the Same Type]

Show the detection areas/lines or detection results for the same types of detection settings as those selected in Detection Settings (List).

[Disable]

No detection areas/lines or detection results are displayed.

The following settings can be selected for [Non-detection Area].

[Only selected non-detection areas]

Only the non-detection areas selected in the Non-detection Area Settings (List) are displayed.

[All non-detection areas]

All the non-detection areas in the Non-detection Area Settings (List) are displayed.

[Only enabled non-detection areas]

Only the non-detection areas with the [Status] as [Enabled] in the Non-detection Area Settings (List), are displayed.

[Disable]

No non-detection areas are displayed.

Reducing Effects of Lighting Change (Detections Settings)

The Intelligent Function may not work when the entire screen is exposed to sudden changes in brightness, for example, when indoor lights are turned on or off. Changing the detection settings may reduce this effect.

- 1 Click [Detection Settings].



2 Select [Reduce effects of lighting change] checkbox.

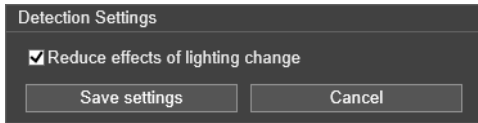

3 Click [Save settings].

The settings are saved and the Intelligent Function restarts.



Important

- It takes several seconds for the Intelligent Function to restart. No detection is performed while restarting.
- Settings in [Reduce effects of lighting change] may not work depending on the operating environment. Repeated sudden changes in brightness may also have the same effect. Perform a detection test to check whether settings work correctly.

Context Menu

Right-click on the video display area, Detection Settings (List) and Non-Detection Settings (List) to display a menu that allows you to use the following functions. Unavailable functions will be grayed out when you right-click.

[Copy detection area/line]

Copy the detection area/line of the selected detection setting to the clipboard.

[Paste detection area/line]

Paste the copied detection area/line from the clipboard to the detection setting being configured. Paste cannot be used with camera tampering detection.

Pasting a detection line is possible only when setting passing detection in the copy source and the paste target.

[Clear detection area/line]

Delete the detection area/line of the selected detection setting. If the shape of the area is rectangular, or the area is a camera tampering detection area, the area cannot be deleted.

[Copy detection condition settings]

Copy the detection criteria of the selected detection setting to the clipboard. The detection settings name and display color are not copied.

[Paste detection condition settings]

Paste the copied detection criteria from the clipboard to the detection setting being configured. Pasting is possible only if the source and the target are the same detection type.

[Copy event settings]

Copy the event settings of the selected detection setting to the clipboard.

[Paste event settings]

Paste the copied event settings from the clipboard to the detection setting being configured.

[Copy non-detection area]

Copies a non-detection area that has been set to the clipboard.

[Paste non-detection area]

Pastes a non-detection area copied to the clipboard to the non-detection area that is being set.

[Clear non-detection area]

Deletes the non-detection area that is being set.

[Event] > [Intelligent Function] - Auto Tracking -

R1x

For Auto Tracking, set the detection area for moving objects while checking the video on the computer screen. The camera is controlled so that the detected moving object appears near the center of the video display area. You can also set which operations (such as e-mail notification, recording video, or playing audio from the speaker connected to the camera) are carried out when detection occurs.

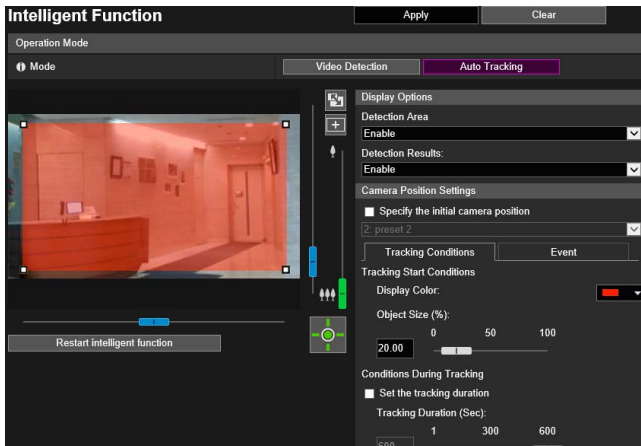

The following settings can be configured here.

- Operation Mode
- Display Options
- Camera Position Settings

Setting Auto Tracking

Use the following steps to set Auto Tracking.

- 1 Obtain camera control privileges to set Auto Tracking (P. 65).
- 2 Select [Specify the initial camera position] in [Camera Position Settings] as necessary, then select a preset.

For details on how to adjust presets, please refer to “Registering a Preset” (P. 131).

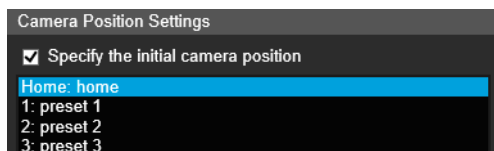

If you select [Specify the initial camera position], the camera angle will be moved to the selected preset position. The camera angle will also be moved to the selected preset position after Auto Tracking ends.

Important

It is recommended that you select [Specify the initial camera position] and configure the camera to begin auto tracking from a specified position.

Note

You can select presets that meet the following conditions.

- Presets configured within the view restrictions
- Presets with pan, tilt and zoom setting values (not blank) configured in [Register Preset] (P. 132)

3 Configure the detection area in the video display area.

Use a rectangle to specify the detection area (P. 182).

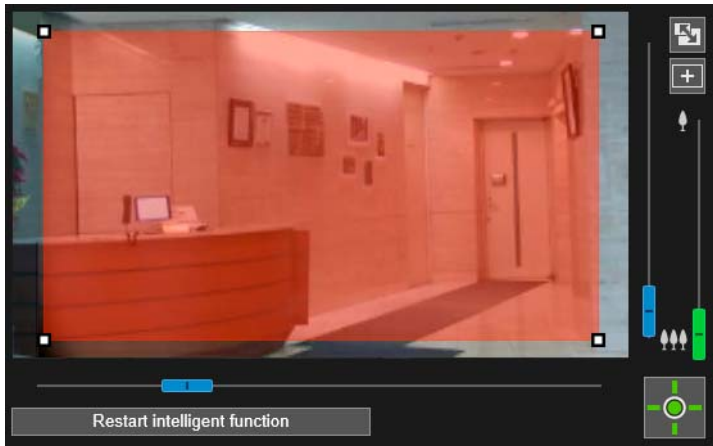

Note

The detection area is set to display within a rectangular area by default. It cannot be set to the edge of the video display area.

4 Configure the size of the moving object needed to trigger detection in [Object Size (%)] in the [Tracking Conditions] tab.

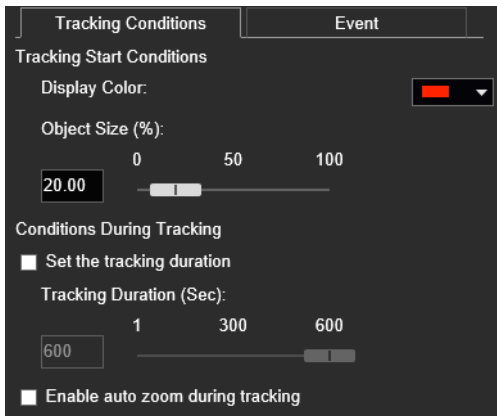

Set the size ratio of moving objects for the entire screen.

When the setting values or slider is changed, or the detection area is changed, an indicator representing the object size is displayed for one second in the center of the video display area allowing you to check the size ratio while specifying the setting.

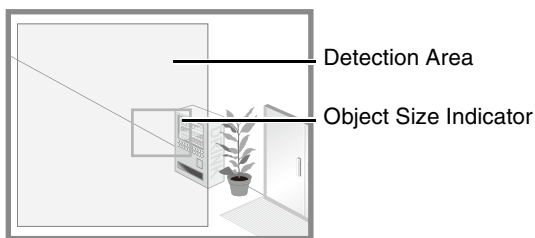

5 To configure the time to continue auto tracking, select [Set the tracking duration] and set the time in [Tracking Duration (Sec)].

When the moving object is detected, the camera automatically tracks it for the specified time.

6 To automatically zoom in on the moving object while tracking, select [Enable auto zoom during tracking].

When selected, the camera zooms in on the moving object and automatically tracks it.

7 In the [Event] tab, configure the operations to be performed when “detected” mode is triggered.

For details on settings, please refer to “Configuring Operations for “Detected” ([Event] Tab)” (P. 199).

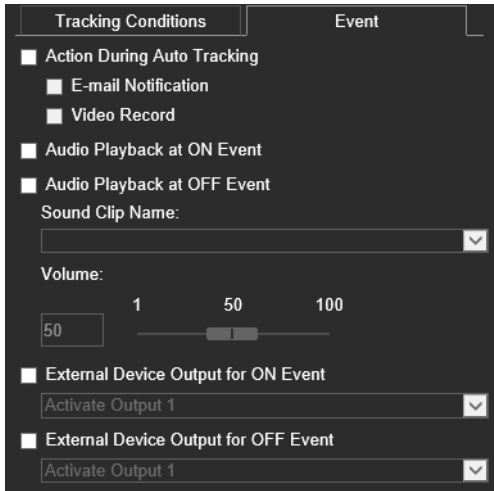

8 Click [Apply].

The settings are saved to the camera.

9 In the message box displayed, click [OK].

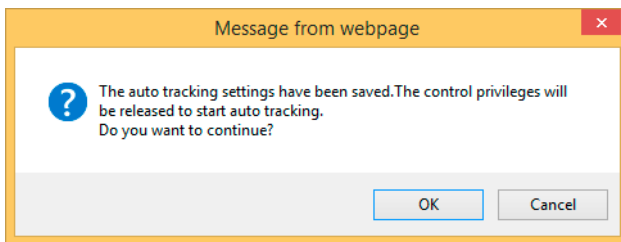

If you keep control privileges, the camera does not automatically track.

For the camera to automatically track moving objects, it is necessary to release control privileges.

Detection Status for Auto Tracking

All moving objects detected are displayed with profile lines.

If a moving object is smaller than [Object Size (%)], its profile lines are white.

If the moving object is larger than [Object Size (%)], its profile lines take on the same color as the detection area, indicating that “detected” mode has been triggered.

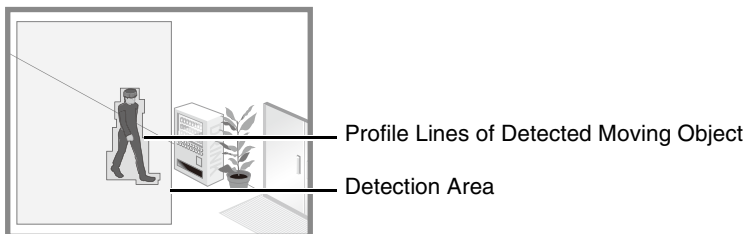

In “detected” mode, auto tracking starts and a polygon frame appears on the target object.

The camera will pan, tilt or zoom during auto tracking so the target object always appears at the center of the screen.

When [Enable auto zoom during tracking] is selected, the camera zooms in on the target and auto tracks.

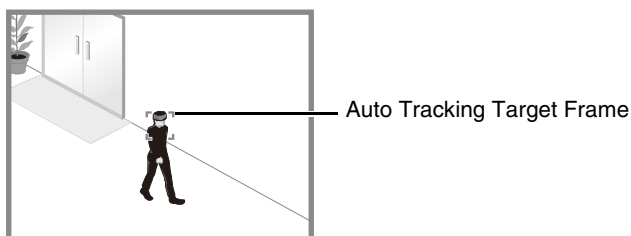

Auto tracking prioritizes tracking the first detected moving object. While auto tracking, other moving objects will not be detected even if they satisfy [Tracking Start Conditions].

Important

- When setting the Auto Tracking Function, it is recommended that you test the auto tracking, to confirm that object will continue to be tracked.
- Moving objects are not individually recognized during auto tracking. Thus when two objects pass each other, or there are multiple moving objects, proper tracking of the object may not be possible.
- If there are multiple moving objects, large objects closest to the center of the screen are prioritized and will continue to be tracked.
- The privacy mask areas are also part of the auto tracking detection area.
- The camera will not track the subject while video is being displayed on the Setting Page, or while camera control privileges are obtained using the camera viewer, etc. To allow automatic tracking with the camera, you must release the camera control privileges.
- While auto tracking, preset tours will not start.
- Auto tracking beyond view restrictions is not possible.

Note

The detection status of auto tracking can also be checked in the [Event and Input/Output] menu of the Camera Viewer (P. 83).

Auto Tracking Termination

Auto tracking will be terminated in the following cases.

- The Camera Viewer, etc. obtained camera control privileges or the video is displayed on the Setting Page.
- The camera moved to a preset position due to the triggering of a volume detection event or an external input device.
R13 R11
- Capture of a panorama image has started.
- You executed [Maintenance] > [General] > [Tool] > [Refresh Drive System]. R13 R11
- The configured auto [Tracking Duration] time has elapsed.
- Tracking cannot continue because sight of the moving object was lost (examples: movement of target object was lost, target object is lost in shadow of another object, target object falls below the sizes possible for tracking, target object moves outside the possible tracking area).
- The [Intelligent Function] has restarted.

When auto tracking is terminated, a tracking OFF event is triggered and the camera returns to the initial camera position (when [Specify the initial camera position] has been selected). If camera control privileges were revoked, the camera will move after camera control privileges are released.

Auto tracking detection resumes after the camera moves back to the original position.

Disabling Auto Tracking

You can disable Auto Tracking by selecting [Video Detection] (P. 175) in [Operation Mode] for the Intelligent Function.

Displaying Settings for Detection Areas and Detection Results (Display Options)

Select whether to display the detection area and detection results in the video display area.

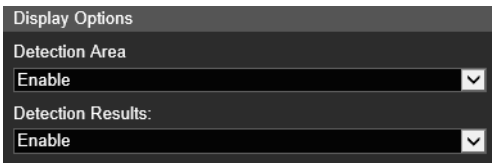

You can select [Enable]/[Disable] for both [Detection Area] and [Detection Results].
[Detection Area] can only be displayed when you have obtained camera control privileges.

[Event] > [Intelligent Function] - Shared Operations -

This explains functions common to both video detection and auto tracking.

Configuring Operations for “Detected” ([Event] Tab)

Set operations to be performed upon detection of changes in a subject.

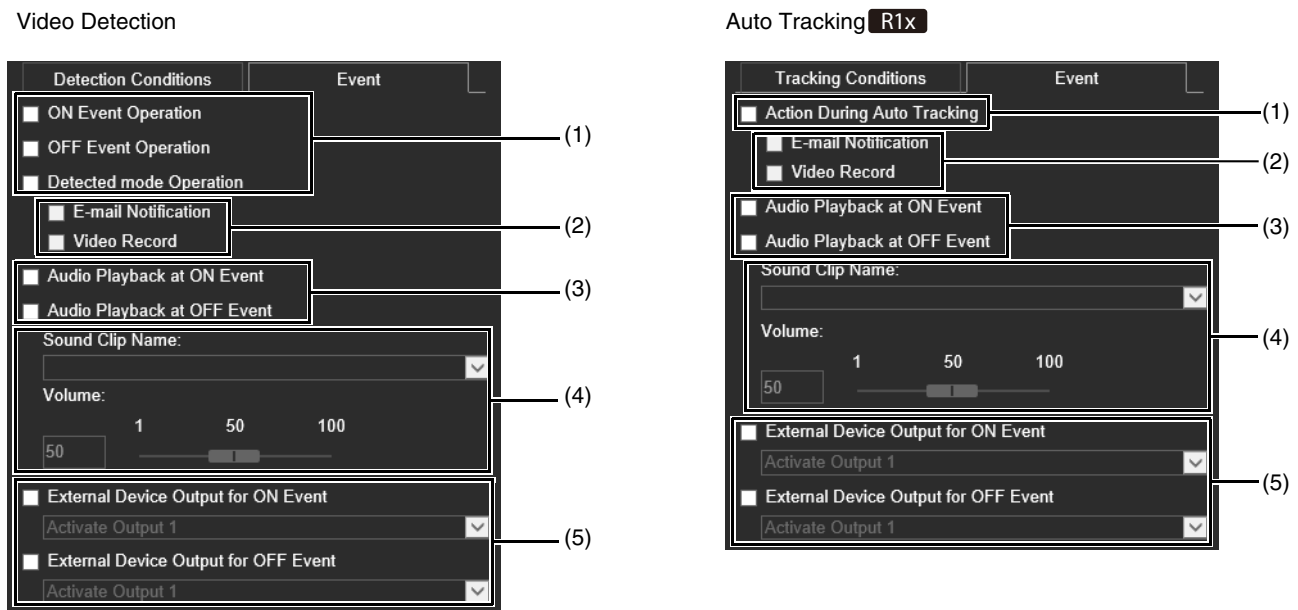

(1) Specify Operation Timing (Multiple Selections Possible)

[ON Event Operation]

When selected, the operations set in (2) are performed when the mode becomes “detected”.

[OFF Event Operation]

When selected, the operations set in (2) are performed when “detected” mode ends.

[Detected mode Operation]

When selected, the operations set in (2) are performed while “detected” mode is active.

[Action During Auto Tracking] **R1x**

When selected, the operations set in (2) are performed while the moving object is automatically tracked.

(2) Specify Event Operation (Multiple Selections Possible)

[E-mail Notification]

When selected, e-mail notification is sent according to the timing set in (1). [Video Record] > [E-mail Notification] on the Setting Page must be set in advance (P. 162).

[Video Record]

When selected, video recording begins according to the timing specified in (1). [Video Record] > [Upload] (P. 158) or [Memory Card] > [Video Record Setting] (P. 217) on the Setting Page must be set in advance.

(3) Specify Audio Playback Timing **R13 R11 M50 H65x M641 H761 H751 M741**

[Audio Playback at ON Event]

When selected, the sound clip specified in (4) is played back when the mode becomes “detected”.

[Audio Playback at OFF Event]

When selected, the sound clip specified in (4) is played back when “detected” mode ends.

(4) Sound Clip Settings **R13 R11 M50 H65x M641 H761 H751 M741**

[Sound Clip Name]

Select the sound clip to be played back. You must register the sound clip with Sound Clip Upload 1 to 3 (P. 150) in [Video and Audio] > [Audio] on the Setting Page in advance.

[Volume]

Set the volume for the sound clip.

(5) **External Device Output Operations** R13 R11 M50 H65x M641 H761 H751 M741

[External Device Output for ON Event]

Select this to start or pause output to an external device when the mode becomes “detected”, and to select the output destination (output 1 or 2) and operation (active or inactive).

[External Device Output for OFF Event]

Select this to start or pause output to an external device when “detected” mode ends, and to select the output destination (output 1 or 2) and operation (active or inactive).

Restarting Intelligent Function

If the background video has changed while you were specifying settings or detection results are not as specified, restart the Intelligent Function.

- 1** If you have not yet obtained the camera control privileges, click the [Obtain/Release Camera Control Privileges] button and obtain the control privileges.
- 2** Click [Restart intelligent function].

Restart intelligent function



Important

It takes several tens of seconds for the Intelligent Function to restart. No detection is performed while restarting.

[Event] > [Switch Day/Night] Executing Presets When Switching Day/Night Mode

When events trigger the switching of Day/Night Mode, presets registered in advance can be executed, such as changing the camera angle or video quality settings.

Switch Day/Night		Apply	Clear
Day/Night Mode Switching			
ⓘ Preset when Switching to Day Mode	None		
ⓘ Preset when Switching to Night Mode	None		

The following settings can be configured here.

- Day/Night Mode Switching

Day/Night Mode Switching

[Preset when Switching to Day Mode]

Executes the preset when switched to Day Mode.

[Preset when Switching to Night Mode]

Executes the preset when switched to Night Mode.



Important

When the user has camera control privileges, the presets for [Preset when Switching to Day mode] and [Preset when Switching to Night Mode] will not run.



Note

- It is necessary to set presets beforehand with [Camera] > [Preset] (P. 131).
- You can set the timing for event-triggered Day/Night Mode switching in [Day/Night Mode Switching] in [External Device Input] **R13** **R11** **M50** **H65x** **M641** **H761** **H751** **M741** (P. 164) or [Timer] (P. 169).

[Event] > [Linked Event] Using Event Combinations

R13 R11 M50 H65x M641 H761 H751 M741

By linking two types of events, a single event is triggered. Select AND/OR for the event linking method. You can set the operations to perform, such as recording video or sending e-mail notifications, when a linked event is triggered.

Linked Event	
Linked Event 1	
Linked Event	Enable
Event Linking Method	AND
Event Order	None
Event Gap (seconds)	2
Event 1	
Event Type	External Device Input
External Device Input	Input 1
External Device Input Status	Active
Event 2	
Event Type	Intelligent Function
Intelligent Function	Setting 1
Intelligent Function Status	ON

The following settings can be configured here.

- Linked Event 1 to 4
- Event 1, 2
- Operation

Operation	
ON Event Operation	Enable
OFF Event Operation	Disable
Ongoing ON Event Operation	Disable
Video Record	Disable
E-mail Notification	Disable
External Device Output for ON Event	Disable
External Device Output for OFF Event	Disable
Audio Playback at ON Event	Enable
Audio Playback at OFF Event	Disable
Sound Clip	Sample
Volume	50

Note

You can check the linked event status on the [Event and Input/Output] menu of the Camera Viewer (P. 83).

Linked Event 1 to 4

You can register up to four linked events.

You can link the following events: [Volume Detection], [Scream Detection], [External Device Input], [Timer] and [Intelligent Function].

[Linked Event]

Select whether to use a linked event.

[Event Linking Method]

Select the event linking conditions.

[AND]: A new linked event is triggered if both event types selected with [Event 1] and [Event 2] are triggered. Set [Event Order] and [Event Gap] for this.

[OR]: A new linked event is triggered if either event type selected with [Event 1] or [Event 2] is triggered.

[Event Order]

You can select the order two events must be triggered when [Event Linking Method] is set to [AND].

If set to [None], the order will not be considered.

[Event Gap (seconds)]

Enter the interval between two events that must be triggered when [Event Linking Method] is set to [AND].

A new linked event is triggered if the second event triggers within the specified interval after the first event was triggered.

Event 1, 2

Specify the two events to be linked. The settings are the same for both.

[Event Type]

Select the event type for linking.

[Volume Detection]/[Scream Detection]

Select whether an ON event or OFF event triggers a linked event in [Volume Detection Status]/[Scream Detection Status].

[External Device Input]

Select External Device Input 1 or 2 in [External Device Input], and then select an active event or inactive event to trigger a linked event in [External Device Input Status].

[Timer]

Select the timer event number to use in [Timer].

[Intelligent Function]

Select the Intelligent Function detection setting number (P. 178) to use in [Intelligent Function], then select whether an ON event or OFF event triggers a linked event in [Intelligent Function Status].

 **Note**

You cannot set the same event type for [Event 1] and [Event 2]. However, a combination of [Input 1] and [Input 2] can be specified for [External Device Input] and a combination of [Timer 1] to [Timer 4] can be set for [Timer].

■ Operation

Set the operations to be performed when linked events are triggered.

[ON Event Operation]

If [Enable] is set, [Preset] **R13 R11 M50 H761**, [Video Record] and [E-mail Notification] will be executed according to their settings when a linked event is triggered (ON event).

[OFF Event Operation]

If [Enable] is set, [Preset] **R13 R11 M50 H761**, [Video Record] and [E-mail Notification] will be executed according to their settings when a linked event is completed (OFF event).

[Ongoing ON Event Operation]

Select the operations to be performed during an ON event.

If [Enable] is selected, [Video Record] and [E-mail Notification] will be executed according to their settings during the linked event.

[Preset] **R13 R11 M50 H761**

If you specify a preset, the camera angle will automatically move to the preset location when a linked event is triggered.

It is necessary to set presets beforehand with [Camera] > [Preset] (P. 131).

**Note **R13 R11 M50 H761****

[Preset] cannot be configured when [Intelligent Function] is included in [Event Type].

[Video Record]

Select whether to record video depending on the linked event.

If you select [Enable] and a linked event is triggered, video will be transmitted to the recording destination specified in [Video Record] > [Upload] > [Video Record Action] (P. 158).

[E-mail Notification]

Select whether to send an e-mail notification depending on the linked event.

If you select [Enable] and a linked event is triggered, an e-mail notification will be sent.

To use e-mail notification, you must set [Video Record] > [E-mail Notification] (P. 162) beforehand.

[External Device Output for ON Event]

Select the states of external device output (1 or 2) when an ON event is triggered.

[External Device Output for OFF Event]

Select the states of external device output (1 or 2) when an OFF event is triggered.

[Audio Playback at ON Event]

If you select [Enable], the sound clip specified in [Sound Clip] will play back when a linked event is triggered.

[Audio Playback at OFF Event]

If you select [Enable], the sound clip specified in [Sound Clip] will play back when a linked event completes.

Note

[Audio Playback at ON Event] and [Audio Playback at OFF Event] can only be set when [External Device Input] and [Intelligent Function] is selected as [Event Type] in [Event 1] and [Event 2].

[Sound Clip]

Select the sound clip when [Audio Playback at ON Event] or [Audio Playback at OFF Event] has been set to [Enable]. You must upload the sound clip 1 to 3 with [Video and Audio] > [Audio] (P. 150) beforehand.

[Volume]

Enter the volume for the sound clip.

Linked Event Operation Examples

This shows linked event status examples according to the ON/OFF combinations for Event 1 and Event 2. In the examples below, [Event Gap] is four seconds and each cell in the graphs below represents one second.

[Event Linking Method] Set to [OR]

Only One Event ON

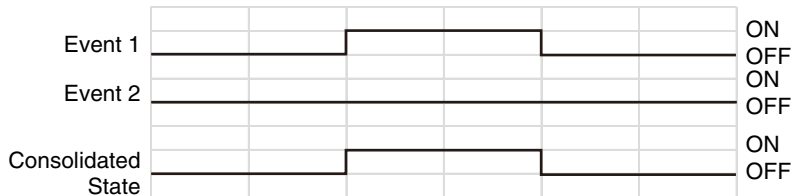

Both Events ON

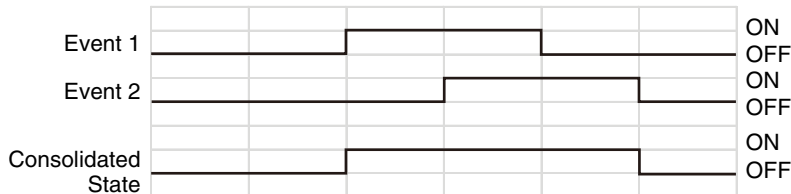

[Event Linking Method] is Set to [AND], [Event Order] is Specified

This shows examples when [Event Order] is set to [Event 1 -> 2].

When [Event Order] is set to [None] and [Event Linking Method] is set to [AND], linked events will be as in the examples, even if Event 1 and Event 2 are switched.

When Events Occur in Order 1 -> 2

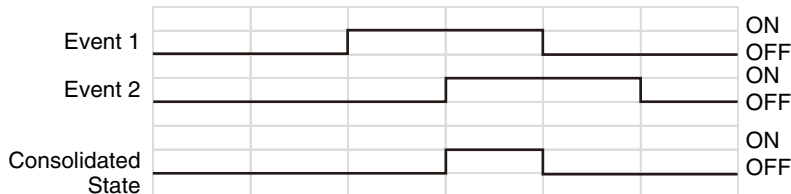

When Events Occur in Order 2-> 1 -> 2

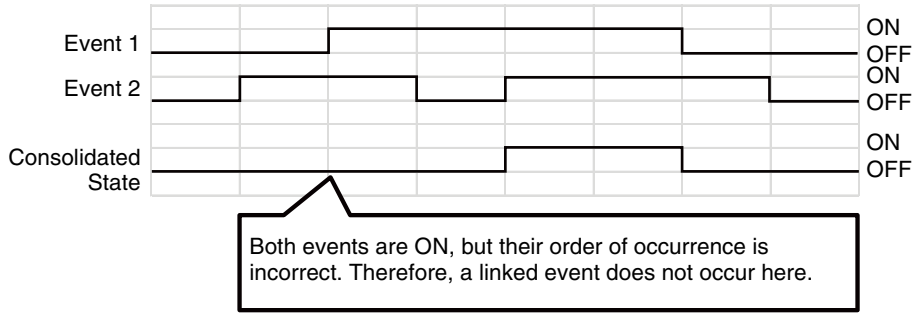

Event 2 Triggered but Event Gap Setting ([4] sec.) Exceeded

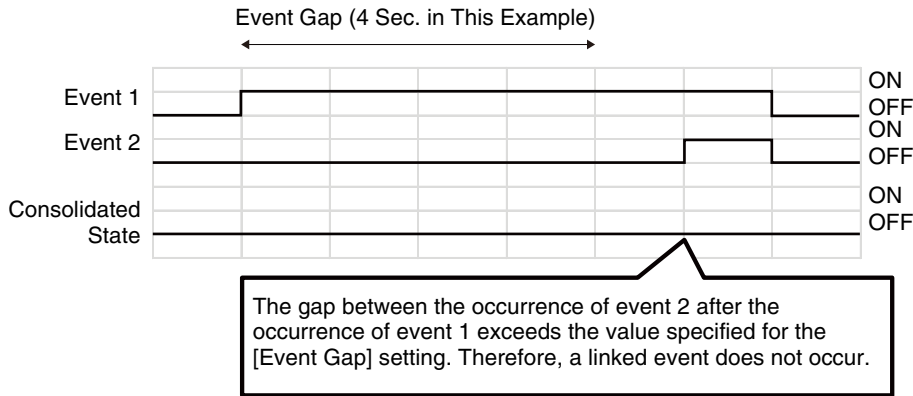

Each Status of Event 1 Set to [OFF], ON States Do Not Coincide

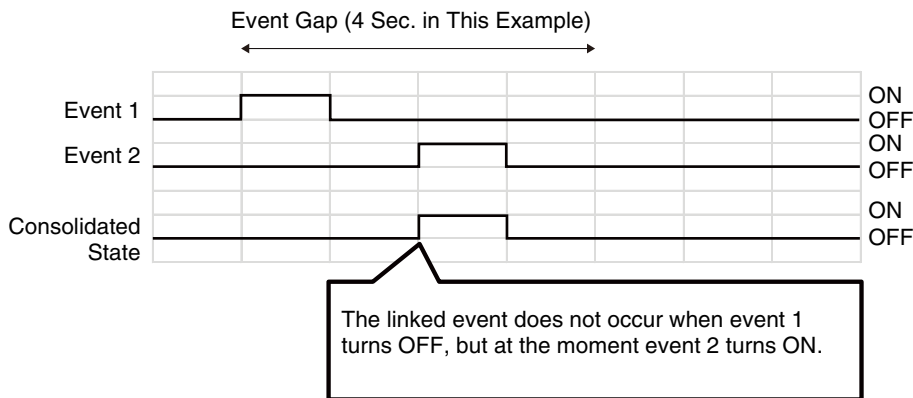

One Event Switches Between ON/OFF

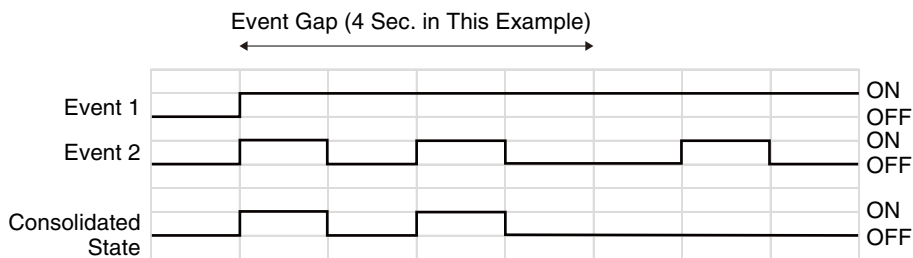

[Security] > [Host Access Restrictions] Setting Access Restrictions

Separate access control from IPv4 and IPv6 addresses can be set.

The screenshot shows the 'IPv4 Host Access Restrictions' configuration page. It has a dark theme. At the top, there are 'Apply' and 'Clear' buttons. Below that, there are two main sections: 'Apply Host Access Restrictions' and 'Default Policy'. 'Apply Host Access Restrictions' is set to 'Enable'. 'Default Policy' is set to 'Authorize Access'. Below these are 20 rows, each with a number (01-20), a text input field, a slash, another text input field, and a 'Yes' dropdown menu. The section below is labeled 'Network Address / Subnet'.

The following settings can be configured here.

- IPv4 Host Access Restrictions
- IPv6 Host Access Restrictions

The screenshot shows the 'IPv6 Host Access Restrictions' configuration page. It has a dark theme. At the top, there are 'Apply' and 'Clear' buttons. Below that, there are two main sections: 'Apply Host Access Restrictions' and 'Default Policy'. 'Apply Host Access Restrictions' is set to 'Enable'. 'Default Policy' is set to 'Authorize Access'. Below these are 20 rows, each with a number (01-20), a text input field, a slash, another text input field, and a 'Yes' dropdown menu. The section below is labeled 'Prefix / Prefix Length'.

Important

- To prohibit access via a proxy server in HTTP connection, a proxy server address must be set.
- If host access restriction is set mistakenly, access to the Setting Pages themselves may be prohibited, in which case restoring the factory default settings will become the only means of recovery.

Note

If the same address is duplicated, the address policy that is displayed highest on the list will be applied.

IPv4 Host Access Restrictions

Specify the hosts from which IPv4 access is permitted and prohibited.

[Apply Host Access Restrictions]

Select whether to use IPv4 host access restrictions.

[Default Policy]

Select whether to allow or block access from IPv4 addresses that have not been specified in [Network Address / Subnet].

[Network Address / Subnet]

Enter IPv4 addresses into the list and select [Yes] or [No] for access for each address.

You can specify the subnet to set access restrictions by network or host.

If set to [No], access to all ports is blocked.

IPv6 Host Access Restrictions

Specify the hosts from which IPv6 access is permitted and prohibited.

[Apply Host Access Restrictions]

Select whether to use IPv6 host access restrictions.

[Default Policy]

Select whether to allow or block access from IPv6 addresses that have not been specified in [Prefix / Prefix Length].

[Prefix / Prefix Length]

Enter IPv6 addresses (prefixes) into the list and select [Yes] or [No] for access for each address.

You can specify the prefix length to set access restriction by network or host.

If set to [No], access to all ports is blocked.

[Security] > [SSL/TLS] Setting HTTP Communication Encryption

Certificate creation and management, and encrypted communication settings.

The screenshot shows the 'SSL/TLS' configuration page. At the top, there are buttons for 'Reboot', 'Apply', and 'Clear'. Below this is the 'Certificates' section. It includes a 'Create Self-Signed Certificate' button with an 'Exec' button next to it. The 'Certificate Status' is shown as 'Not Installed'. Below this are several input fields: 'Country (C)' (2 characters), 'State/Province (ST)' (Up to 128 characters), 'Locality (L)' (Up to 128 characters), 'Organization (O)' (Up to 64 characters), 'Organizational Unit (OU)' (Up to 64 characters), 'Common Name (CN)' (Up to 64 characters), 'Validity Period Start Date' (yyyy/mm/dd), and 'Validity Period End Date' (yyyy/mm/dd).

The following settings can be configured here.

- Certificates
- Certificate Management
- Encrypted Communications

The screenshot shows the 'Certificate Management' section with several actions: 'Generate Certificate Signing Request' (Exec), 'Display Certificate Signing Request' (Exec), 'Install Server Certificate' (Browse... Exec), 'Install Intermediate Certificate' (Browse... Exec), 'Delete Server Certificate' (Exec), 'Delete Intermediate Certificate' (Exec), 'Display Server Certificate Details' (Exec), 'Display Self CA Certificate' (Exec), 'Backup' (Exec), and 'Restore' (Browse... Exec). Below this is the 'Encrypted Communications' section, which has a dropdown menu for 'HTTPS Connection Policy' currently set to 'HTTP'.

Certificates

Create an SSL/TLS certificate.

Important

Use a self-signed certificate when complete security does not need to be ensured, such as through operation tests. For system operation, it is recommended that you acquire and install a certificate issued by a CA.

[Create Self-Signed Certificate]

Enter the following items, click [Apply], and click [Exec] to create a self-signed certificate. Follow the displayed message and reboot. The certificate created will take effect after rebooting.

Note

Creating a certificate takes time, so it is recommended that you stop video transmission and upload processes.

[Certificate Status]

If no certificate is installed, [Not Installed] will be displayed. If a certificate is installed, the validity period for the certificate will be displayed.

[Country (C)]

Enter the ISO3166-1 alpha-2 country code.

[State/Province (ST)], [Locality (L)], [Organization (O)], [Organizational Unit (OU)], [Common Name (CN)]

Enter state/province name, locality, organization name, organizational unit and common name in alphanumeric characters (spaces or printable characters).

Enter an FQDN format host name, etc. to set the common name (required).

[Validity Period Start Date], [Validity Period End Date]

Set the validity period of the certificate to be created (required when creating a self-signed certificate).

Certificate Management

Manage the SSL/TLS certificate.

[Generate Certificate Signing Request]

Click [Exec] to create a server private key and generate a certificate signing request. Once processed, the certificate signing request will be displayed in a separate window.

Note

Generating a certificate signing request takes time, so it is recommended that you stop video transmission and upload processes.

[Display Certificate Signing Request]

Click [Exec] to view the details of the certificate signing request.

[Install Server Certificate]

Perform this operation to install a server certificate. Specify the certificate file to be installed using [Browse] and click [Exec]. The certificate installed will take effect after rebooting.

[Install Intermediate Certificate]

Perform this operation to install an intermediate certificate. Specify the certificate file to be installed using [Browse] and click [Exec]. The certificate installed will take effect after rebooting.

Note

To install an intermediate certificate and a cross root certificate, use a text editor or similar software to place them in the same file and install them as an intermediate certificate.

[Delete Server Certificate]

Click [Exec] to delete the server certificate. However, if SSL/TLS communications are enabled, the certificate cannot be deleted. Set [HTTPS Connection Policy] to [HTTP] before deleting a certificate. The deletion will take effect after rebooting.

[Delete Intermediate Certificate]

Click [Exec] to delete the intermediate certificate along with the cross root certificate. However, if SSL/TLS communications are enabled, the certificate cannot be deleted. Set [HTTPS Connection Policy] to [HTTP] before deleting a certificate. The deletion will take effect after rebooting.

[Display Server Certificate Details]

Click [Exec] to view the details of the server certificate.

[Display Self CA Certificate]

Used for the purpose of testing SSL/TLS communications, but otherwise not normally used.

[Backup]

Click [Exec] to perform a backup of the certificates and private key. This can only be performed when [HTTPS] or [HTTP and HTTPS] is set for [HTTPS Connection Policy] to perform SSL/TLS communication.

[Restore]

Installs the certificates and private key from backup. Click [Browse] to specify the backup file, then click [Exec]. This can only be performed when [HTTPS] or [HTTP and HTTPS] is set for [HTTPS Connection Policy] to perform SSL/TLS communication. The restored certificate will take effect after rebooting.

Encrypted Communications

Set encrypted communications.

[HTTPS Connection Policy]

Set SSL/TLS communication with HTTPS connections. Select [HTTP] if you do not want to perform SSL/TLS communication. Select [HTTPS] or [HTTP and HTTPS] if you want to perform SSL/TLS communication. Connections using SSL/TLS are enabled after rebooting.

If you select [HTTPS], HTTP access is also redirected to HTTPS to perform SSL/TLS communication.

Important

- Even if you set SSL/TLS communication here, SSL/TLS communication is not performed unless you install a certificate.
- Video distribution performance decreases when performing SSL/TLS communication. If you set [HTTPS], you cannot connect with the RM.

Note

- It may take a few minutes to generate an SSL/TLS key.
- Depending on the type of the certificate being installed on the camera, a dialog box may be displayed indicating that the web browser has accepted the certificate and a connection can be made. If the dialog box is not displayed, register the CA certificate in the web browser.

[Security] > [802.1X] Network Port Authentication Settings

Settings for 802.1X authentication and authentication status display, and for certificate management.

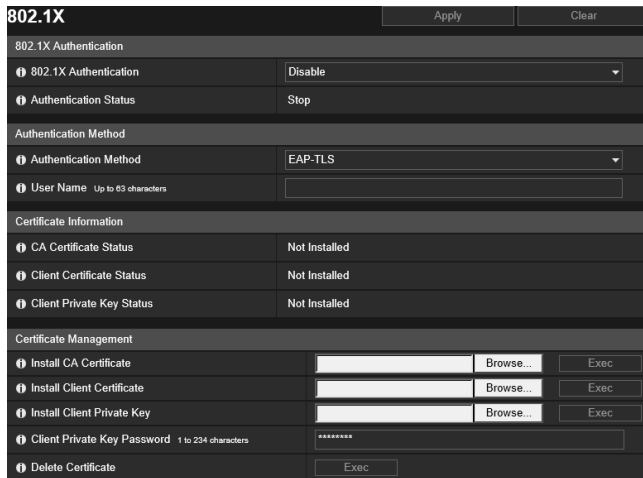

The following settings can be configured here.

- 802.1X Authentication
- Authentication Method
- Certificate Information
- Certificate Management

802.1X Authentication

Display the 802.1X authentication enable/disable control and status.

[802.1X Authentication]

Select this to enable or disable 802.1X authentication.

[Authentication Status]

Display the status of 802.1X authentication. There are three types of status: [Authenticated], [Unauthenticated], and [Stop].

Authentication Method

Set the authentication method used for 802.1X authentication.

[Authentication Method]

Select [EAP-MD5], [EAP-TLS], [EAP-TTLS], or [EAP-PEAP] as the authentication method to use for 802.1X authentication.

[User Name]

Enter the user name used for authentication.

[Password]

Enter the required password for authentication.

This is displayed only when [Authentication Method] is set to [EAP-MD5], [EAP-TTLS], or [EAP-PEAP].

■ Certificate Information

This is displayed only when [Authentication Method] is set to [EAP-TLS], [EAP-TTLS], or [EAP-PEAP].

[CA Certificate Status]

If no CA certificate is installed, [Not Installed] is displayed. If a CA certificate is installed, the validity period of the certificate is displayed.

[Client Certificate Status]

If no client certificate is installed, [Not Installed] is displayed. If a client certificate is installed, the validity period of the certificate is displayed.

This is displayed only when [Authentication Method] is set to [EAP-TLS].

[Client Private Key Status]

If no client private key is installed, [Not Installed] is displayed. If a client private key is installed, [Installed] is displayed.

This is displayed only when [Authentication Method] is set to [EAP-TLS].

■ Certificate Management

This is displayed only when [Authentication Method] is set to [EAP-TLS], [EAP-TTLS], or [EAP-PEAP].



Important

- If any CA certificates, client certificates, and client private keys already exist when installing certificates, they are discarded and new versions are installed.
- An error occurs if the format of the certificate or private key to be installed is incorrect.
- Client certificates and client private keys are checked as a pair when installing, and an error occurs if they do not match.
- The certificate and private key used for 802.1X authentication must be installed as separate items, irrespective of the installation status of certificates for SSL/TLS.

[Install CA Certificate]

Installs a CA certificate.

Specify the certificate file to be installed using [Browse] and click [Exec].

[Install Client Certificate]

Installs a client certificate.

Specify the certificate file to be installed using [Browse] and click [Exec].

This is displayed only when [Authentication Method] is set to [EAP-TLS].

[Install Client Private Key]

Installs a client private key.

Specify the private key file to be installed using [Browse] and click [Exec].

This is displayed only when [Authentication Method] is set to [EAP-TLS].

[Client Private Key Password]

Enter the password for the client private key.

Required when a password has been configured for the private key.

This is displayed only when [Authentication Method] is set to [EAP-TLS].

[Delete Certificate]

Deletes all installed CA certificates, client certificates, and client private keys.

Only "CA Certificate" is displayed when [Authentication Method] is set to [EAP-TTLS] or [EAP-PEAP], but any installed client certificates and client private keys are also deleted.

[Security] > [IPsec] Setting IPsec

Settings for using IPsec.

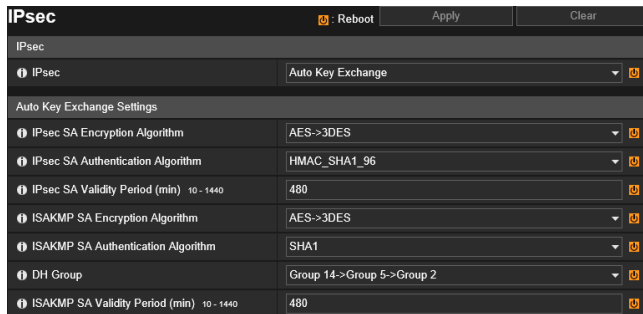

The following settings can be configured here.

- IPsec
- Auto Key Exchange Settings
- IPsec Set 1 to 5

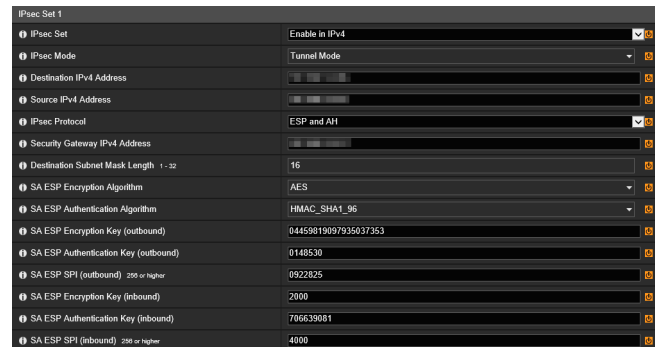

Important

- To run this camera with IPsec, the communicating devices and network must be set beforehand. Contact your system administrator for these settings.
- When connecting with IPsec, set the camera IP address manually.
For IPv4 addresses, use addresses with [IPv4 Address Settings Method] set to [Manual] in [Basic] > [Network] > [IPv4].
For IPv6 addresses, use addresses set with [IPv6 Address (Manual)] in [Basic] > [Network] > [IPv6].
- If the IPsec setting is changed and the camera may become inaccessible from the active web browser, a confirmation dialog box will be displayed. Click [OK] to apply the new settings.
If you reboot the camera and cannot connect to the camera from the web browser, any available URI for connecting to the camera will be displayed in a message.
If you cannot connect to the camera through the displayed URI, contact your system administrator.

Note

If IPsec is used, video transmission performance drops.

IPsec

[IPsec]

Select the key exchange method when using IPsec.

Auto Key Exchange Settings

[IPsec SA Encryption Algorithm]

Select the IPsec SA encryption algorithm.

The specified algorithm will be checked for an applicable encryption algorithm starting from the left.

[IPsec SA Authentication Algorithm]

Select the IPsec SA authentication algorithm.

The specified algorithm will be checked for an applicable authentication algorithm starting from the left.

[IPsec SA Validity Period (min)]

Enter the duration of validity for IPsec SA.

[ISAKMP SA Encryption Algorithm]

Select the SA encryption algorithm for use with auto key exchange protocol IKE.

[ISAKMP SA Authentication Algorithm]

Select the SA authentication algorithm for use with auto key exchange protocol IKE.

[DH Group]

Select the key generation information that will be used in the DH algorithm for key exchange via auto key exchange protocol IKE. The higher the group number, the stronger security will be.

[ISAKMP SA Validity Period (min)]

Enter the duration of validity for ISAKMP SA.

IPsec Set 1 to 5

IP security can be specified through auto key exchange or manual setting with up to five communicating devices.

■ Auto Key Exchange



Important

If the camera is rebooted during auto key exchange communication, a connection error may result after rebooting. If this occurs, connect again.



Note

If auto key exchange is used, it will take approximately 5 to 10 seconds before communication with the camera starts.

[IPsec Set]

Select which IPsec sets the camera will use; IPv4, IPv6, or neither.

[IPsec Mode]

Select the IPsec mode.

[Destination IPv4 Address], [Destination IPv6 Address]

Enter the IP address of the connection destination.

[Source IPv4 Address], [Source IPv6 Address]

Enter the IP address of the source.

[IPsec Protocol]

Select the IPsec protocol.

If you select [ESP], enter only the setting items relating to ESP.

If you select [AH], enter only the setting items relating to AH.

If you select [ESP and AH], enter all setting items.

[Security Gateway IPv4 Address], [Security Gateway IPv6 Address]

Enter the IP address of the security gateway if [IPsec Mode] is set to [Tunnel Mode].

[Destination Subnet Mask Length], [Destination Prefix Length]

Enter the subnet mask (IPv4) or prefix length (IPv6) when [IPsec Mode] is set to [Tunnel Mode].

[IKE Pre-Shared Key]

Enter the pre-shared key for IKE (auto key exchange).

■ Manual

[IPsec Set]

Select which IPsec sets the camera will use; IPv4, IPv6, or neither.

[IPsec Mode]

Select the IPsec mode.

[Destination IPv4 Address], [Destination IPv6 Address]

Enter the IP address of the connection destination.

[Source IPv4 Address], [Source IPv6 Address]

Enter the IP address of the source.

[IPsec Protocol]

Select the IPsec protocol.

If you select [ESP], enter only the setting items relating to ESP.

If you select [AH], enter only the setting items relating to AH.

If you select [ESP and AH], enter all setting items.

[Security Gateway IPv4 Address], [Security Gateway IPv6 Address]

Enter the IP address of the security gateway if [IPsec Mode] is set to [Tunnel Mode].

[Destination Subnet Mask Length], [Destination Prefix Length]

Enter the subnet mask (IPv4) or prefix length (IPv6) when [IPsec Mode] is set to [Tunnel Mode].

If the Setting in [IPsec Protocol] Includes “ESP”**[SA ESP Encryption Algorithm]**

Set the ESP encryption algorithm to suit the encryption algorithm supported by the device to connect to.

Normally [AES] or [3DES] is recommended.

[SA ESP Authentication Algorithm]

Set the ESP authentication algorithm to suit the authentication algorithm supported by the device to connect to.

If [ESP] is used alone, [No Authentication] cannot be selected.

[SA ESP Encryption Key (outbound)]

Enter the SA encryption key for outbound.

If [AES], [3DES] or [DES] was selected in [SA ESP Encryption Algorithm], set a 128-bit, 192-bit or 64-bit hexadecimal number, respectively. This item need not be set if [NULL] was selected.

[SA ESP Authentication Key (outbound)]

Enter the SA authentication key for outbound.

If [HMAC_SHA1_96] or [HMAC_MD5_96] was selected in [SA ESP Authentication Algorithm], set a 160-bit or 128-bit hexadecimal number, respectively. This item need not be set if [No Authentication] was selected.

[SA ESP SPI (outbound)]

Enter the SA SPI value for outbound.

Set a desired value in the range of 256 to 4294967295.

[SA ESP Encryption Key (inbound)]

Enter the SA encryption key for inbound.

If [AES], [3DES] or [DES] was selected in [SA ESP Encryption Algorithm], set a 128-bit, 192-bit or 64-bit hexadecimal number, respectively. This item need not be set if [NULL] was selected.

[SA ESP Authentication Key (inbound)]

Enter the SA authentication key for inbound.

If [HMAC_SHA1_96] or [HMAC_MD5_96] was selected in [SA ESP Authentication Algorithm], set a 160-bit or 128-bit hexadecimal number, respectively. This item need not be set if [No Authentication] was selected.

[SA ESP SPI (inbound)]

Enter the SA SPI value for inbound.

Set a desired value in the range of 256 to 4294967295.

Since this setting is used as an ID for identifying the SA, be careful not to specify an inbound SPI whose value is already used in another ESP's SPI.

If the Setting in [IPsec Protocol] Includes “AH”**[SA AH Authentication Algorithm]**

Set the AH authentication algorithm to suit the authentication algorithm supported by the device to connect to.

[SA AH Authentication Key (outbound)]

Enter the SA authentication key for outbound.

If [HMAC_SHA1_96] or [HMAC_MD5_96] was selected in [SA AH Authentication Algorithm], set a 160-bit or 128-bit hexadecimal number, respectively.

[SA AH SPI (outbound)]

Enter the SA SPI value for outbound.

Set a desired value in the range of 256 to 4294967295.

[SA AH Authentication Key (inbound)]

Enter the SA authentication key for inbound.

If [HMAC_SHA1_96] or [HMAC_MD5_96] was selected in [SA AH Authentication Algorithm], set a 160-bit or 128-bit hexadecimal number, respectively.

[SA AH SPI (inbound)]

Enter the SA SPI value for inbound.

Set a desired value in the range of 256 to 4294967295.

Since this setting is used as an ID for identifying the SA, be careful not to specify an inbound SPI whose value is already used in another AH's SPI.

[Memory Card] Memory Card Operations and Information Display

Settings for recording video to a memory card inserted in the camera. You can also see the status of the memory card. [Memory Card] is the same as [Video Record] > [Memory Card]. Settings configured on one [Memory Card] page are also reflected on the other.

Memory Card	
Video Record Settings	
Video Record Action	Upload
Memory Card Operations	
Mount/Unmount	Unmount
Operation Settings	Save Logs and Videos
Video Format	JPEG
Pre-event Buffer (number of frames) 0-100	0
Post-event Buffer (number of frames) 0-100	0
Overwrite videos	Disable
Auto Video Delete	Enable
Days Saved 1-90	30
Delete Time hh:mm	00:00
Recreate Video Management Information	Exec
Format	Exec

The following settings can be configured here.

- Video Record Setting
- Memory Card Operations
- Memory Card Information

Memory Card Information	
Memory Card Recognition	Mounted
Memory Card Operation Status	Operable
Video Management Information Status	Normal
Video Saving	Can Save
Memory Card Capacity	62848900KB (59.9GB)
Used Capacity	6164172KB (5.8GB)

Important

Information recorded to the memory card may be regarded as “personal information”. Take sufficient precautions for handling this information when releasing the camera to third parties for disposal, transfer or repair.

Note

- Memory card videos can be viewed and managed using the Recorded Video Utility. For information on operating the Recorded Video Utility and its downloaded data, please refer to “Recorded Video Utility User Manual”.
- When a large number of files have been recorded onto a memory card, the Recorded Video Utility can take a considerable amount of time to process the video list (the greater the number of files, the longer it will take). Please reduce the number of days saved in [Auto Video Delete], or manually delete unneeded files with the Recorded Video Utility, on a regular basis. The number of files saved on the memory card can greatly be reduced, by using H.264 as the video format, instead of JPEG.
- The following memory cards can be used.
 - SD memory card, SDHC memory card, SDXC memory card **R1x** **M50** **H76x** **H751**
 - microSD memory card, microSDHC memory card, microSDXC memory card **H65x** **M64x**
- For inserting and removing the memory card, please refer to “Installation Guide”.
- If you are using the memory card in the camera for the first time, format the memory card after inserting it into the camera (P. 219).

Video Record Setting

Sets whether to record video from the camera to a memory card or upload it with HTTP or FTP.

These can also be set with [Video Record] > [Upload] (P. 158) and will be reflected in [Video Record Settings] here.

[Video Record Action]

Select [Record to Memory Card] to record to a memory card.

Memory Card Operations

The setting items will change depending on the memory card status (unmounted/mounted).

Important

Be sure to perform the unmount process when turning off the power to the camera or removing the memory card. Failing to unmount first may result in management file problems or the memory card becoming inaccessible.
You can use the Camera Management Tool (P. 22) to batch mount/unmount memory cards from multiple cameras.

The memory card will be automatically mounted when you insert it into the memory card slot. It will also be automatically mounted if it has been inserted in the memory card slot when the camera starts up.

[Mount/Unmount]

Click [Unmount] to unmount the memory card.

Be sure to unmount the memory card when turning off the power to the camera or removing the memory card.

Also click [Mount] with the memory card inserted to mount the memory card.

[Operation Settings]

Select the data to save to the memory card.

When [Save Logs and Videos] has been set, the following data is saved automatically.

- Image files of recording-mode stream that could not be distributed due to a network error
- Video files when HTTP or FTP upload failed
- Video files manually recorded by the user from the Camera Viewer
- Video files recorded by [External Device Input], [Volume Detection] and [Intelligent Function] when an event occurs
- Video files recorded using a timer
- Log
- Video recorded with ONVIF

Note

New files cannot be saved to the memory card if there is no free space. When [Overwrite videos] is set to [Enable], old video can be deleted to save new video (P. 218).

[Video Format]

Select the video format to record to a memory card.

Video is recorded in this format when [Video Record Action] is set to [Record to Memory Card].

Video size and quality of the recorded video follow the settings in [Video] (P. 102).

Important

- For [H.264(1)] or [H.264(2)], the following settings must be configured in [Video] > [H.264(1)] (P. 103), H.264(2) (P. 104).
 - [Bit Rate Control]: [Use bit rate control]
 - [Target Bit Rate (kbps)]: [3072] or less
 - [I Frame Interval (sec)]: [0.5], [1] or [1.5]
- You cannot select a different H.264 format from that in [Video Record] > [Upload] > [General Upload] > [Video Format] (P. 159).

Note

- When set to [JPEG] and an upload error occurs, the frame rate of video recorded in JPEG format is always 1 fps.
- When a network error occurs interrupting the transmission of recording-mode stream video, video is saved in the JPEG format regardless of the [Video Format] setting (the frame rate is fixed at 1 fps).

[Pre-event Buffer (number of frames)] (JPEG)/ [Pre-event Buffer (sec)] (H.264)

Enter the number of frames or seconds of video to be buffered before the event.

Enter the maximum number of frames for [JPEG] or the maximum number of seconds for [H.264(1)] or [H.264(2)] in [Video Format].

Depending on conditions, however, saving the set number of frames or seconds may not be possible.

[Post-event Buffer (number of frames)] (JPEG)/ [Post-event Buffer (sec)] (H.264)

Enter the number of frames or seconds of video to be buffered after the event.

Enter the maximum number of frames for [JPEG] or the maximum number of seconds for [H.264(1)] or [H.264(2)] in [Video Format].

Depending on conditions, however, saving the set number of frames or seconds may not be possible.

[Overwrite videos]

Select whether to allow overwriting data when the available space on the memory card becomes too low while recording video to a memory card due to an event being triggered.

If you select [Enable], videos recorded due to an event, timer or ONVIF will be overwritten starting from the oldest file.

If you select [Disable], use the Recorded Video Utility to delete unnecessary videos. For information on the procedure, please refer to “Recorded Video Utility User Manual.”

[Auto Video Delete]

Select to automatically delete video from the memory card that has exceeded the [Days Saved] setting. If you select [Enable], set [Days Saved] and [Delete Time].

[Days Saved]

Enter the number of days for which video recorded to the memory card should be saved.

[Delete Time]

Enter the time to delete video that has exceeded the [Days Saved] setting.

[Recreate Video Management Information]

If you click [Exec], the management information file for recorded video will be recreated on the memory card. The memory card cannot be accessed during this process. It is also recommended that users not upload or stream video from the camera.

When recreating video management information files, the more files you recreate, the longer the process will take; it may require several hours.

[Format]

Click [Exec] to format the memory card. Formatting erases all files and directories on the memory card.



Note

Formatting is performed using a quick format.

Memory Card Information

Displays the status of the memory card inserted in the camera and information about card capacity.

[Memory Card Recognition]

Displays the current status of the memory card.

[Memory Card Operation Status]

Displays the operation status of the memory card.

[Operable]: All operations are possible.

[Recreating video management information]: This status indicates that video management information is being recreated. Other operations cannot be performed.

[Deleting videos]: This status indicates that videos are being deleted. Other operations cannot be performed.

[Video Management Information Status]

Displays the status of the video management information.

[Normal]: This status indicates that video management information is normal.

[Video Management Information Recreation Required]: This status indicates that management files are corrupted or not consistent with saved video files.

It is necessary to click [Exec] in [Recreate Video Management Information] to recreate the management file.

If the management files are not recreated even when [Recreate Video Management Information] is used, [Format] (P. 219) must be used.

[Video Saving]

Displays whether videos can be saved to the memory card.

[Cannot Save] may occur for the following reasons.

- Memory card is not mounted.
- The video management file is corrupted.
- The card is write-protected.
- The memory card is full and [Overwrite videos] is set to [Disable].

[Memory Card Capacity]

Displays the current capacity of the memory card.

[Used Capacity]

Displays the current used capacity of the memory card.

[Maintenance] > [General] Displaying Camera Device Information and Perform Maintenance

Check camera information, such as the firmware version, and perform maintenance on the camera system.

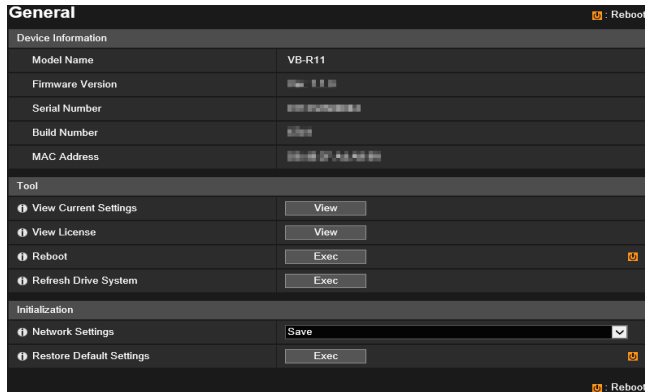

The following settings can be configured here.

- Device Information
- Tool
- Initialization

Device Information

[Model Name], [Firmware Version], [Serial Number], [Build Number] and [MAC Address]

Displays information about the camera.

Note

Please note that the [Model Name] for the VB-H761LVE-H, VB-H751LE-H, and VB-M741LE-H are displayed as VB-H761LVE, VB-H751LE, and VB-M741LE respectively.

Tool

You can configure/reboot the camera and display licenses.

[View Current Settings]

Display a list of current settings for the Setting Page.

[View License]

Display information on the third-party software licenses.

[Reboot]

Reboot the camera.

[Refresh Drive System] **R1X**

When Refresh Drive System is executed, the camera pans twice in both directions horizontally, and then returns to the camera angle prior to execution.

If you repeatedly perform pan/tilt operations for a long time, video or audio problem linked to pan operations may occur. In this case, executing Refresh Drive System may resolve these problems.

Note **R1X**

The following users will be disconnected while refreshing the drive system.

- All users except for administrators
- Users not connected via RTP

Initialization

Initialize the camera.

Caution

- You must not turn off the camera while [Restore Default Settings] is in operation. Turning off the camera at this stage may result in disabling its ability to boot correctly.
- Once [OK] is clicked, you can no longer stop the process of restoring the default settings.

[Network Settings]

If you set this to [Save], the following settings are retained when initializing.

- Administrator Name
- Password
- Network Settings
- Time Zone
- Certificates
- Private Key

If you set this to [Do not save], the above settings are also initialized.

Since the administrator account is also initialized, you will become unable to connect to the camera. Use the Camera Management Tool to configure the initial settings (P. 37).

[Restore Default Settings]

The initial settings are restored according to the selection in [Network Settings] after rebooting.



Note

- It is recommended that you back up each current setting before you click [Exec] in [Restore Default Settings].
- The camera can also be restored to factory default settings using the reset switch. Note, however, that this will reset all camera settings to factory default settings except for date and time (P. 247).

[Maintenance] > [Backup / Restore] Saving/Restoring Camera Settings

You can save/restore all the camera settings.

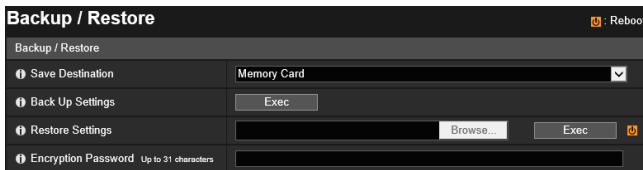

The following settings can be configured here.

- Backup / Restore

Backup / Restore

Configure the settings regarding backup and restoring.

Caution

You must not turn off the camera while [Back Up Settings] or [Restore Settings] are in operation. Turning off the camera at this stage may result in disabling its ability to boot correctly.

[Save Destination]

Select the destination for saving the camera settings when backing up.

[Back Up Settings]

All settings, except date and time, will be backed up. The administrator account, certificates used by SSL/TLS and 802.1X and private key will also be backed up.

[Restore Settings]

Restores all settings, except date and time, from the backup file created with [Back Up Settings].

If [PC] is selected in [Save Destination], click [Browse] to specify the backup file.

The administrator account, IP address, certificates used by SSL/TLS and 802.1X and private key will also be restored.

After restore is completed, the camera will be rebooted.



Important

- Take care when restoring from the backup file of another camera, as problems such as not being able to connect to the camera may occur due to the network address conflicting or the administrator password being overwritten.
- When restoring the settings, do not use a backup file created with a firmware version newer than that of the camera to restore.

[Encryption Password]

Set the password to use when backing up and restoring. This is the password for encrypting the backup data itself.

When restoring from encrypted backup data, enter the password set when backing up.



Note

The settings are not restored if the password set when backing up and the password set when restoring do not match.

[Maintenance] > [Update Firmware] Updating the Camera Firmware

You can update the firmware.



The following settings can be configured here.

- Update Firmware

Device Information

[Model Name] and [Firmware Version]

Displays the information about the connected camera.

Note

Please note that the [Model Name] for the VB-H761LVE-H, VB-H751LE-H, and VB-M741LE-H are displayed as VB-H761LVE, VB-H751LE, and VB-M741LE respectively.

Update Firmware

Configure the settings related to firmware updates.

Caution

You must not turn off the camera while it is performing the [Update Firmware] operation. Turning off the camera at this stage may result in disabling its ability to boot correctly.

[Restore Default Settings]

The initial settings are restored when the firmware is updated.

If you set this to [Restore], the following settings are retained when initializing.

- Administrator Name
- Password
- Network Settings
- Time Zone
- Certificates
- Private Key

[Update Firmware]

Click [Browse], specify a firmware file for update, and click [Exec]. When the confirmation message is displayed, click [OK] to start the firmware update.

The camera is rebooted after the firmware is updated.

[Maintenance] > [Log] Checking/Sending Camera Log Information

You can check the camera operations and connection history, and set log message e-mail transmission.

Log		Apply	Clear
View Logs			
View Logs		View	
Log Notifications			
Use log notifications	Enable		
Notification Level	Error		
Copy E-mail Settings		Exec	
Mail Server Name	Up to 63 characters		
Mail Server Port	1 - 65535	25	
Sender (From)	Up to 63 characters		
Recipient (To)	Up to 63 characters		
Authentication		POP before SMTP	
User Name	Up to 31 characters	username	
Password	Up to 31 characters	*****	
POP Server	Up to 63 characters	popserver	
Subject	Up to 31 characters		
Log Notification Test		Exec	

The following settings can be configured here.

- View Logs
- Log Notifications

View Logs

Display a history of camera operations and connections.

[View Logs]

If you click [View], the log messages saved since the camera was started are displayed.
For details on log messages, please refer to “List of Log Messages” (P. 232).

Log Notifications

Set the mail server and e-mail address to use for log notification.

[Use log notifications]

If you select [Enable], the following setting items for log notification are displayed.

[Notification Level]

Select the log notification level.

For details on levels of log messages, please refer to “Log Messages on the Camera” (P. 232).

[Copy E-mail Settings]

Copies the e-mail settings used in [Video Record] > [E-mail Notification] (P. 162). However, [Password] is not copied.

[Mail Server Name]

Enter the host name or IP address of the SMTP server.

[Mail Server Port]

Enter the port number for the SMTP server (factory default setting is [25]).

[Sender (From)]

Enter the e-mail address of the sender.

[Recipient (To)]

Enter the e-mail address of the recipient.

[Authentication]

Select an authentication method suited to the destination SMTP server.

[User Name], [Password], [POP Server]

Enter the user name and password needed for authentication, and the POP server host name or IP address when e-mail authentication is set to [POP before SMTP].

Enter the user name and password needed for authentication when e-mail authentication is set to [SMTP-AUTH].

[Subject]

Enter the subject of the e-mail in alphanumeric characters.

[Log Notification Test]

Clicking [Exec] initiates an e-mail notification test based on the settings currently entered.

If something other than [None] is selected for [Authentication], click [Exec] before clicking [Apply] after entering the [Password].

Chapter

6

Appendix

This chapter provides supplementary information on camera functions, and explains the measures to take when trouble occurs or a message is displayed during camera use. It also explains how to reset the camera to the factory default setting state.

Modifiers

According to the setting item, you can specify parameters using modifier “%” characters”.

Modifiers	Meaning	Description of character string entered
%n	Reason for capture (number)	0 (test) 1 (External device input 1) 2 (External device input 2) 33 (Timer 1) 34 (Timer 2) 35 (Timer 3) 36 (Timer 4) 145 (Volume detection) 146 (Scream Detection) 160 (Auto Tracking) 161 (Intelligent Function Detection Setting 1) 162 (Intelligent Function Detection Setting 2) 163 (Intelligent Function Detection Setting 3) 164 (Intelligent Function Detection Setting 4) 165 (Intelligent Function Detection Setting 5) 166 (Intelligent Function Detection Setting 6) 167 (Intelligent Function Detection Setting 7) 168 (Intelligent Function Detection Setting 8) 169 (Intelligent Function Detection Setting 9) 170 (Intelligent Function Detection Setting 10) 171 (Intelligent Function Detection Setting 11) 172 (Intelligent Function Detection Setting 12) 173 (Intelligent Function Detection Setting 13) 174 (Intelligent Function Detection Setting 14) 175 (Intelligent Function Detection Setting 15) 201 (Linked Event 1) 202 (Linked Event 2) 203 (Linked Event 3) 204 (Linked Event 4)
%N	Reason for capture (character string)	<External input device name (alphanumeric characters) > Intelligent Function Detection Setting name NULL (blank entry or interval timer test)
%O	Reason for capture (ON/OFF)	OFF ON
%X	Width of image	Number of pixels in horizontal direction
%Y	Height of image	Number of pixels in vertical direction
%C	Camera number	1
%D	Camera Name	Setting for [Camera Name (alphanumeric characters)]
%P	Pan position	R13 R12 -180.00 – 180.00 R11 R10 M50 -179.99 – 180.00 H65x M64x H76x H751 M74x 0
%T	Tilt position	R13 R12 -180.00 – 180.00 R11 R10 M50 -179.99 – 180.00 H65x M64x H76x H751 M74x 0
%Z	Zoom position	0.01 – 300.00
%R	Rotation position	0
%V	Camera server	VB-R13VE / VB-R13 / VB-R12VE / VB-M50B / VB-H652LVE / VB-H651VE / VB-H651V / VB-H761LVE / VB-H760VE / VB-H751LE
%y	Year of capture time	2001 – 2031
%m	Month of capture time	01 – 12
%d	Day of capture time	01 – 31
%w	Day of week of capture time	0 – 6 (Sunday to Saturday)
%H	Hours of capture time	00 – 23
%M	Minutes of capture time	00 – 59
%S	Seconds of capture time	00 – 59
%s	Milliseconds of capture time	000 – 999
%z	Time zone of capture time	-1200 – +1300
%a	Weekday name of capture time	Sun Mon Tue Wed Thu Fri Sat
%b	Month name of capture time	Jan Feb Mar Apr May Jun Jul Aug Sep Oct Nov Dec
%h	Host Name	

Note

- A runtime error will occur if the specified name does not match.
- If this modifier is not defined, “%” will be deleted.

■ Available Modifiers

The modifiers that can be used for each setting item are specified below.

[HTTP Upload] (P. 159)

[Parameter (query string)]

All modifiers can be used.

[FTP Upload] (P. 160)

[Subdirectory Name to Create]

Only the modifiers %y, %m, %d, %w, %H, %h, %n can be used.

[File Name to Create]

Only the modifiers %y, %m, %d, %w, %H, %M, %S, %s, %n can be used.

[E-mail Notification] (P. 162)

[Message Body]

All modifiers can be used.

Troubleshooting

Before contacting the dealer from whom you purchased the product or Canon Customer Service Center, check the following items. If a log message is displayed, check the details of the message and the corresponding countermeasures in the log message list.

Note

For information on troubleshooting for the Camera Management Tool, Recorded Video Utility, and Mobile Camera Viewer, please refer to each individual manual.

Problem	Countermeasures
The camera does not launch.	<ul style="list-style-type: none"> • If you are using a PoE hub, check if the LAN cable is connected correctly. • If you are using an AC adapter (sold separately), check if the AC adapter is connected correctly. • Turn the camera off and on again (please refer to "Installation Guide").
Cannot connect to the camera.	<ul style="list-style-type: none"> • Check if the LAN cable is connected correctly. • Check if the network to which the camera is connected is set up correctly. In particular, check if the IP address, subnet mask and default gateway address are set within the ranges supported by the applicable network. • If you have changed the IP address, the new address will not become effective until the camera is rebooted. • Check if the correct URI (camera IP address) is entered in your web browser (P. 40). • Check whether the connection is from a computer whose access is blocked in [Security] > [Host Access Restrictions] (P. 206) on the Setting Page. • Ask your system administrator whether the authentication method set in [Security] > [802.1X] (P. 211) on the Setting Page and the combination of [User Name], [Password] and certificates match the rules of the network to connect to.
The Camera Viewer will not launch.	<ul style="list-style-type: none"> • If the message "Your web browser is not supported." is displayed, use Internet Explorer 9 or greater, or a version of Chrome that is guaranteed to operate. • If the message "JavaScript is not available or disabled on your web browser." is displayed, click [Network and Internet] > [Internet Options] > [Security] > [Custom level] in [Control Panel], and set [Active scripting] to [Enable]. • To enable authorized users and guest users to use the Camera Viewer, specify the following settings on the Setting Page. <ul style="list-style-type: none"> – Assign [Camera Control] or [Video Distribution] to authorized users/guest users in [Basic] > [User Management] > [User Authority]. – Set [Basic] > [Viewer] > [General] > [Default Page] to [Display Viewer]. – To also enable guest users to use the Camera Viewer, set [Basic] > [Viewer] > [Viewer Settings] > [User Authentication] to [Do not authenticate].
Cannot use some functions of the Camera Viewer.	<ul style="list-style-type: none"> • Follow the procedure in "Adding the Camera IP Address as a Trusted Site" (P. 34) to add this website to [Trusted sites] in the [Security] settings. • If you are using a web browser other than Internet Explorer or if the Canon Network Camera Addon Module is not correctly installed when using Internet Explorer, the following functions cannot be used. <ul style="list-style-type: none"> – Receiving/transmitting audio – Receiving/playing H.264 video
Video is not displayed.	<ul style="list-style-type: none"> • The number of Viewers that can access the camera at the same time is restricted by the setting in [Maximum Number of Clients] in [Server] > [Video Server] (a maximum of 30 can be specified). If this restriction is exceeded, a message is displayed and video is not displayed. • Video can only be displayed by authorized users and guest users if [Video Distribution] privileges are assigned. Ask your administrator to assign [Video Distribution] privileges in [Basic] > [User Management] > [User Authority]. • If the Viewer is opened with Internet Explorer 10 or 11 on a 64-bit operating system, H.264 video may not be able to be received or played if the camera is added to the list of trusted sites and the enhanced protected mode is enabled. In this case, add the camera to the list of trusted sites and disable the protected mode of trusted sites.

Problem	Countermeasures
There is no audio. R13 R11 M50 H65x M641 H761 H751 M741	<ul style="list-style-type: none"> • If there is no audio, check the settings in [Server] > [Audio Server] on the Setting Page as well as the sound and audio device settings for the computer. • If the Camera Viewer is used with administrator privileges, check whether the Viewer using audio with the administrator privileges of RM Viewer, etc. is connected to the camera. • Audio can only be used by authorized users and guest users if [Audio Distribution] privileges are assigned. Ask your administrator to assign [Audio Distribution] privileges in [Basic] > [User Management] > [User Authority]. • If the Viewer is opened with Internet Explorer 10 or 11 on a 64-bit operating system, the audio may not be able to be received or transmitted if the enhanced protected mode is enabled. In this case, add the camera to the list of trusted sites and disable the protected mode of trusted sites.
The camera cannot be controlled.	<ul style="list-style-type: none"> • If you connect the Camera Viewer as an administrator, you will have exclusive possession of the camera control privileges. If you connect to the Viewer as an authorized user or guest user, you cannot control the camera unless the administrator releases camera control. Consult the administrator (P. 53).
The viewer gets disconnected.	<ul style="list-style-type: none"> • Check the network and computer for abnormality. • Reboot the computer and connect again. • Connections from authorized users and guest users are disconnected while creating a panorama image. R1x M50
You forgot the administrator password.	<ul style="list-style-type: none"> • You can initialize all settings of the camera excluding date and time using the reset switch (P. 247). After performing initialization, use the Camera Management Tool to register the administrator account again. The IP address and subnet mask, etc. also need to be set again because the network settings are initialized.
Data cannot be uploaded.	<ul style="list-style-type: none"> • Check that the upload destination of [Video Record] > [Upload] and the upload operation upon an event of the [Event] menu are both set correctly. • The settings for an upload destination that has been applied can be checked by executing a server upload test in [Video Record] > [Upload] on the Setting Page (P. 158). • Check [Maintenance] > [Log] > [View Logs] > [View Logs] or logs on the server to check the detailed operating environment. For details on [View Logs], please refer to "Uploader error" (P. 235), "Uploader warning" (P. 239), or "Uploader notification" (P. 242) of "List of Log Messages". Also please refer to "Important" on P. 158. • For the server settings, contact your system administrator.
Video cannot be recorded on a memory card.	<ul style="list-style-type: none"> • Check [Memory Card] > [Memory Card Information] on the Setting Page (P. 219). • Video cannot be recorded if the memory card has insufficient space and [Memory Card] > [Memory Card Operations] > [Overwrite videos] is set to [Disable] on the Setting Page (P. 218). Set [Overwrite videos] to [Enable] or use the Recorded Video Utility to delete unnecessary videos. • To record video to a memory card when an event occurs, check the [Video Record Action] settings under [Memory Card] > [Video Record Settings] on the Setting Page. When [Video Record Action] is set to [Upload], change it to [Record to Memory Card]. • When recording-mode stream video that could not be transmitted due to network errors or video for which the HTTP/FTP upload failed is not stored on the memory card, check [Operation Settings] under [Memory Card] > [Memory Card Operations] on the Setting Page. When [Operation Settings] is set to [Save Log], change it to [Save Logs and Videos]. • To manually save recordings to a memory card, obtain camera control privileges.
Files cannot be saved.	<ul style="list-style-type: none"> • Windows prohibits saving to certain folders. Accordingly, an attempt to save a file may fail. Specify [Documents], [Pictures] and other folders.

List of Log Messages

Log Messages on the Camera

The list of log messages displayed in [View Logs] in [Maintenance] > [Log] > [View Logs] on the Setting Page (P. 224). Log messages are classified into the following types.

Category	Level	Code	Fault level
crit	Error	4xx	Software-level failure (Task operations will stop)
err	Error	3xx	Operational error (Operations will continue)
warning	Warning	2xx	Non-operational error
notice	Warning	1xx	Error external to the system
info	Information	0xx	Information on normal operation

Note

If no content is recorded in a log for approximately two hours, "-- MARK --" will be recorded in the message area.

Error Log

■ System Error

S302 Error on saving settings [err]

Description	Can't update system settings (S302)
Meaning	An error generated while the system was saving a setting. Setting could not be saved.
Countermeasure	Provide enough memory space by deleting unnecessary files in the user memory area, etc.

S303 Error on saving settings [err]

Description	Can't update files of system settings (S303)
Meaning	An error generated while the system was saving a setting. Setting could not be saved.
Countermeasure	Provide enough memory space by deleting unnecessary files in the user memory area, etc.

S307 Error on saving settings [err]

Description	(vbadm.c XXX) Can't update system settings (S307)
Meaning	An error generated while the settings were saved by the setup protocol. Setting could not be saved.
Countermeasure	Provide enough memory space by deleting unnecessary files in the user memory area, etc.

S310 Working error in event service [err]

Description	cannot work event [%1][%2][%3] (S310)
%1	Error number
%2	Cause of error
%3	Error information
Meaning	An error occurred while the event service was running.
Countermeasure	If the problem persists after rebooting, the camera is faulty. Arrange for servicing.

S311 Working error in external input/output service [err]

Description	cannot work extio [%1][%2][%3] (S311)
%1	Error number
%2	Cause of error
%3	Error information
Meaning	An error occurred while the external input/output device service was running.
Countermeasure	If the problem persists after rebooting, the camera is faulty. Arrange for servicing.

S312 Working error in timer service [err]

Description	cannot work timer [%1][%2][%3] (S312)
%1	Error number
%2	Cause of error
%3	Error information
Meaning	An internal error occurred in the timer service.
Countermeasure	If the problem persists after rebooting, the camera is faulty. Arrange for servicing.

S320 PAN/TILT operation error [err]

Description	%1 error occurred. [%2] (S320)
%1	PAN TILT
%2	Warning details
Meaning	An error occurred during operation or stopping of PAN/TILT.
Countermeasure	Check that the camera is not touching the dome, etc. If the error is not caused by problems such as contact with peripheral items, the camera is faulty. Arrange for servicing.

S330 Failure of fan [err]

Description	fan [%1] is stopped (S330)
%1	Fan number
Meaning	Detected that the fan is not rotating or the rotation speed has significantly decreased.
Countermeasure	If the problem persists after rebooting, the fan may have failed. Arrange for servicing.

S331 Failure of heater [err]

Description	HEATER [%1] failure (S331)
%1	Heater number
Meaning	An abnormality was detected when using the heater.
Countermeasure	There may be a connection problem with the heater unit you attached, so check the connections. If the problem persists after rebooting, the heater may have failed. Arrange for servicing.

S410 Event service initialization error [crit]

Description	event initialization error [%1][%2] (S410)
%1	Error number
%2	Cause of error
Meaning	An error occurred in the initialization of the event service.
Countermeasure	If the problem persists after rebooting, the camera is faulty. Arrange for servicing.

S411 External input/output service initialization error [crit]

Description	extio initialization error [%1][%2] (S411)
%1	Error number
%2	Cause of error
Meaning	An error occurred in the initialization of the external input/output device service.
Countermeasure	If the problem persists after rebooting, the camera is faulty. Arrange for servicing.

S412 Timer service initialization error [crit]

Description	timer initialization error [%1][%2] (S412)
%1	Error number
%2	Cause of error
Meaning	An error occurred in the initialization of the timer service.
Countermeasure	If the problem persists after rebooting, the camera is faulty. Arrange for servicing.

S413 Timer service runtime error [crit]

Description	timer working error [%1] (S413)
%1	Error number
Meaning	An error occurred while the timer service was running.
Countermeasure	If the problem persists after rebooting, the camera is faulty. Arrange for servicing.

S420 External IO controller has failed [crit]

Description	external io controller is broken.(S420)
Meaning	The external IO controller has failed.
Countermeasure	The external IO controller firmware must be updated. If the problem persists after updating the firmware, the camera is faulty. Arrange for servicing.

S430 Failure of temperature sensor [crit]

Description	cannot get temperature (S430)
Meaning	The temperature cannot be acquired from the temperature sensor.
Countermeasure	If the problem persists after rebooting, the circuit board may have failed. Arrange for servicing.

■ Audio server error

B301 Audio device error [err]

Description	cannot use audio device for %1[%2:%3] (B301)
%1	Send/Receive type (rx tx)
%2	Error type (open write flush)
%3	Error number
Meaning	Detected an error in the audio device
Countermeasure	If the problem persists, please arrange for servicing.

B402 Audio server initialization failed [err]

Description	wvaudio initialization error [%1] (B402)
%1	Error number
Meaning	The audio server could not be initialized. The audio server stops.
Countermeasure	If the problem persists after rebooting, the camera is faulty. Arrange for servicing.

B403 Settings change failed [err]

Description	cannot set config [%1:%2] (B403)
%1	Error notification number
%2	Error number
Meaning	The settings could not be updated. The audio server stops.
Countermeasure	If the problem persists after rebooting, the camera is faulty. Arrange for servicing.

■ Video error

V300 Video input error [err]

Description	video %1 warning - %2 (V300)
%1	Video number
%2	Error number
Meaning	An error in the video input was detected that may adversely affect the operation of the camera.
Countermeasure	If the problem persists after rebooting, the camera is faulty. Arrange for servicing.

V320 Internal error in intelligent service [err]

Description	cannot work intelligent [%1][%2][%3]. (V320)
%1	Error number
%2	Cause of error
%3	Error information
Meaning	An internal error occurred in intelligent service.
Countermeasure	If the problem persists after rebooting, the camera is faulty. Arrange for servicing.

V321 Pseudo mode setting error in intelligent service [err]

Description	pseudo mode setting fail. (V321)
Meaning	An error occurred in the pseudo mode setting of intelligent service.
Countermeasure	If the problem persists after rebooting, the camera is faulty. Arrange for servicing.

V400 Video input initialization error [crit]

Description	video %1 initialization failure - %2(%3) (V400)
%1	Video number
%2	Process description
%3	Error details
Meaning	The video input function was stopped because the video input system could not be initialized.
Countermeasure	If the problem persists after rebooting, the camera is faulty. Arrange for servicing.

V401 Video input command error [crit]

Description	video %1 command error - %2(%3) (V401)
%1	Video number
%2	Process description
%3	Error details
Meaning	The video input function was stopped because a video input command could not be processed.
Countermeasure	If the problem persists after rebooting, the camera is faulty. Arrange for servicing.

V402 Video input frozen [crit]

Description	video %1 stalled (V402)
%1	Video number
Meaning	The video input function was stopped because video generation stopped.
Countermeasure	If the problem persists after rebooting, the camera is faulty. Arrange for servicing.

V403 Video input error [crit]

Description	video %1 fatal error - %2 (V403)
%1	Video number
%2	Error number
Meaning	The video input function was stopped because an error that does not permit recovery of the video input system was detected.
Countermeasure	If the problem persists after rebooting, the camera is faulty. Arrange for servicing.

V420 Could not start intelligent service [crit]

Description	intelligent initialization error [%1][%2]. (V420)
%1	Error number
%2	Cause of error
Meaning	Failed to initialize intelligent service.
Countermeasure	If the problem persists after rebooting, the camera is faulty. Arrange for servicing.

V421 Intelligent service error [crit]

Description	intelligent working error [%1][%2]. (V421)
%1	Error number
%2	Cause of error
Meaning	An error that does not permit recovery occurred while intelligent service was running.
Countermeasure	If the problem persists after rebooting, the camera is faulty. Arrange for servicing.

■ **Uploader error****A470 Uploader initialization failed [crit]**

Description	uploader initialization failure - %1 (A470)
%1	Error number
Meaning	The uploader could not be initialized.
Countermeasure	If the problem persists after rebooting, the camera is faulty. Arrange for servicing.

■ **Memory card error****M301 Memory card control module error [err]**

Description	%1 process failure (M301)
%1	mount or unmount
Meaning	Mount or unmount process failed.

M302 Cannot remove invalid file [err]

Description	Invalid file (%1) can not remove. (M302)
%1	Name of removed file
Meaning	The invalid file could not be removed.

M303 Cannot process directory [err]

Description	Can not open directory(%1)(M303)
%1	Directory name
Meaning	Could not open directory to be processed.

M304 Failed to recreate management information [err]

Description	Fail updating management file(%1)(M304)
%1	Management information identification number
Meaning	Process to recreate management information failed.

M305 Error when writing a video file [err]

Description	write error %1 (%2) (M305)
%1	Video file path
%2	Reason for error
Meaning	An error occurred when writing a video file.

M400 Failed to initialize a memory card [crit]

Description	Fail SD card initialization(%1).(M400)
%1	Card initialization NG (det), power supplies control NG (proc)
Meaning	Process to initialize a memory card failed.

■ ONVIF error (RTP)

R301 Distribution communication error [err]

Description	message queue open error. %1 (R301)
%1	Modules that generate errors RTP_CTRL_QUEUE RTP_DATA_QUEUE VIDEO_CTRL_QUEUE VIDEO_DATA_QUEUE AUDIO_CTRL_QUEUE AUDIO_DATA_QUEUE EVENT_CTRL_QUEUE RECVQ_META SENDQ_MEDIA
Meaning	A communication error occurred between modules.
Countermeasure	If the problem persists after repeated attempts and rebooting, the camera may be faulty. Arrange for servicing.

R302 Parameter acquisition failure [err]

Description	cannot get parameter: %1 (R302)
%1	user_account: User account IP_address: IP address of the camera profile_media_configuration: MediaConfiguration information RTSP_port_number: RTSP port number
Meaning	Parameter acquisition has failed.

R303 Metadata distribution initialization failure [err]

Description	metadata initialization error (R303)
Meaning	Metadata distribution initialization has failed.

R304 Abnormal termination of client [err]

Description	delete session from some kind of error: client_IP=%1, session_ID=%2 (R304)
%1	Client IP address
%2	Session ID
Meaning	The client session terminated abnormally.

R304 Client disconnected [err]

Description	connection reset by peer: client_IP=%1 (R304)
%1	Client IP address
Meaning	Disconnected from client.

R304 Client disconnected [err]

Description	RTP/HTTP connection closed by client (R304)
Meaning	Disconnected from client.

R305 RTSP processing error [err]

Description	RTSP Error: error_code=500: Internal Server Error (R305)
Meaning	An RTSP processing error occurred.

■ System warning

S220 PAN/TILT operation warning [warning]

Description	%1 warning detected. [%2] (S220)
%1	PAN TILT
%2	Warning details
Meaning	An error occurred during operation or stopping of PAN/TILT.
Countermeasure	Check that the camera is not touching the dome, etc.

S230 Decrease of fan rotation speed [warning]

Description	fan [%1] speed is too slow. (S230)
%1	Fan number
Meaning	Detected decrease in fan rotation speed. If this happens frequently, arrange for servicing.

S231 Heater unit not operating [warning]

Description	A 24 V AC power source is not supplied to the heater unit. (S231)
Meaning	A heater unit is attached but not supplied with a 24 V AC power source.
Countermeasure	The 24 V AC power source required to operate the heater unit is not being supplied. Check the type of power source and the power connection.

■ HTTP server warning

H143 User name specification error [notice]

Description	(http_auth.c.XXX) get_password failed, IP:%1 (H143)
%1	IP address
Meaning	An unknown user was specified in user authentication. This log message may also be displayed during normal operations when using a web browser other than Internet Explorer/Microsoft Edge.

H144 Password specification error [notice]

Description	(http_auth.c.XXX) password doesn't match for %1 username%2, IP:%3 (H144)
%1	URL XSS vulnerability countermeasure implementation (process equivalent to ftpd)
%2	User Name
%3	IP address
Meaning	A wrong password was specified in user authentication.

H201 Timeout disconnect [warning]

Description	a request for %1 timed out after writing %d seconds (H201)
%1	Request URI
%d	360 (Timeout time)
Meaning	Disconnected due to HTTP server timeout (360 sec.).

■ wvhttp warning

W101 Invalid user name [notice]

Description	user <User name> not found (W101)
Meaning	The camera was accessed by an unauthorized user.

W102 Invalid password [notice]

Description	user <User name> password mismatch (W102)
Meaning	The password is invalid.

W130 Buffer recovered [notice]

Description	stream buffer recovered (W130)
Meaning	Image buffer for stream recording has recovered.

W201 Invalid panorama image [warning]

Description	corrupt panorama image - ignored (W201)
Meaning	Panorama image information acquisition failed.

W230 Buffer overflow [warning]

Description	stream buffer overflowed (W230)
Meaning	The image buffer for the stream recording overflowed and images were discarded.

■ Audio server warning

B101 Received unusual request [notice]

Description	%1 unusual request[%2] (B101)
%1	Client host's IP address
%2	Unusual type (400 404)
Meaning	Refused due to command error (400) and parameter error (404).

B102 Client connection denied [notice]

Description	%1 request denied[%2] (B102)
%1	Client host IP address
%2	Denial type (41 43 ...)
Meaning	Client connection was denied due to an authentication error (41), time specification error (42), insufficient resource (43), specification of unsupported codec (45), specification of unpermitted user level (47), too many clients (49) or invalid operation mode (4a).
Countermeasure	41: Check user name, password or user list used when connecting. 42: Check playtime or maximum connection time settings used when connecting. 43: Reconnect or restart. 45: Use supported client software. 47: Check user level used when connecting. 49: Check client number settings. 4a: Check if usage of audio server is enabled.

B103 Client forcibly disconnected [notice]

Description	%1 access denied[%2] (B103)
%1	Client host IP address
%2	Denial type (41 42 4a)
Meaning	Connection was initially permitted, but the setting has subsequently been changed to prohibit access, thereby triggering a forced disconnection (the denial type is the same with B102).

B201 Event notification failure [warning]

Description	cannot notify %1 event [%2] (B201)
%1	Event type (ald)
%2	Error number
Meaning	Failed to notify event.

B202 Event receive failure [warning]

Description	cannot rcv event [%1] (B202)
%1	Error number
Meaning	Failed to receive event.

B203 Audio message send failure [warning]

Description	audio message send error %1 [%2] (B203)
%1	Message type
%2	Error number
Meaning	Failed to send audio message.

B204 Audio message receive error [warning]

Description	audio message rcv error [%1:%2] (B204)
%1	Error number
%2	Reason for error
Meaning	Failed to receive audio message.

■ Camera application warning

C201 Day/Night Mode switching warning [warning]

Description	Can't switch Day/Night mode, because current mode is Auto.(C201)
Meaning	Day/Night Mode could not be switched.
Countermeasure	Set Day/Night Mode to manual.

C211 Camera control command overflow [warning]

Description	command queue overflowed (C211)
Meaning	The camera control command queue overflowed, and some commands were discarded.
Countermeasure	Allow a longer interval (200 ms) for sending the camera control command.

■ Video warning

V200 Video input warning [warning]

Description	video %1 warning - %2 (V200)
%1	Video number
%2	Error number
Meaning	An error that permits recovery of the video input system was detected.
Countermeasure	Change video size or video quality, or decrease data size for each JPEG image.

■ Uploader warning

A120 Resolution of upload destination name failed [notice]

Description	uploader cannot resolve the server name (A120)
Meaning	The name of the upload destination could not be resolved.

A121 Connection to upload destination failed [notice]

Description	uploader cannot connect to the server (A121)
Meaning	Execution of connect to upload destination failed.

A122 Connection to upload destination failed [notice]

Description	uploader cannot connect to the server (A122)
Meaning	The upload destination could not be connected due to a reason other than A120 and A121.

A134 Invalid upload setting (FTP/HTTP mode) [notice]

Description	ftp/http mode invalid. uploader set <none> forcibly (A134)
Meaning	The upload mode setting is invalid. The upload function was forcibly disabled.

A135 Invalid upload setting (FTP PORT/PASV mode) [notice]

Description	ftp port/pasv mode invalid. uploader set <pasv> forcibly (A135)
Meaning	The PORT/PASV mode setting in connection with FTP upload is invalid. The PASV mode was forcibly set.

A136 Invalid upload setting (HTTP notification only/image mode) [notice]

Description	http notice/image mode invalid. uploader set <image> forcibly (A136)
Meaning	The notification only/image mode setting in connection with HTTP upload is invalid. The image mode was forcibly set.

A137 Invalid upload setting (E-mail notification) [notice]

Description	mode invalid. uploader set <none> forcibly (A137)
Meaning	The e-mail notification setting is invalid. Email notification was forcibly disabled.

A138 Invalid upload setting (E-mail notification authentication mode) [notice]

Description	authentication mode invalid. uploader set <smtp auth> forcibly (A138)
Meaning	The setting for e-mail notification authentication mode is invalid. "SMTP_AUTH" was forcibly set.

A274 Event buffer for upload overflowed [warning]

Description	event queue is full (A274)
Meaning	Event buffer for upload overflowed.
Countermeasure	Make adjustments to reduce the number of event occurrences.

A275 Image buffer for upload overflowed [warning]

Description	buffer queue is full (A275)
Meaning	Image buffer for upload overflowed.
Countermeasure	Make adjustments to reduce the number of event occurrences. Also adjust the video quality, video size and frame rate for upload.

■ Memory card warning

M201 Memory card is write-protected [warning]

Description	Readonly filesystem (M201)
Meaning	A write-protected memory card is inserted.

M203 Not enough space on memory card [warning]

Description	There is not available space (M203)
Meaning	Insufficient memory card capacity.

M204 Invalid file removed [warning]

Description	Invalid file (%1) was removed. (M204)
%1	Name of removed file
Meaning	An invalid file was removed.

M205 Checking management information file [warning]

Description	%1 checking management file (M205)
%1	Start Finish
Meaning	The memory card may have been removed without being unmounted. Start/finish checking management information file.

M206 Invalid management information removed [warning]

Description	Invalid db information(%1)(%2) was removed(M206)
%1	Name of management information file containing invalid information
%2	ID of invalid information
Meaning	Invalid management information was removed.

M207 Memory card removed without unmounting [warning]

Description	Memory card was pulled before unmount. (M207)
Meaning	Memory card was removed when mounted.

■ ONVIF warning (RTP)

R101 RTP session timeout [notice]

Description	session timeout: session ID=%1 (R101)
%1	Session ID
Meaning	RTP session has timed out.

R102 Information acquisition failure (RTP payload size) [notice]

Description	cannot get parameter: RTP_payload_size (R102)
Meaning	Information acquisition has failed (RTP payload size).

R102 Information acquisition failure (IP address) [notice]

Description	cannot get parameter: IP_address (R102)
Meaning	Information acquisition has failed (IP address).

R103 RTSP authentication failure [notice]

Description	RTSP authorization error (R103)
Meaning	RTSP authentication has failed.

R107 RTSP connection failure [notice]

Description	RTSP Error: error_code=%d: Service Unavailable (R107)
%d	400: Value used for RTSP is invalid. 401: RTSP authentication failure or missing valid authentication information. 457: Playback time for RTSP is invalid. 501: An invalid RTSP option was used. 503: Failure to offer service, due to insufficient resources. The number of maximum RTP sessions, has passed the limit.
Meaning	RTSP connection has failed.

■ System notification

S001 System started [info]

Description	starting paramd (S001)
Meaning	Parameter management module started.

S002 System settings changed [info]

Description	Updated system settings. (S002)
Meaning	Settings not requiring rebooting were changed.

S010 Event service started [info]

Description	starting event (S010)
Meaning	The event service was started.

S011 Event service shut down [info]

Description	shutdown event (S011)
Meaning	The event service was shut down.

S012 External device service started [info]

Description	starting extio (S012)
Meaning	The external device input/output service was started.

S013 External device service shut down [info]

Description	shutdown extio (S013)
Meaning	The external device input/output service was shut down.

S014 Timer service started [info]

Description	starting timer (S014)
Meaning	The timer service was started.

S015 Timer service shut down [info]

Description	shutdown timer (S015)
Meaning	The timer service was shut down.

S017 qtimer service started or shut down [info]

Description	%1 qtimer (S017)
%1	(starting) or (stopping)
Meaning	The qtimer service was started or shut down.

S030 Heater unit detected [info]

Description	The heater unit is detected. (S030)
Meaning	A heater unit is attached.

S070 Change to certificate [info]

Description	%1: succeeded to %2 certificate (S070)
%1	ssl or 802.1X
%2	generate load delete restore
Meaning	A certificate was generated/loaded/deleted/restored

■ wvhttp notification

W001 Starting and stopping of system [info]

Description	%1 webview (W001)
%1	Starting or stopping
Meaning	wvhttp server (webview) has started or stopped.

W030 Startup and shutdown of WebView Livescope Client [info]

Description	%1%2 host=<Host>, user=<User>, prio=<Priority>(W030)
%1	W: WebView session, V: Session-less video client, N: Session-less event client
%2	+: Connect, -: Disconnect
Meaning	The camera server client was connected or disconnected.

W031 Transmitted video data size [info]

Description	%1= host=<Host>, user=<User>, video=<jpglh264>:<Number of frames> (W031)
%1	W: WebView session, V: Session-less video client
Meaning	When a client disconnected, the total data that was sent to the client is displayed in number of frames.

W040 Clearing to external memory [info]

Description	%1 the image storing - %2 (W040)
%1	Starting or stopping
%2	Reason for starting/stopping
Meaning	Started or stopped clearing stream recording to external memory.

■ Audio server notification

B001 Starting and stopping of audio server [info]

Description	%1 audio. (B001)
%1	starting stopping
Meaning	The audio server was started/shut down.

B011 Audio client connected [info]

Description	[%1] %2 connected n=%3 (B011)
%1	Client type (send rcv)
%2	Client host IP address
%3	Total number of clients
Meaning	An audio client was connected.

B012 Audio client closed [info]

Description	[%1] %2 closed n=%3 (B012)
%1	Client type (send rcv)
%2	Client host IP address
%3	Total number of clients
Meaning	An audio client was disconnected.

■ Camera application notification

C001 Starting and stopping of camera control module [info]

Description	%1 camerad (C001)
%1	starting stopping
Meaning	The camera control module started/ stopped.

C002 Camera application started and stopped [info]

Description	starting cameraappl (C002)
Meaning	The camera application started.

■ Video notification

V001 Starting and stopping of video server [info]

Description	%1 video (V001)
%1	Starting or stopping
Meaning	The video server was started/stopped.

V020 Starting intelligent service [info]

Description	starting intelligent. (V020)
Meaning	Intelligent service was started.

V021 Shutting down intelligence service [info]

Description	shutdown intelligent. (V021)
Meaning	Intelligent service was shut down.

■ Uploader notification

A004 Starting and stopping of uploader [info]

Description	%1 uploader (A004)
%1	Starting or stopping
Meaning	The uploader was started or stopped.

A040 Number of uploads (MAIL) [info]

Description	uploader mail: normal=%1 test=%2 (A040)
%1	Number of normal uploads.
%2	Number of test uploads.
Meaning	Shows the number of uploads executed.

A041 Number of uploads (FTP) [info]

Description	uploader ftp: normal=%1 test=%2 (A041)
%1	Number of normal uploads.
%2	Number of test uploads.
Meaning	Shows the number of uploads executed.

A042 Number of uploads (HTTP) [info]

Description	uploader http: normal=%1 test=%2 (A042)
%1	Number of normal uploads.
%2	Number of test uploads.
Meaning	Shows the number of uploads executed.

■ Memory card notification

M001 Starting and stopping of memory card control module [info]

Description	%1 sdctrl (M001)
%1	Starting or stopping
Meaning	The memory card control module (sdctrl) has started or stopped.

M002 Valid management information inserted [info]

Description	Valid db information (%1)(%2)(%3) was inserted (M002)
%1	Name of management information file with inserted valid information
%2	Directory number of valid information
%3	File number of valid information
Meaning	Added to management information as it appears to be a valid video file.

M003 Started/finished recreation of management information [info]

Description	%1 updating management file (%2)(M003)
%1	Start Finish
%2	Management information identification number
Meaning	Process to recreate management information finished.

■ ONVIF notification (RTP)

R001 Startup of RTP distribution module [info]

Description	starting media_plane (R001)
Meaning	RTP distribution module started.

R002 Stopping of RTP distribution module [info]

Description	stopping media_plane (R002)
Meaning	RTP distribution module stopped.

R003 RTSP PLAY request received [info]

Description	PLAY received: client_IP=%1, profile=%2, num_of_sessions=%3(V=%4, A=%5, M=%6,BC=%7) (R003)
%1	Client IP address
%2	Profile name of requested PLAY
%3	Total number of client sessions
%4	Total distribution count of Video stream
%5	Total distribution count of Audio stream
%6	Total distribution count of Metadata stream
%7	Total distribution count of AudioBackChannel
Meaning	RTSP PLAY request was received.

R004 RTSP TEARDOWN request received [info]

Description	TEARDOWN received: client_IP=%1, profile=%2, num_of_sessions=%3(V=%4, A=%5, M=%6,BC=%7) (R004)
%1	Client IP address
%2	Profile name of requested TEARDOWN
%3	Total number of client sessions
%4	Total distribution count of Video stream
%5	Total distribution count of Audio stream
%6	Total distribution count of Metadata stream
%7	Total distribution count of AudioBackChannel
Meaning	RTSP TEARDOWN request was received.

R005 Starting multicast [info]

Description	start multicast: profile=%1, num_of_sessions=%2(V=%3, A=%4, M=%5,BC=%6) (R005)
%1	Client IP address
%2	Profile name of requested MulticastStreaming START
%3	Total distribution count of Video stream
%4	Total distribution count of Audio stream
%5	Total distribution count of Metadata stream
%6	Total distribution count of AudioBackChannel
Meaning	Multicast was started.



R006 Stopping multicast [info]

Description	stop multicast: profile=%1, num_of_sessions=%2(V=%3, A=%4, M=%5,BC=%6) (R006)
%1	Client IP address
%2	Profile name of requested MulticastStreaming STOP
%3	Total distribution count of Video stream
%4	Total distribution count of Audio stream
%5	Total distribution count of Metadata stream
%6	Total distribution count of AudioBackChannel
Meaning	Multicast was stopped.

List of Viewer Messages

Messages Displayed in the Information Display

Messages displayed in the information display of the Camera Viewer are classified into the following three types.

Icon	Category	Explanation
	Information Message	Displays help messages related to various buttons, pull-down lists, etc., as well as frame rate and other information.
	Warning Message	Displays a message urging caution to the user when camera control privileges cannot be obtained, the audio session stops, etc.
	Error Message	Displayed when a system error occurs in the viewer.

Warning Message

Message	Explanation
The camera is busy.	The connection limit was exceeded.
Failed to get camera control privileges.	The request for camera control privileges was denied because the camera was being used by the administrator, etc.
You are not connected to the camera.	An attempt was made to operate the camera when the camera was not connected.
Please get camera control privileges.	An attempt was made to operate the camera without camera control privileges.
Another user is already connected as an administrator.	The administrator is already connected to the camera.
No audio device. R13 R11 M50 H65x M641 H761 H751 M741	The [Audio Reception] button or [Audio Transmission] button was clicked while the computer audio device was unavailable or disabled.
Insufficient memory card capacity.	An attempt was made to manually record to a memory card with insufficient capacity.
Recording to memory card is not allowed.	Recording to the memory card failed because [Memory Card Operations] > [Operation Settings] was not set to [Save Logs and Videos].
You cannot control the camera unless you exit Digital PTZ and Viewer PTZ. M50	The video display area was clicked with the Digital PTZ or Viewer PTZ enabled.
You cannot control the camera unless you exit Viewer PTZ. R1x H65x M64x H76x H751 M74x	The video display area was clicked with the Viewer PTZ enabled.
Start Digital PTZ or Viewer PTZ. H65x M64x H76x H751 M74x	You clicked the pan/tilt slider, zoom slider, or video display area with the Digital PTZ and Viewer PTZ disabled.
Waiting for control privileges.	A general user is waiting to obtain control.
Recreating video management information.	The video management information on the memory card is being recreated.
User authentication failed.	User authentication failed, or the [Audio Transmission] button was clicked with [Audio Distribution] cleared for an authorized user in [User Authority] when connecting as an authorized user.
Failed to initialize the ActiveX plug-in.	When the ActiveX plug-in is not installed after starting the Camera Viewer, the Camera Viewer waits 10 seconds for the plug-in to be installed, but the plug-in was not installed after 10 seconds.
JavaScript is not available or disabled on your web browser.	JavaScript could not be used in the web browser.

Message	Explanation
Currently in the process of starting or ending audio transmission and receiving. R13 R11 M50 H65x M641 H761 H751 M741	Attempted to start or stop audio transmission while already processing starting or stopping of audio transmission and reception.
Cannot be controlled, because it is set to fixed at infinity mode.	You tried to operate the focus when [Focus] was set to [Fixed at infinity].
Cannot be controlled, because it is set to manual mode.	You tried to operate the Back Light Compensation button or exposure compensation when [Exposure] was set to [Manual], or [Smart Shade Control] was set to [Auto].
You do not have video reception permission.	A user without video reception privileges tried to connect to the camera.
Cannot be controlled, because Clear IR Mode is enabled. M50 H761	You tried to operate Day/Night with [Clear IR Mode] enabled.
Audio reception is restricted. R13 R11 M50 H65x M641 H761 H751 M741	You clicked the audio reception button when [Server] > [Audio Server] > [Audio Transmission from the Camera] was set to [Disable].
Audio transmission is restricted. R13 R11 M50 H65x M641 H761 H751 M741	You clicked the audio transmission button when [Server] > [Audio Server] > [Audio Reception from Viewer] was set to [Disable].
Your web browser is not supported.	You started the Camera Viewer with an unsupported web browser.
ActiveX is disabled.	ActiveX is disabled in the web browser settings or system functions cannot be accessed from ActiveX due to security settings.
Cannot be controlled, because the smart shade control is set to auto.	The [BLC] button was operated when [Smart Shade Control] was set to [Auto].

Restoring Factory Default Settings

If you have forgotten the settings and want to set the camera from the beginning, restore the factory default settings first. It is recommended that you use [Settings Page] > [Maintenance] > [Backup / Restore] to create a backup file before restoring the factory default settings (P. 222).

Important

If you restore default settings, you will become unable to connect to the camera because the administrator account is also initialized. Use the Camera Management Tool to configure the initial settings (P. 37).

Note

- Settings can also be backed up using the Camera Management Tool. For details on using the Camera Management Tool, please refer to "Camera Management Tool User Manual".
- For factory default settings, please refer to P. 251.

Restoring the Initial Settings from a Web Browser

Use [Maintenance] > [General] > [Initialization] > [Network Settings] > [Do not save] on the Setting Page (P. 220).

Restoring Factory Default Settings with the Reset Switch on the Camera

If you have forgotten or do not know the IP address of the camera or your Administrator password, you cannot operate the camera via the network. In this case, reset the camera.

Prepare the camera for being reset in advance.

In order to press the reset switch or reboot switch, it may be necessary to remove items such as the dome case or cover. For details, please refer to "Installation Guide" included with the camera.

R13 (VB-R13VE) **R12** **R11** (VB-R11VE) **R10** **M50** **H651** **M64x** **H76x** **M74x** **H751**

- 1** Hold down the reset switch while pressing the reboot switch with a pointed object.
- 2** Release the reboot switch after at least three seconds while still holding down the reset switch.
- 3** Release the reset switch when the LED (blue) starts flashing.

When the LED stops flashing, the reset procedure is complete.

VB-R13VE/VB-R12VE

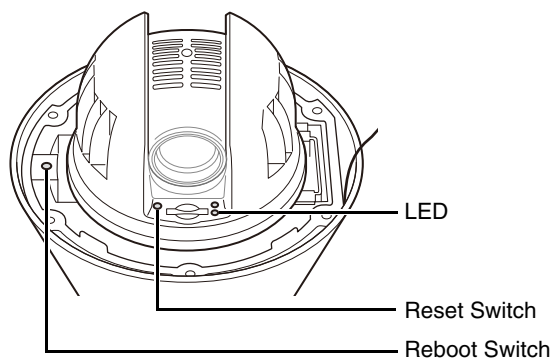

VB-M50B

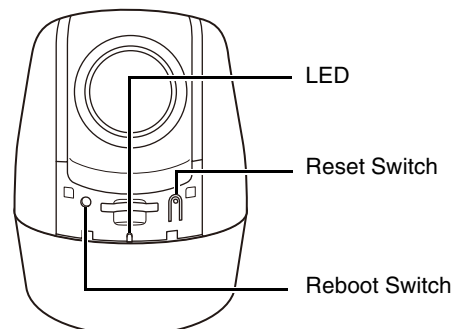

VB-R11VE/VB-R10VE

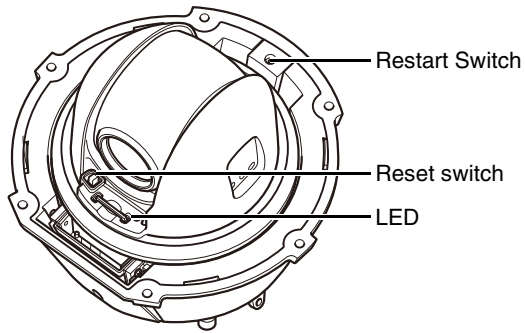

VB-M641VE/VB-M640VE

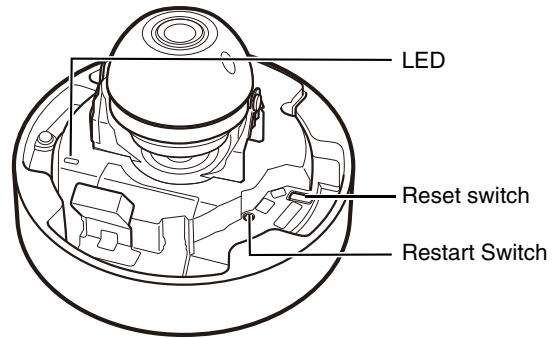

VB-H651VE

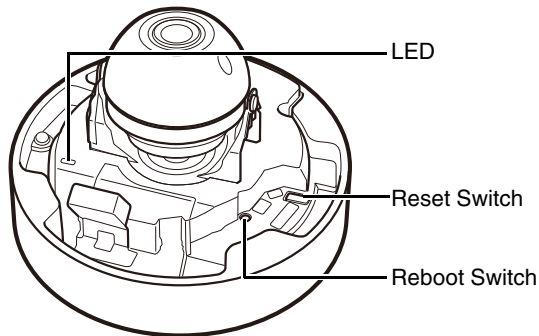

VB-H651V

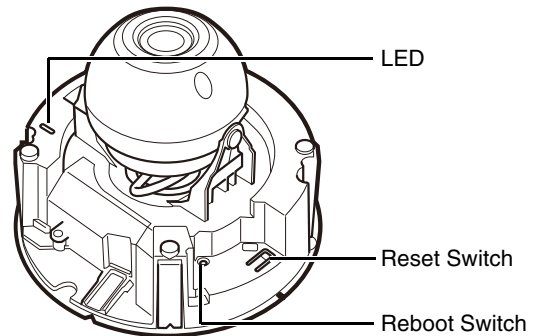

VB-M641V/VB-M640V

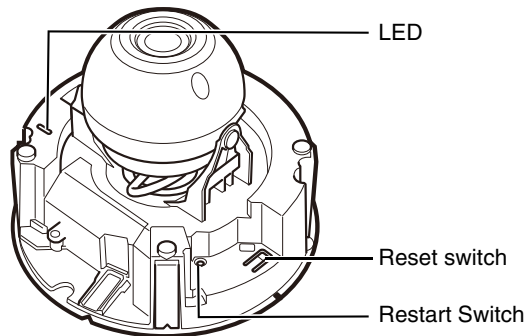

VB-M741LE-H/VB-M741LE/VB-M740E

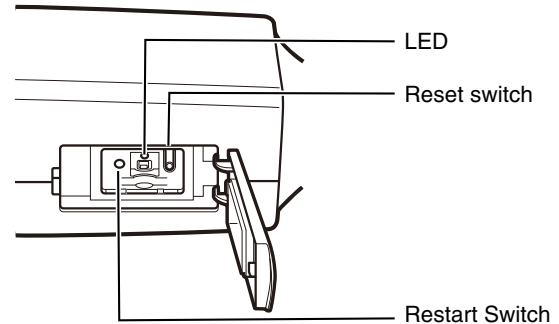

VB-H761LVE-H/VB-H761LVE/VB-H760VE/VB-H751LE-H/VB-H751LE

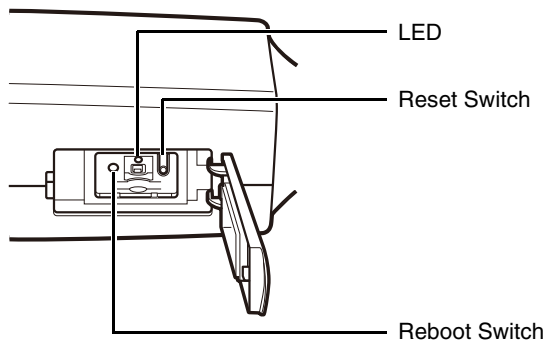

R13 (VB-R13)

- 1 Turn the camera off.

The camera does not have a power switch. To turn the camera on or off, connect or disconnect the power cable.

- 2 Hold down the reset switch and connect the power cable. Continue to hold the reset switch for five seconds or longer.

The LED will flash.

3 Release the reset switch.

When the LED stops flashing, the reset procedure is complete.

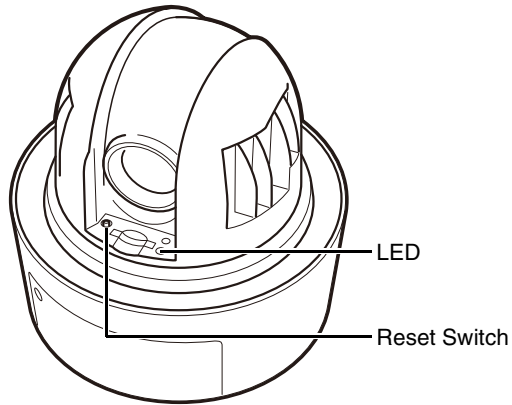

R11 (VB-R11)

1 Turn the camera off.

The camera does not have a power switch. To turn the camera on or off, connect or disconnect the power cable.

2 Hold down the reset switch and connect the power cable. Continue to hold the reset switch for five seconds or longer.

The LED will flash.

3 Release the reset switch.

When the LED stops flashing, the reset procedure is complete.

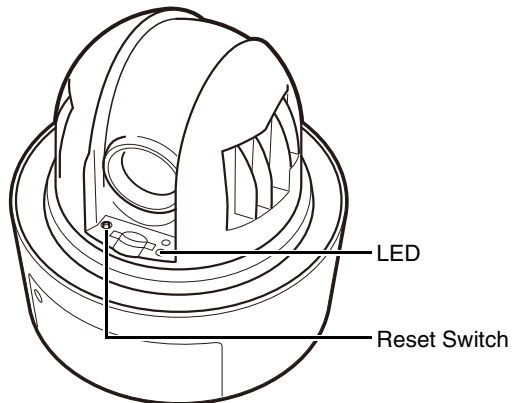

- 1** Incline the installation adjustment switch to the RESET position while pressing the reboot switch with a pointed object.
- 2** Release the reboot switch after at least three seconds while still inclining the installation adjustment switch.
- 3** Release the installation adjustment switch when the LED starts flashing.

When the LED stops flashing, the reset procedure is complete.

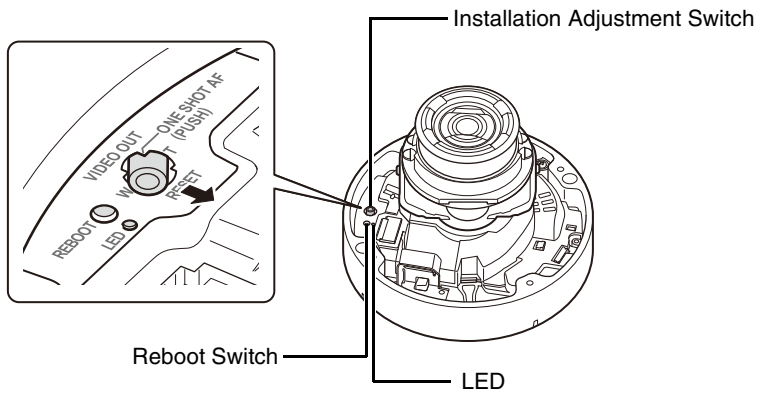

List of Factory Default Settings

Item	Setting
• LAN	
LAN Interface	Auto
Maximum Packet Size	1500
• IPv4	
IPv4 Address Settings Method	Auto (DHCP) R13 R12 M50 H65x H76x H751 Manual R11 R10 M64x M74x
IPv4 Address	192.168.100.1
Subnet Mask	255.255.255.0
IPv4 Default Gateway Address	
AutoIP	Enable
IPv4 Address (AutoIP)	
• IPv6	
IPv6	Enable
Auto (RA)	Enable
Auto (DHCPv6)	Enable
IPv6 Address (Manual)	
Prefix Length	64
IPv6 Default Gateway Address	
IPv6 Address (Auto)	
• DNS	
Name Server Address 1	
Name Server Address 2	
Set Name Server Address Automatically	Disable
Host Name	
Host Name Registration with DDNS	Do Not Register
Search Domain	
Search Domain List	
• mDNS	
Use mDNS	Enable
• Administrator Account	
Administrator Name	
Password	
• User Authority	

Item	Setting
Authorized User Camera Control	Video Distribution and Privileged Camera Control
Guest User Camera Control	Video Distribution and Camera Control
Authorized User Audio Distribution R13 R11 M50 H65x M641 H761 H751 M741	Yes
Guest User Audio Distribution R13 R11 M50 H65x M641 H761 H751 M741	Yes
• Current Date and Time	
• Settings	
Settings Method	Set manually
Set NTP Server Settings Automatically	Disable
NTP Server	
Time zone	(GMT+09:00) Osaka, Sapporo, Tokyo
Daylight Saving Time	Disable
■ R13 R12 H65x H76x H751	
• All Videos	
Video Size Set	1920 x 1080 / 960 x 540 / 480 x 270
• JPEG	
Video Quality: 480 x 270	6
Video Quality: 960 x 540	6
Video Quality: 1920 x 1080	6
Video Quality: Digital PTZ H65x H76x H751	6
Video Size: video Transmission	1920 x 1080
Maximum Frame Rate: Video Transmission	15.0
Video Size: Upload / Memory card	480 x 270
• H.264(1)	
Video Size	1920 x 1080
Bit Rate Control	Use bit rate control
Target Bit Rate (kbps)	3072
Video Quality	6
Frame Rate (fps)	15
I Frame Interval (sec)	1
• H.264(2)	
Enable in H.264(2)	Disable
Video Size	480 x 270

Item	Setting
Bit Rate Control	Use bit rate control
Target Bit Rate (kbps)	1024
Video Quality	6
Frame Rate (fps)	15
I Frame Interval (sec)	1
<ul style="list-style-type: none"> R11 R10 M50 M64x M74x 	
<ul style="list-style-type: none"> All Videos 	
Video Size Set	1280 x 720 / 640 x 360 / 320 x 180
<ul style="list-style-type: none"> JPEG 	
Video Quality: 320x180	6
Video Quality: 640x360	6
Video Quality: 1280x720	6
Video Quality: Digital PTZ	6
Video Size: video Transmission	1280 x 720
Maximum Frame Rate: Video Transmission	15.0
Video Size: Upload / Memory card	320 x 180
<ul style="list-style-type: none"> H.264(1) 	
Video Size	1280 x 720
Bit Rate Control	Use bit rate control
Target Bit Rate (kbps)	3072
Video Quality	6
Frame Rate (fps)	15
I Frame Interval (sec)	1
<ul style="list-style-type: none"> H.264(2) 	
H.264(2)	Disable
Video Size	320 x 180
Bit Rate Control	Use bit rate control
Target Bit Rate (kbps)	1024
Video Quality	6
Frame Rate (fps)	15
I Frame Interval (sec)	1
<ul style="list-style-type: none"> General 	
Default Page	Display Settings Page
<ul style="list-style-type: none"> Viewer Settings 	
User Authentication	Authenticate
Rotate Video Display H65x M64x H76x H751 M74x	Do not rotate
H.264 for Guest Users	Disable
<ul style="list-style-type: none"> Camera Name 	

Item	Setting
Camera Name (alphanumeric characters)	Camera
<ul style="list-style-type: none"> Camera Control 	
Digital Zoom	Disable
Enhanced Digital Zoom R1x M50 H76x	Disable
Maximum Digital Zoom Magnification R1x M50 H76x	5
Image Stabilizer	Disable
Smart Shade Control Strength (Auto)	Medium
Haze Compensation Strength (Auto)	Medium
Infrared Light Strength (Auto) H652 H761 H751 M741	Strong
Motion-Adaptive Noise Reduction	Disable
Pan/Tilt Speed Control R1x M50	Control by zoom position
Auto Flip R1x	Enable
<ul style="list-style-type: none"> Day/Night (when Auto is set) 	
Switching Brightness	Standard
Response (sec.)	20
<ul style="list-style-type: none"> Clear IR Mode H761 	
Infrared Light Turn On Time	Specify Time
Light Turn-On Time	18:00
Light Turn-Off Time	06:00
<ul style="list-style-type: none"> Installation Conditions 	
LED Setting M50 H76x H751 M74x	Turn On
Video Flip	Disable
<ul style="list-style-type: none"> Camera Position Control 	
Restricted to Presets R1x M50 H76x	No Restriction
Camera Position without Control	Do not return to Home Position
<ul style="list-style-type: none"> External Input Device 1 R13 R11 M50 H65x M641 H761 H751 M741 	
Device Name (alphanumeric characters)	
<ul style="list-style-type: none"> External Input Device 2 R13 R11 M50 H65x M641 H761 H751 M741 	
Device Name (alphanumeric characters)	
<ul style="list-style-type: none"> External Output Device 1 R13 R11 M50 H65x M641 H761 H751 M741 	

Item	Setting
Device Name (alphanumeric characters)	
• External Output Device 2 R13 R11 M50 H65x M641 H761 H751 M741	
Device Name (alphanumeric characters)	
• Camera Position	
Pan/Tilt/Zoom position R1x M50	Register
Zoom Position H76x	Register
Digital PTZ Position M50 H65x M64x H76x H751 M74x	Do Not Register
• Camera Settings	
Focus	Auto R1x M50 H76x Manual H65x M64x H751 M74x
Exposure	Auto
AGC Limit	6
Shutter Speed Limit (Lower)	1/30
Shutter Speed Limit (Upper)	1/16000
Shutter Speed	1/1000
Aperture	11
Gain	9
Exposure Compensation	0
Metering Mode	Center-Weighted
Smart Shade Control	Disable
Smart Shade Control Level	1 (Mild)
White Balance	Auto
R Gain	255
B Gain	255
Noise Reduction	Standard
Sharpness	3
Color Saturation	4
Haze Compensation	Disable
Haze Compensation Level	4
Clear IR Mode M50 H761	Disable
Day/Night	Day Mode
Use Infrared Light H652 H761 H751 M741	Day/Night Operation
Infrared Light Level H652 H761 H751 M741	1 (Mild)
• Day/Night Mode Focus	
Day/Night Mode Focus Control	Use One-shot AF

Item	Setting
Light Source H65x M64x H652 H651 H751 M741	Fluorescent
• Camera Control	
Day/Night	Day Mode
• Panorama Creation Area R1x M50	
Specify the panorama creation area	Not specified
• Capture Settings R1x M50	
Exposure Lock	Center
White Balance Lock	Do not lock
Focus Lock	Do not lock
• View restriction R1x M50 H76x	
View Restrictions	Disable
• Register Preset	
Pan/Tilt/Zoom position R1x M50	Register
Zoom Position H76x H751	Register
Digital PTZ Position H65x M64x H751 M74x	Register
Camera Settings	Register R1x M50 H76x Do Not Register H65x M64x H751 M74x
Preset Name	preset 1
Show in Viewers	Enable
• Route List/Route	
Conditions to Enable Settings	Disable
Route Name R1x M50 H76x	
Specify Active Time	Not specified
Start Time	00:00
End Time	00:00
Reverse Route R1x M50 H76x	Disable
• Edit Tour Route	
Speed (PT) R1x M50	20 (Fast)
Speed (Z) R1x M50 H76x	8(Fast)
Pause Duration	0 R1x M50 H76x 1 H65x M64x H751 M74x
• Specified Area	
Area 1 (Pink)	Disable
Area 2 (Purple)	Disable
Area 3 (Blue)	Disable
Area 4 (Cyan)	Disable

Item	Setting
Area 5 (Green)	Disable
Area 6 (Yellow)	Disable
Area 7 (Orange)	Disable
Area 8 (White)	Disable
• ADSR	
Enable in H.264(1)	Disable
Enable in H.264(2)	Disable
Data Size Reduction Level	Hight
• On-screen display	
Date display	Disable
Position of date display	Upper left
Format of date display	YYYY/MM/DD
Time display	Disable
Position of time display	Upper left
Text display	Disable
Position of text display	Upper left
Text string display	
Color of text	White
Background color	Black
Color depth of text and background	Fill text and background color
• Mask area	
Area	Enable
• All privacy masks	
Color	Black
R13 R11 M50 H65x M641 H761 H751 M741	
• General Audio	
Input Volume	50
Output Volume	50
Echo Cancellor	Disable
Audio Input	Line In
• Sound Clip Upload 1	
Sound Clip Name	
• Sound Clip Upload 2	
Sound Clip Name	
• Sound Clip Upload 3	
Sound Clip Name	
• HTTP Server	
Authentication Method	Digest Authentication
HTTP Port	80
HTTPS Port	443
• SNMP Server	

Item	Setting
Use SNMP v1 and v2c	Disable
Use SNMP v3	Disable
Administrator Contact Information	
Administration Function Name	R13 VB-R13VE/VB-R13
	R12 VB-R12VE
	R11 R10 VB-R11VE/VB-R11 VB-R10VE
	M50 VB-M50B
	H652 VB-H652LVE
	H651 VB-H651VE/VB-H651V
	M641 M640 VB-M641VE/ VB-M641V/ VB-M640VE/VB-M640V
	H761 VB-H761LVE
	H760 VB-H760VE
	H751 VB-H751LE
	M741 M740 VB-M741LE/VB-M740E
Installation Location	
Security Level	No authentication and no encryption
Authentication Algorithm	MD5
Encryption Algorithm	DES
• SNMP v1 and v2c Server	
Community Name	
• SNMP v3 Server	
User Name	
Security Level	No authentication and no encryption
Authentication Algorithm	MD5
Encryption Algorithm	DES
• FTP Server	
Use FTP Server	Disable
User Name	
• WS-Security	
Check Time on Authentication	Check
• Video Server	
Maximum Number of Clients	30

Item	Setting
Camera Control Queue Length	30
Maximum Connection Time (sec.)	0
Camera Control Time (sec.)	20
R13 R11 M50 H65x M641 H761 H751 M741 Audio Server	
Audio Transmission from the Camera	Disable
Voice Activity Detection	Disable
Audio Reception from Viewer	Disable
• RTP Server	
RTP	Enable
RTSP Authentication Method	Digest Authentication
RTSP Port	554
• Audio Multicast R13 R11 M50 H65x M641 H761 H751 M741	
Multicast Address	0.0.0.0
Multicast Port	0
Multicast TTL	1
• RTP Stream 1	
Video Size	480 x 270 JPEG R13 R12 H65x H76x H751 320 x 180 JPEG R11 R10 M50 M64x M74x
Frame Rate	5
Multicast Address	0.0.0.0
Multicast Port	0
Multicast TTL	1
Audio Transmission R13 R11 M50 H65x M641 H761 H751 M741	Disable
• RTP Stream 2	
Video Size	480 x 270 JPEG R13 R12 H65x H76x H751 320 x 180 JPEG R11 R10 M50 M64x M74x
Frame Rate	10
Multicast Address	0.0.0.0
Multicast Port	0
Multicast TTL	1
Audio Transmission R13 R11 M50 H65x M641 H761 H751 M741	Disable

Item	Setting
• RTP Stream 3	
Video Size	480 x 270 JPEG R13 R12 H65x H76x H751 320 x 180 JPEG R11 R10 M50 M64x M74x
Frame Rate	15
Multicast Address	0.0.0.0
Multicast Port	0
Multicast TTL	1
Audio Transmission R13 R11 M50 H65x M641 H761 H751 M741	Disable
• RTP Stream 4	
Video Size	480 x 270 JPEG R13 R12 H65x H76x H751 320 x 180 JPEG R11 R10 M50 M64x M74x
Frame Rate	30
Multicast Address	0.0.0.0
Multicast Port	0
Multicast TTL	1
Audio Transmission R13 R11 M50 H65x M641 H761 H751 M741	Disable
• RTP Stream 5	
Video Size	H.264(1)
Frame rate	5
Multicast Address	0.0.0.0
Multicast Port	0
Multicast TTL	1
Audio Transmission R13 R11 M50 H65x M641 H761 H751 M741	Disable
• Video Record Settings	
Video Record Action	Upload
• General Upload	
Upload	Upload Disabled
Video Format	JPEG
Frame Rate	1
Pre-event Buffer (number of frames)	0
Post-event Buffer (number of frames)	0
Pre-event Buffer (sec)	0
Post-event Buffer (sec)	0

Item	Setting
<ul style="list-style-type: none"> HTTP Upload <ul style="list-style-type: none"> Notification URI User Name Proxy Server Proxy Port Proxy User Name Parameter (query string) FTP Upload <ul style="list-style-type: none"> Notification FTP Server User Name PASV Mode File Upload Path File Naming <ul style="list-style-type: none"> Maximum Number of Loops Subdirectory Name to Create File Name to Create File Name to Create 	<p>Notification Only with HTTP</p> <p>80</p> <p>Video data upload with FTP</p> <p>Enable</p> <p>YYYYMMDDHHMMSS ms</p> <p>0</p> <p>image.jpg</p> <p>video.mov</p>
<ul style="list-style-type: none"> E-mail Notification <ul style="list-style-type: none"> Notification Mail Server Name Mail Server Port Sender (From) Recipient (To) Authentication <ul style="list-style-type: none"> User Name POP Server Subject Message Body 	<p>Text Only</p> <p>25</p> <p>None</p>
<p>R13 R11 M50 H65x M641 H761 H751 M741</p> <ul style="list-style-type: none"> External Device Output 1 <ul style="list-style-type: none"> Operation Mode Active Output Format Pulse Output Time (sec) External Device Output 2 <ul style="list-style-type: none"> Operation Mode Active Output Format Pulse Output Time (sec) 	<p>Normally Open</p> <p>Continuous</p> <p>1</p> <p>Normally Open</p> <p>Continuous</p> <p>1</p>

Item	Setting
<ul style="list-style-type: none"> External Device Input <ul style="list-style-type: none"> External Device Input Event External Device Input 1 <ul style="list-style-type: none"> Operation Mode Active Event Operation Inactive Event Operation Ongoing Active Event Operation Preset <ul style="list-style-type: none"> R13 R11 M50 H761 Video Record E-mail Notification External Device Output for Active Event External Device Output for Inactive Event Audio Playback at Active Event Audio Playback at Inactive Event Sound Clip Volume Day/Night Mode Switching External Device Input 2 <ul style="list-style-type: none"> Operation Mode Active Event Operation Inactive Event Operation Ongoing Active Event Operation Preset <ul style="list-style-type: none"> R13 R11 M50 H761 Video Record E-mail Notification External Device Output for Active Event External Device Output for Inactive Event Audio Playback at Active Event Audio Playback at Inactive Event Sound Clip Volume Day/Night Mode Switching Volume Detection <ul style="list-style-type: none"> Volume Detection Event <ul style="list-style-type: none"> Detection Conditions Reference Volume Level 	<p>Enable</p> <p>Normally Open</p> <p>Disable</p> <p>Disable</p> <p>Disable</p> <p>None</p> <p>Disable</p> <p>Disable</p> <p>Disable</p> <p>Disable</p> <p>50</p> <p>Disable</p> <p>Normally Open</p> <p>Disable</p> <p>Disable</p> <p>Disable</p> <p>None</p> <p>Disable</p> <p>Disable</p> <p>Disable</p> <p>Disable</p> <p>50</p> <p>Disable</p> <p>Disable</p> <p>Disable</p> <p>50</p> <p>Disable</p> <p>Disable</p> <p>Disable</p> <p>Disable</p> <p>50</p> <p>Disable</p> <p>The reference volume level or above</p> <p>50</p>

Item	Setting
Detection Condition Duration (sec)	0
ON Event Operation	Disable
OFF Event Operation	Disable
Ongoing ON Event Operation	Disable
Preset R13 R11 M50 H761	None
Video Record	Disable
E-mail Notification	Disable
External Device Output for ON Event	Disable
External Device Output for OFF Event	Disable
• Scream Detection	
Scream Detection Event	Disable
ON Event Operation	Disable
Preset R13 R11 M50 H761	None
Video Record	Disable
E-mail Notification	Disable
External Device Output for ON Event	Disable
• Timer 1	
Timer Event	Disable
24-Hour Continuous Settings	Disable
Start Time	00:00
End Time	00:00
Repeat Interval	None
• Operation	
Start Time Preset R1x M50 H76x	None
Video Record	Disable
E-mail Notification	Disable
External Device Output R13 R11 M50 H761	Disable
Day/Night Mode Switching	Disable
• Timer 2	
Timer Event	Disable
24-Hour Continuous Settings	Disable
Start Time	00:00
End Time	00:00
Repeat Interval	None
• Operation	
Start Time Preset R1x M50 H76x	None
Video Record	Disable

Item	Setting
E-mail Notification	Disable
External Device Output R13 R11 M50 H761	Disable
• Timer 3	
Timer Event	Disable
24-Hour Continuous Settings	Disable
Start Time	00:00
End Time	00:00
Repeat Interval	None
• Operation	
Start Time Preset R1x M50 H76x	None
Video Record	Disable
E-mail Notification	Disable
External Device Output R13 R11 M50 H761	Disable
• Timer 4	
Timer Event	Disable
24-Hour Continuous Settings	Disable
Start Time	00:00
End Time	00:00
Repeat Interval	None
• Operation	
Start Time Preset R1x M50 H76x	None
Video Record	Disable
E-mail Notification	Disable
External Device Output R13 R11 M50 H761	Disable
• Operation Mode R1x	
Mode	Video Detection
■ Video Detection	
• Display Options	
Detection Area/Line	Selected Detection Settings Only
Non-detection Area	Only enabled non-detection areas
Detection Results	Selected Detection Settings Only
• Camera Position Settings R1x M50 H76x	
Lock camera position	Cleared
■ Auto Tracking R1x	
• Display Options	
Detection Area	Enable
Detection Results	Enable

Item	Setting
<ul style="list-style-type: none"> Camera Position Settings Specify the initial camera position 	Cleared
<ul style="list-style-type: none"> Day/Night Mode Switching Preset when Switching to Day Mode Preset when Switching to Night Mode 	None
<div style="display: flex; justify-content: space-between; margin-bottom: 5px;"> R13 R11 M50 H65x M641 </div> <div style="display: flex; justify-content: space-between; margin-bottom: 5px;"> H761 H751 M741 </div> <ul style="list-style-type: none"> Linked Event 1 Linked Event Event Linking Method Event Order Event Gap (seconds) Event 1 Event Type External Device Input External Device Input Status Event 2 Event Type Intelligent Function Intelligent Function Status Operation ON Event Operation OFF Event Operation Ongoing ON Event Operation Preset R13 R11 M50 H761 Video Record E-mail Notification External Device Output for ON Event External Device Output for OFF Event Audio Playback at ON Event Audio Playback at OFF Event Sound Clip Volume Linked Event 2 Linked Event Event Linking Method Event Order Event Gap (seconds) Event 1 Event Type 	Disable AND None 2 External Device Input Input 1 Active Intelligent Function Setting 1 on Disable Disable Disable None Disable Disable Disable Disable Disable Disable Disable 50 Disable AND None 2 External Device Input

Item	Setting
External Device Input	Input 1
External Device Input Status	Active
Event 2	
Event Type	Intelligent Function
Intelligent Function	Setting 1
Intelligent Function Status	on
Operation	
ON Event Operation	Disable
OFF Event Operation	Disable
Ongoing ON Event Operation	Disable
Preset	None
R13 R11 M50 H761	
Video Record	Disable
E-mail Notification	Disable
External Device Output for ON Event	Disable
External Device Output for OFF Event	Disable
Audio Playback at ON Event	Disable
Audio Playback at OFF Event	Disable
Sound Clip	
Volume	50
<ul style="list-style-type: none"> Linked Event 3 Linked Event Event Linking Method Event Order Event Gap (seconds) Event 1 Event Type External Device Input External Device Input Status Event 2 Event Type Intelligent Function Intelligent Function Status Operation ON Event Operation OFF Event Operation Ongoing ON Event Operation Preset R13 R11 M50 H761 Video Record E-mail Notification 	Disable AND None 2 External Device Input Input 1 Active Intelligent Function Setting 1 on Disable Disable Disable None Disable Disable

Item	Setting
External Device Output for ON Event	Disable
External Device Output for OFF Event	Disable
Audio Playback at ON Event	Disable
Audio Playback at OFF Event	Disable
Sound Clip	
Volume	50
• Linked Event 4	
Linked Event	Disable
Event Linking Method	AND
Event Order	None
Event Gap (seconds)	2
Event 1	
Event Type	External Device Input
External Device Input	Input 1
External Device Input Status	Active
Event 2	
Event Type	Intelligent Function
Intelligent Function	Setting 1
Intelligent Function Status	on
Operation	
ON Event Operation	Disable
OFF Event Operation	Disable
Ongoing ON Event Operation	Disable
Preset	None
R13 R11 M50 H761	
Video Record	Disable
E-mail Notification	Disable
External Device Output for ON Event	Disable
External Device Output for OFF Event	Disable
Audio Playback at ON Event	Disable
Audio Playback at OFF Event	Disable
Sound Clip	
Volume	50
• IPv4 Host Access Restrictions	
Apply Host Access Restrictions	Disable
Default Policy	Authorize Access
Network Address / Subnet	01: / 32 Yes
	02: / 32 Yes
	03: / 32 Yes
	04: / 32 Yes

Item	Setting
	05: / 32 Yes
	06: / 32 Yes
	07: / 32 Yes
	08: / 32 Yes
	09: / 32 Yes
	10: / 32 Yes
	11: / 32 Yes
	12: / 32 Yes
	13: / 32 Yes
	14: / 32 Yes
	15: / 32 Yes
	16: / 32 Yes
	17: / 32 Yes
	18: / 32 Yes
	19: / 32 Yes
	20: / 32 Yes
• IPv6 Host Access Restrictions	
Apply Host Access Restrictions	Disable
Default Policy	Authorize Access
Prefix / Prefix Length	01: / 128 Yes
	02: / 128 Yes
	03: / 128 Yes
	04: / 128 Yes
	05: / 128 Yes
	06: / 128 Yes
	07: / 128 Yes
	08: / 128 Yes
	09: / 128 Yes
	10: / 128 Yes
	11: / 128 Yes
	12: / 128 Yes
	13: / 128 Yes
	14: / 128 Yes
	15: / 128 Yes
	16: / 128 Yes
	17: / 128 Yes
	18: / 128 Yes
	19: / 128 Yes
	20: / 128 Yes
• Certificates	
Certificate Status	Not Installed
Country (C)	

Item	Setting
State/Province (ST)	
Locality (L)	
Organization (O)	
Organizational Unit (OU)	
Common Name (CN)	
Validity Period Start Date	
Validity Period End Date	
• Encrypted Communications	
HTTPS Connection Policy	HTTP
• 802.1X Authentication	
802.1X Authentication	Disable
Authentication Status	Stop
• Authentication Method	
Authentication Method	EAP-MD5
User Name	
• IPsec	
IPsec	Auto Key Exchange
• Auto Key Exchange Settings	
IPsec SA Encryption Algorithm	AES->3DES
IPsec SA Authentication Algorithm	HMAC_SHA1_96
IPsec SA Validity Period (min)	480
ISAKMP SA Encryption Algorithm	AES->3DES
ISAKMP SA Authentication Algorithm	SHA1
DH Group	Group 14->Group 5->Group 2
ISAKMP SA Validity Period (min)	480
• IPsec Set 1	
IPsec Set	Disable
IPsec Mode	Tunnel Mode
Destination IPv4 Address	
Destination IPv6 Address	
Source IPv4 Address	
Source IPv6 Address	
IPsec Protocol	ESP
Security Gateway IPv4 Address	
Security Gateway IPv6 Address	
Destination Subnet Mask Length	16
Destination Prefix Length	16
IKE Pre-Shared Key	
SA ESP Encryption Algorithm	AES
SA ESP Authentication Algorithm	HMAC_SHA1_96
SA ESP Encryption Key (outbound)	

Item	Setting
SA ESP Authentication Key (outbound)	
SA ESP SPI (outbound)	
SA ESP Encryption Key (inbound)	
SA ESP Authentication Key (inbound)	
SA ESP SPI (inbound)	
SA AH Authentication Algorithm	HMAC_SHA1_96
SA AH Authentication Key (outbound)	
SA AH SPI (outbound)	
SA AH Authentication Key (inbound)	
SA AH SPI (inbound)	
• IPsec Set 2	
IPsec Set	Disable
IPsec Mode	Tunnel Mode
Destination IPv4 Address	
Destination IPv6 Address	
Source IPv4 Address	
Source IPv6 Address	
IPsec Protocol	ESP
Security Gateway IPv4 Address	
Security Gateway IPv6 Address	
Destination Subnet Mask Length	16
Destination Prefix Length	16
IKE Pre-Shared Key	
SA ESP Encryption Algorithm	AES
SA ESP Authentication Algorithm	HMAC_SHA1_96
SA ESP Encryption Key (outbound)	
SA ESP Authentication Key (outbound)	
SA ESP SPI (outbound)	
SA ESP Encryption Key (inbound)	
SA ESP Authentication Key (inbound)	
SA ESP SPI (inbound)	
SA AH Authentication Algorithm	HMAC_SHA1_96
SA AH Authentication Key (outbound)	
SA AH SPI (outbound)	
SA AH Authentication Key (inbound)	
SA AH SPI (inbound)	

Item	Setting
• IPsec Set 3	
IPsec Set	Disable
IPsec Mode	Tunnel Mode
Destination IPv4 Address	
Destination IPv6 Address	
Source IPv4 Address	
Source IPv6 Address	
IPsec Protocol	ESP
Security Gateway IPv4 Address	
Security Gateway IPv6 Address	
Destination Subnet Mask Length	16
Destination Prefix Length	16
IKE Pre-Shared Key	
SA ESP Encryption Algorithm	AES
SA ESP Authentication Algorithm	HMAC_SHA1_96
SA ESP Encryption Key (outbound)	
SA ESP Authentication Key (outbound)	
SA ESP SPI (outbound)	
SA ESP Encryption Key (inbound)	
SA ESP Authentication Key (inbound)	
SA ESP SPI (inbound)	
SA AH Authentication Algorithm	HMAC_SHA1_96
SA AH Authentication Key (outbound)	
SA AH SPI (outbound)	
SA AH Authentication Key (inbound)	
SA AH SPI (inbound)	
• IPsec Set 4	
IPsec Set	Disable
IPsec Mode	Tunnel Mode
Destination IPv4 Address	
Destination IPv6 Address	
Source IPv4 Address	
Source IPv6 Address	
IPsec Protocol	ESP
Security Gateway IPv4 Address	
Security Gateway IPv6 Address	
Destination Subnet Mask Length	16
Destination Prefix Length	16
IKE Pre-Shared Key	
SA ESP Encryption Algorithm	AES

Item	Setting
SA ESP Authentication Algorithm	HMAC_SHA1_96
SA ESP Encryption Key (outbound)	
SA ESP Authentication Key (outbound)	
SA ESP SPI (outbound)	
SA ESP Encryption Key (inbound)	
SA ESP Authentication Key (inbound)	
SA ESP SPI (inbound)	
SA AH Authentication Algorithm	HMAC_SHA1_96
SA AH Authentication Key (outbound)	
SA AH SPI (outbound)	
SA AH Authentication Key (inbound)	
SA AH SPI (inbound)	
• IPsec Set 5	
IPsec Set	Disable
IPsec Mode	Tunnel Mode
Destination IPv4 Address	
Destination IPv6 Address	
Source IPv4 Address	
Source IPv6 Address	
IPsec Protocol	ESP
Security Gateway IPv4 Address	
Security Gateway IPv6 Address	
Destination Subnet Mask Length	16
Destination Prefix Length	16
IKE Pre-Shared Key	
SA ESP Encryption Algorithm	AES
SA ESP Authentication Algorithm	HMAC_SHA1_96
SA ESP Encryption Key (outbound)	
SA ESP Authentication Key (outbound)	
SA ESP SPI (outbound)	
SA ESP Encryption Key (inbound)	
SA ESP Authentication Key (inbound)	
SA ESP SPI (inbound)	
SA AH Authentication Algorithm	HMAC_SHA1_96
SA AH Authentication Key (outbound)	
SA AH SPI (outbound)	
SA AH Authentication Key (inbound)	

Item	Setting
SA AH SPI (inbound)	
<ul style="list-style-type: none"> Video Record Settings 	
Video Record Action	Upload
<ul style="list-style-type: none"> Memory Card Operations 	
Operation Settings	Save Logs and Videos
Video Format	JPEG
Pre-event Buffer (number of frames)	0
Post-event Buffer (number of frames)	0
Pre-event Buffer (sec)	0
Post-event Buffer (sec)	0
Overwrite videos	Disable
Auto Video Delete	Disable
Days Saved	30
Delete Time	00:00
<ul style="list-style-type: none"> Initialization 	
Network Settings	Save
<ul style="list-style-type: none"> Backup / Restore 	
Save Destination	Memory Card
<ul style="list-style-type: none"> Update Firmware 	
Restore Default Settings	Do Not Restore
<ul style="list-style-type: none"> Log Notifications 	
Use log notifications	Disable
Notification Level	Error
Mail Server Name	
Mail Server Port	25
Sender (From)	
Recipient (To)	
Authentication	None
User Name	
POP Server	
Subject	

Numerics

802.1X Authentication 211

A

Abandoned Object Detection 172, 184
 Access Restrictions 53
 Adjust Focus 115, 121
 Administrator 53
 Administrator Account 38, 98
 Administrator Password 39, 98
 ADSR 141
 AGC Limit 115
 Aperture 116
 Area Zoom 67
 Audio Detection 83, 166, 174
 Audio Distribution 53, 99
 Audio Input 150
 Audio Multicast 156
 Audio Reception 80, 155
 Audio Server 155
 Audio Transmission 80, 155
 Authentication Method 151, 211
 Authority 99
 Authorized User 53, 98
 Auto Flip 108
 Auto Key Exchange 213
 Auto Tracking 175, 194
 Auto Video Delete 219
 AutoIP 95

B

Back Light Compensation 71
 Back Up Settings 222
 Basic Camera Settings 40
 Bit Rate Control 103

C

Camera Angle 43
 Camera Control 53, 99
 Camera Control Privileges 65
 Camera Control Queue Length 154
 Camera Control Time 154
 Camera Management Tool 22, 37
 Camera Name 107

Camera Operation

Clear IR Mode 71
 Day/Night 71
 Exposure Compensation 70
 Focus 70
 Pan/Tilt 69
 Pan/Tilt Speed 69
 Zoom 69
 Zoom Speed 69

Camera Tampering Detection 173, 187

Camera Viewer 49, 50

Certificate Information 211

Certificate Management 209, 212

Clear IR Mode 71, 110, 118

Client Certificate 211

Color Saturation 118

Control Privileges 65

Current Settings 220

Current Volume Level 166

Custom Installation 31

D

Data Size Reduction Level 142

Date 100

Day Mode 71, 119, 122

Day/Night 71, 109, 119, 121

Day/Night Mode Focus 120

Day/Night Mode Switching 165, 170, 201

Daylight Saving Time 101

Default Gateway Address 95, 96

Default Page 105

Detection Area 177, 192

Detection Criteria 166, 181

Detection Lines 188, 192

Detection Type 172, 178

Detections Settings 192

Device Information 220

Device Name 110, 111

DHCP 94

DHCPv6 95

Digital PTZ 74

Digital Zoom 67, 107

Display Options 192

Display Size 61

DNS 96

Drag to Move 68

E

Easy Installation	31
Echo Cancellor	149
E-mail Notification 162, 164, 167, 168, 170, 199, 203	
Encrypted Communications	209
Enhanced Digital Zoom	67, 107
Error Message	245
Event	199
Event and Input/Output	
Audio Detection	83
Auto Tracking	83
External Device Input	82
External Device Output	82
Image Detection	82
Linked Events	83
Event Display	82, 191
Exposure	115
Exposure Compensation	70, 116
External Device Input	82, 164
External Device Output	163
External Input Device	110
External Output Device	110

F

Factory Default Settings	247, 251
Firewall	33
Firmware	220, 223
Focus	70, 113
Format	219
Frame Rate	104, 157, 159
FTP Server	152
FTP Upload	160
Full Screen Display	62
Full Video Display Area	137

G

Gain	116, 117
Guest User	53, 99

H

H.264 Video	23, 61, 141
H.264(1)	103
H.264(2)	104
Haze Compensation	118
Haze Compensation Strength	108
Home Position	72, 131
Host Access Restrictions	206, 207
HTTP Port	151

HTTP Server	151
HTTP Upload	159
HTTPS Connection Policy	209
HTTPS Port	151

I

I Frame Interval	104
Image Detection	82
Image Stabilizer	108
Information Display	60
Information Message	245
Infrared Filter	119
Infrared Light Level	119
Infrared Light Strength	108
Infrared Light Turn On Time	110
Initial Setting	37, 112
Initialization	220
Input Volume	149
Installation	30
Installation Guide	5
Intelligent Function	
Auto Tracking	194
Detections Settings	192
Display Options	192
Operation Mode	175
Restart	200
Video Detection	177
Intrusion Detection	174, 190
IPsec	213
IPv4	94
IPv4 Address	95
IPv6	95

J

JPEG	62, 103
------------	---------

L

LAN	94
Language Switch Button	86
LED	110
License	220
Linked Event	83, 202
Lock camera position	177
Log	224
Log Messages	232

M

Main	
Language	57
Mobile Camera Viewer	57
Setting Page	57
Switch Users	57
Maintenance	220
Maximum Connection Time	154
Maximum Digital Zoom Magnification	107
Maximum Frame Rate	103
Maximum Number of Clients	154
Maximum Packet Size	94
mDNS	97
Memory Card	20, 21, 217
Memory Card Capacity	219
Memory Card Information	219
Message	
Error Message	245
Information Message	245
Log Message	232
Warning Message	245
Metering Mode	116
Mobile Camera Viewer	5, 22, 26
Modifier	228
Motion-Adaptive Noise Reduction	108
Mounted	217
Moving Object Detection	172, 183
Multicast DNS	97

N

Name Server Address	96
Network	94
Network Address / Subnet	206
Night Mode	71, 119, 122
Noise Reduction	118
Non-Detection Area	179, 192
Notification	159, 160, 162
NTP Server	100

O

One-shot AF	115, 121
One-shot WB	117
On-screen display	143
Operation Mode	163, 164
Operation Settings	218
Output Volume	149
Overwrite videos	218

P

Pan	46, 66, 69
Panorama	123
Panorama Display Panel	69
Panorama Screen	89, 137
Parameter	228
Passing Detection	173, 188
Password	51, 98
Post-event Buffer	159, 218
Pre-event Buffer	159, 218
Prefix	95, 207
Preset	72, 76, 131, 164, 167, 203
Start Time Preset	169
When switching Day/Night Mode	201
Preset Name	133
Preset Selection Menu	72
Preset Tour	135
Privacy Mask	145
Privileged Camera Control	53, 99
Pulse	163

R

Reboot	220
Reconnect	89
Recorded Video Utility	5, 22, 79
Recording Manually	78
Recording to a Memory Card	78
Reference Volume Level	166
Refresh Drive System	220
Removed Object Detection	172, 185
Reset Switch	247
Restore	222
Restore Default Settings	221
Restore Settings	222
RM-Lite	23
Rotate Video Display	105
Rotation	46
RTP	156
RTSP	156

S

Scream Detection	167
Self-Signed Certificate	208
Setting Menus	86, 90
Setting Page	85
Setup CD-ROM	5, 22
Sharpness	118
Shutter Speed	115

Shutter Speed Limit	115
Simple Camera Setting	113
Smart Shade Control	116
Smart Shade Control Level	117
Smart Shade Control Strength	108
Snapshot	77, 89
SNMP Server	151
Sound Clip Upload	150
Specify the initial camera position	194
SSL/TLS Certificate	208
Still Image	77
Subnet Mask	95
Switching an Authorized User	52

T

Target Bit Rate	103
Tilt	46, 66, 69
Time	100
Time Zone	101
Timer	169
Tour Route Settings	138
Tracking Conditions	195
Troubleshooting	230
Trusted Sites	34

U

Unmounted	217
Upload	158
Use Infrared	119
User Account	98
User Authentication	51, 105
User Authority	99
User List	98
User Management	98
User Name	51, 98
User Page	92

V

Video and Audio	
Audio Reception	63
Audio Transmission	63
Display Size Setting	61
H.264	61
Maximum Frame Rate	62
Video Size	61
Video Detection	172, 175, 177
Video Display Area	45, 56, 88
Video Distribution	53, 99
Video Flip	110

Video Format	159, 218
Video Management Information	219
Video Output	93
Video Quality	103
Video Record	164, 167, 168, 169, 203
Video Record Action	158, 217
Video Saving	219
Video Server	154
Video Size	61, 103, 157
Video Size Set	102
View restriction	127
Viewer	
Camera Viewer	22, 49
Mobile Camera Viewer	5, 22
RM-Lite Viewer	23
Viewer Message	245
Viewer PTZ	73
Voice Activity Detection	155
Volume	80, 81, 165, 200
Volume Detection	166

W

Warning Message	245
White Balance	117
WS-Security	153

Z

Zoom	46, 66, 69
------------	------------

